

# **Apache OpenJPA 2.4 User's Guide**

---

# Apache OpenJPA 2.4 User's Guide

Built from OpenJPA version revision 1833087.

Publication date Last updated on June 6, 2018 at 11:07 PM.

Copyright © 2006-2017 The Apache Software Foundation

---

---

1. Introduction .....	1
1. About .....	3
2. Legal .....	4
2.1. License .....	4
2.2. Notice .....	4
2.3. Copyrights .....	4
2.3.1. Apache .....	4
2.3.2. Serp .....	4
2.3.3. Sun .....	4
2.3.4. Other .....	5
2. Java Persistence API .....	6
1. Introduction .....	11
1.1. Intended Audience .....	11
1.2. Lightweight Persistence .....	11
2. Why JPA? .....	12
3. Java Persistence API Architecture .....	14
3.1. JPA Exceptions .....	15
4. Entity .....	17
4.1. Restrictions on Persistent Classes .....	18
4.1.1. Default or No-Arg Constructor .....	18
4.1.2. Final .....	18
4.1.3. Identity Fields .....	18
4.1.4. Version Field .....	18
4.1.5. Inheritance .....	19
4.1.6. Persistent Fields .....	19
4.1.7. Conclusions .....	20
4.2. Entity Identity .....	20
4.2.1. Identity Class .....	21
4.2.1.1. Identity Hierarchies .....	22
4.3. Lifecycle Callbacks .....	23
4.3.1. Callback Methods .....	23
4.3.2. Using Callback Methods .....	24
4.3.3. Using Entity Listeners .....	25
4.3.4. Entity Listeners Hierarchy .....	25
4.4. Conclusions .....	26
5. Metadata .....	27
5.1. Class Metadata .....	28
5.1.1. Entity .....	28
5.1.2. Id Class .....	29
5.1.3. Mapped Superclass .....	29
5.1.4. Embeddable .....	29
5.1.5. EntityListeners .....	30
5.1.6. Example .....	30
5.2. Field and Property Metadata .....	32
5.2.1. Explicit Access .....	32
5.2.2. Transient .....	34
5.2.3. Id .....	34
5.2.4. Generated Value .....	34
5.2.5. Embedded Id .....	35
5.2.6. Version .....	35
5.2.7. Basic .....	35
5.2.7.1. Fetch Type .....	36
5.2.8. Embedded .....	36
5.2.9. Many To One .....	36

---

5.2.9.1. Cascade Type .....	37
5.2.10. One To Many .....	38
5.2.10.1. Bidirectional Relations .....	39
5.2.11. One To One .....	39
5.2.12. Many To Many .....	40
5.2.13. Order By .....	41
5.2.14. Map Key .....	41
5.2.15. Persistent Field Defaults .....	41
5.3. XML Schema .....	42
5.4. Conclusion .....	64
6. Persistence .....	69
6.1. persistence.xml .....	69
6.2. Non-EE Use .....	75
7. EntityManagerFactory .....	76
7.1. Obtaining an EntityManagerFactory .....	76
7.2. Obtaining EntityManagers .....	76
7.3. Persistence Context .....	77
7.3.1. Transaction Persistence Context .....	77
7.3.2. Extended Persistence Context .....	78
7.4. Retrieving Properties Information .....	79
7.5. Closing the EntityManagerFactory .....	79
7.6. PersistenceUnitUtil .....	79
8. EntityManager .....	81
8.1. Transaction Association .....	81
8.2. Entity Lifecycle Management .....	82
8.3. Lifecycle Examples .....	84
8.4. Entity Identity Management .....	86
8.5. Cache Management .....	87
8.6. Query Factory .....	87
8.7. Entity Locking .....	88
8.8. Retrieving Properties Information .....	89
8.9. Closing .....	89
9. Transaction .....	90
9.1. Transaction Types .....	90
9.2. The EntityTransaction Interface .....	91
10. JPA Query .....	93
10.1. JPQL API .....	93
10.1.1. Query Basics .....	93
10.1.2. Relation Traversal .....	96
10.1.3. Embeddable Traversal .....	97
10.1.4. Fetch Joins .....	97
10.1.5. JPQL Functions .....	98
10.1.6. Polymorphic Queries .....	100
10.1.7. Query Parameters .....	100
10.1.8. Query Hints .....	101
10.1.8.1. Locking Hints .....	101
10.1.8.2. Lock Timeout Hint .....	102
10.1.8.3. Query Timeout Hint .....	102
10.1.8.4. Result Set Size Hint .....	102
10.1.8.5. Isolation Level Hint .....	102
10.1.8.6. Other Fetchplan Hints .....	102
10.1.8.7. Database-Specific Hints .....	102
10.1.8.8. Named Query Hints .....	102
10.1.8.9. Handling of Multiple Similar Query Hints .....	103

10.1.9. Ordering .....	103
10.1.10. Aggregates .....	103
10.1.11. Named Queries .....	104
10.1.12. Delete By Query .....	104
10.1.13. Update By Query .....	105
10.2. JPQL Language Reference .....	105
10.2.1. JPQL Statement Types .....	105
10.2.1.1. JPQL Select Statement .....	106
10.2.1.2. JPQL Update and Delete Statements .....	106
10.2.2. JPQL Abstract Schema Types and Query Domains .....	106
10.2.2.1. JPQL Entity Naming .....	107
10.2.2.2. JPQL Schema Example .....	107
10.2.3. JPQL FROM Clause and Navigational Declarations .....	108
10.2.3.1. JPQL FROM Identifiers .....	108
10.2.3.2. JPQL Identification Variables .....	111
10.2.3.3. JPQL Range Declarations .....	112
10.2.3.4. JPQL Path Expressions .....	112
10.2.3.5. JPQL Joins .....	114
10.2.3.5.1. JPQL Inner Joins (Relationship Joins) .....	115
10.2.3.5.2. JPQL Outer Joins .....	116
10.2.3.5.3. JPQL Fetch Joins .....	116
10.2.3.6. JPQL Collection Member Declarations .....	116
10.2.3.7. JPQL FROM Clause and SQL .....	117
10.2.3.8. JPQL Polymorphism .....	117
10.2.4. JPQL WHERE Clause .....	117
10.2.5. JPQL Conditional Expressions .....	118
10.2.5.1. JPQL Literals .....	118
10.2.5.2. JPQL Identification Variables .....	118
10.2.5.3. JPQL Path Expressions .....	119
10.2.5.4. JPQL Input Parameters .....	119
10.2.5.4.1. JPQL Positional Parameters .....	119
10.2.5.4.2. JPQL Named Parameters .....	119
10.2.5.5. JPQL Conditional Expression Composition .....	119
10.2.5.6. JPQL Operators and Operator Precedence .....	120
10.2.5.7. JPQL Comparison Expressions .....	120
10.2.5.8. JPQL Between Expressions .....	121
10.2.5.9. JPQL In Expressions .....	122
10.2.5.10. JPQL Like Expressions .....	122
10.2.5.11. JPQL Null Comparison Expressions .....	123
10.2.5.12. JPQL Empty Collection Comparison Expressions .....	123
10.2.5.13. JPQL Collection Member Expressions .....	124
10.2.5.14. JPQL Exists Expressions .....	124
10.2.5.15. JPQL All or Any Expressions .....	124
10.2.5.16. JPQL Subqueries .....	125
10.2.6. JPQL Scalar Expressions .....	126
10.2.6.1. Arithmetic Expressions .....	126
10.2.6.2. String, Arithmetic, and Datetime Functional Expressions .....	126
10.2.6.2.1. JPQL String Functions .....	126
10.2.6.2.2. JPQL Arithmetic Functions .....	127
10.2.6.2.3. JPQL Datetime Functions .....	127
10.2.6.3. Case Expressions .....	127
10.2.6.4. Entity Type Expressions .....	128
10.2.7. JPQL GROUP BY, HAVING .....	129
10.2.8. JPQL SELECT Clause .....	130

10.2.8.1. JPQL Result Type of the SELECT Clause .....	131
10.2.8.2. JPQL Constructor Expressions .....	132
10.2.8.3. JPQL Null Values in the Query Result .....	132
10.2.8.4. JPQL Embeddables in the Query Result .....	132
10.2.8.5. JPQL Aggregate Functions .....	133
10.2.8.5.1. JPQL Aggregate Examples .....	134
10.2.8.5.2. JPQL Numeric Expressions in the SELECT Clause .....	134
10.2.9. JPQL ORDER BY Clause .....	134
10.2.10. JPQL Bulk Update and Delete .....	136
10.2.11. JPQL Null Values .....	137
10.2.12. JPQL Equality and Comparison Semantics .....	137
10.2.13. JPQL BNF .....	137
11. JPA Criteria .....	142
11.1. Constructing a CriteriaQuery .....	142
11.2. Executing a CriteriaQuery .....	143
11.3. Extension to Criteria API .....	143
11.4. Generation of Canonical MetaModel classes .....	143
12. SQL Queries .....	145
12.1. Creating SQL Queries .....	145
12.2. Retrieving Persistent Objects with SQL .....	145
13. Mapping Metadata .....	147
13.1. Table .....	148
13.2. Unique Constraints .....	150
13.3. Column .....	151
13.4. Identity Mapping .....	152
13.5. Generators .....	154
13.5.1. Sequence Generator .....	154
13.5.2. Table Generator .....	155
13.5.3. Example .....	156
13.6. Inheritance .....	158
13.6.1. Single Table .....	158
13.6.1.1. Advantages .....	159
13.6.1.2. Disadvantages .....	160
13.6.2. Joined .....	160
13.6.2.1. Advantages .....	161
13.6.2.2. Disadvantages .....	162
13.6.3. Table Per Class .....	162
13.6.3.1. Advantages .....	163
13.6.3.2. Disadvantages .....	163
13.6.4. Putting it All Together .....	163
13.7. Discriminator .....	167
13.8. Field Mapping .....	171
13.8.1. Basic Mapping .....	171
13.8.1.1. LOBs .....	172
13.8.1.2. Enumerated .....	172
13.8.1.3. Temporal Types .....	172
13.8.1.4. The Updated Mappings .....	173
13.8.2. Secondary Tables .....	178
13.8.3. Embedded Mapping .....	179
13.8.4. Direct Relations .....	181
13.8.5. Join Table .....	184
13.8.6. Bidirectional Mapping .....	187
13.8.7. Map Mapping .....	187
13.9. The Complete Mappings .....	188

14. Conclusion .....	198
3. Reference Guide .....	199
1. Introduction .....	207
1.1. Intended Audience .....	207
2. Configuration .....	208
2.1. Introduction .....	208
2.2. Runtime Configuration .....	208
2.3. Command Line Configuration .....	208
2.3.1. Code Formatting .....	209
2.4. Plugin Configuration .....	210
2.5. OpenJPA Properties .....	211
2.5.1. openjpa.AutoClear .....	211
2.5.2. openjpa.AutoDetach .....	211
2.5.3. openjpa.BrokerFactory .....	212
2.5.4. openjpa.BrokerImpl .....	212
2.5.5. openjpa.Callbacks .....	212
2.5.6. openjpa.ClassResolver .....	212
2.5.7. openjpa.Compatibility .....	213
2.5.8. openjpa.ConnectionDriverName .....	213
2.5.9. openjpa.Connection2DriverName .....	213
2.5.10. openjpa.ConnectionFactory .....	213
2.5.11. openjpa.ConnectionFactory2 .....	214
2.5.12. openjpa.ConnectionFactoryName .....	214
2.5.13. openjpa.ConnectionFactory2Name .....	214
2.5.14. openjpa.ConnectionFactoryMode .....	214
2.5.15. openjpa.ConnectionFactoryProperties .....	215
2.5.16. openjpa.ConnectionFactory2Properties .....	215
2.5.17. openjpa.ConnectionPassword .....	215
2.5.18. openjpa.Connection2Password .....	215
2.5.19. openjpa.ConnectionProperties .....	216
2.5.20. openjpa.Connection2Properties .....	216
2.5.21. openjpa.ConnectionURL .....	216
2.5.22. openjpa.Connection2URL .....	216
2.5.23. openjpa.ConnectionUserName .....	217
2.5.24. openjpa.Connection2UserName .....	217
2.5.25. openjpa.ConnectionRetainMode .....	217
2.5.26. openjpa.DataCache .....	217
2.5.27. openjpa.DataCacheManager .....	217
2.5.28. openjpa.DataCacheMode .....	218
2.5.29. openjpa.DataCacheTimeout .....	218
2.5.30. openjpa.DetachState .....	218
2.5.31. openjpa.DynamicDataStructs .....	218
2.5.32. openjpa.DynamicEnhancementAgent .....	219
2.5.33. openjpa.FetchBatchSize .....	219
2.5.34. openjpa.EncryptionProvider .....	219
2.5.35. openjpa.FetchGroups .....	220
2.5.36. openjpa.FlushBeforeQueries .....	220
2.5.37. openjpa.IgnoreChanges .....	220
2.5.38. openjpa.Id .....	220
2.5.39. openjpa.InitializeEagerly .....	220
2.5.40. openjpa.Instrumentation .....	221
2.5.41. openjpa.InverseManager .....	221
2.5.42. openjpa.LockManager .....	221
2.5.43. openjpa.LockTimeout .....	222

2.5.44.	openjpa.Log .....	222
2.5.45.	openjpa.ManagedRuntime .....	222
2.5.46.	openjpa.Mapping .....	222
2.5.47.	openjpa.MaxFetchDepth .....	223
2.5.48.	openjpa.MetaDataFactory .....	223
2.5.49.	openjpa.MetaDataRepository .....	223
2.5.50.	openjpa.Multithreaded .....	223
2.5.51.	openjpa.Optimistic .....	224
2.5.52.	openjpa.OptimizeIdCopy .....	224
2.5.53.	openjpa.OrphanedKeyAction .....	224
2.5.54.	openjpa.NontransactionalRead .....	224
2.5.55.	openjpa.NontransactionalWrite .....	225
2.5.56.	openjpa.ProxyManager .....	225
2.5.57.	openjpa.PostLoadOnMerge .....	225
2.5.58.	openjpa.QueryCache .....	225
2.5.59.	openjpa.QueryCompilationCache .....	226
2.5.60.	openjpa.ReadLockLevel .....	226
2.5.61.	openjpa.RemoteCommitProvider .....	226
2.5.62.	openjpa.RestoreState .....	226
2.5.63.	openjpa.RetainState .....	227
2.5.64.	openjpa.RetryClassRegistration .....	227
2.5.65.	openjpa.RuntimeUnenhancedClasses .....	227
2.5.66.	openjpa.SavepointManager .....	228
2.5.67.	openjpa.Sequence .....	228
2.5.68.	openjpa.Specification .....	228
2.5.69.	openjpa.TransactionMode .....	228
2.5.70.	openjpa.UseTCCLinSelectNew .....	229
2.5.71.	openjpa.WriteLockLevel .....	229
2.6.	OpenJPA JDBC Properties .....	229
2.6.1.	openjpa.jdbc.ConnectionDecorators .....	229
2.6.2.	openjpa.jdbc.DBDictionary .....	230
2.6.3.	openjpa.jdbc.DriverDataSource .....	230
2.6.4.	openjpa.jdbc.EagerFetchMode .....	230
2.6.5.	openjpa.jdbc.FetchDirection .....	230
2.6.6.	openjpa.jdbc.JDBCListeners .....	231
2.6.7.	openjpa.jdbc.LRSSize .....	231
2.6.8.	openjpa.jdbc.MappingDefaults .....	231
2.6.9.	openjpa.jdbc.MappingFactory .....	232
2.6.10.	openjpa.jdbc.QuerySQLCache .....	232
2.6.11.	openjpa.jdbc.ResultSetType .....	232
2.6.12.	openjpa.jdbc.Schema .....	232
2.6.13.	openjpa.jdbc.SchemaFactory .....	232
2.6.14.	openjpa.jdbc.Schemas .....	233
2.6.15.	openjpa.jdbc.SQLFactory .....	233
2.6.16.	openjpa.jdbc.SubclassFetchMode .....	233
2.6.17.	openjpa.jdbc.SynchronizeMappings .....	233
2.6.18.	openjpa.jdbc.TransactionIsolation .....	234
2.6.19.	openjpa.jdbc.UpdateManager .....	234
2.6.20.	Compatibility with Specification .....	234
3.	Logging and Auditing .....	236
3.1.	Logging Channels .....	236
3.2.	OpenJPA Logging .....	237
3.3.	Disabling Logging .....	238
3.4.	Log4J .....	238



3.5. Apache Commons Logging .....	238
3.5.1. JDK java.util.logging .....	239
3.6. SLF4J .....	239
3.7. Custom Log .....	239
3.8. OpenJPA Audit .....	240
3.8.1. Configuration .....	240
3.8.2. Developing custom auditing .....	241
4. JDBC .....	243
4.1. Using the OpenJPA DataSource .....	243
4.1.1. Optional Connection Pooling .....	243
4.1.2. Configuring the OpenJPA DataSource .....	243
4.1.3. Configuring Apache Commons DBCP .....	244
4.2. Using a Third-Party DataSource .....	244
4.2.1. Managed and XA DataSources .....	245
4.2.2. Setting the DataSource at runtime .....	245
4.2.2.1. Using different DataSources for each EntityManager .....	246
4.2.2.1.1. Benefits .....	246
4.2.2.1.2. Limitations .....	246
4.2.2.1.3. Error handling .....	246
4.3. Runtime Access to DataSource .....	247
4.4. Database Support .....	247
4.4.1. DBDictionary Properties .....	249
4.4.2. FirebirdDictionary Properties .....	259
4.4.3. MySQLDictionary Properties .....	259
4.4.4. OracleDictionary Properties .....	259
4.4.5. SybaseDictionary Properties .....	260
4.4.6. DB2 Properties .....	260
4.4.7. Delimited Identifiers Support .....	260
4.5. Setting the Transaction Isolation .....	261
4.6. Setting the SQL Join Syntax .....	261
4.7. Accessing Multiple Databases .....	262
4.8. Configuring the Use of JDBC Connections .....	262
4.9. Statement Batching .....	264
4.10. Large Result Sets .....	265
4.11. Default Schema .....	266
4.12. Schema Reflection .....	267
4.12.1. Schemas List .....	267
4.12.2. Schema Factory .....	267
4.13. Schema Tool .....	268
4.14. XML Schema Format .....	271
5. Persistent Classes .....	274
5.1. Persistent Class List .....	274
5.2. Enhancement .....	274
5.2.1. Enhancing at Build Time .....	275
5.2.2. Enhancing JPA Entities on Deployment .....	276
5.2.3. Enhancing at Runtime .....	276
5.2.4. Enhancing Dynamically at Runtime .....	276
5.2.5. Omitting the OpenJPA enhancer .....	277
5.3. Managed Interfaces .....	278
5.4. Object Identity .....	279
5.4.1. Datastore Identity .....	279
5.4.2. Entities as Identity Fields .....	279
5.4.3. Application Identity Tool .....	281
5.4.4. Autoassign / Identity Strategy Caveats .....	282

5.5. Managed Inverses .....	282
5.6. Persistent Fields .....	284
5.6.1. Restoring State .....	284
5.6.2. Typing and Ordering .....	284
5.6.3. Calendar Fields and TimeZones .....	284
5.6.4. Proxies .....	284
5.6.4.1. Smart Proxies .....	284
5.6.4.2. Large Result Set Proxies .....	285
5.6.4.3. Custom Proxies .....	286
5.6.4.4. Serialization .....	287
5.6.5. Externalization .....	287
5.6.5.1. External Values .....	290
5.7. Fetch Groups .....	290
5.7.1. Custom Fetch Groups .....	290
5.7.2. Custom Fetch Group Configuration .....	292
5.7.3. Per-field Fetch Configuration .....	293
5.7.4. Implementation Notes .....	293
5.8. Eager Fetching .....	294
5.8.1. Configuring Eager Fetching .....	295
5.8.2. Eager Fetching Considerations and Limitations .....	296
6. Metadata .....	297
6.1. Metadata Factory .....	297
6.2. Metadata Repository .....	297
6.3. Additional JPA Metadata .....	298
6.3.1. Datastore Identity .....	298
6.3.2. Surrogate Version .....	298
6.3.3. Persistent Field Values .....	298
6.3.4. Persistent Collection Fields .....	299
6.3.5. Persistent Map Fields .....	299
6.4. Metadata Extensions .....	299
6.4.1. Class Extensions .....	299
6.4.1.1. Fetch Groups .....	300
6.4.1.2. Data Cache .....	300
6.4.1.3. Detached State .....	300
6.4.2. Field Extensions .....	300
6.4.2.1. Dependent .....	300
6.4.2.2. Load Fetch Group .....	301
6.4.2.3. LRS .....	301
6.4.2.4. Inverse-Logical .....	301
6.4.2.5. Read-Only .....	301
6.4.2.6. Type .....	301
6.4.2.7. Externalizer .....	302
6.4.2.8. Factory .....	302
6.4.2.9. External Values .....	302
6.4.3. Example .....	302
6.4.4. XML extensions .....	303
7. Mapping .....	304
7.1. Forward Mapping .....	304
7.1.1. Using the Mapping Tool .....	305
7.1.2. Generating DDL SQL .....	306
7.1.3. Runtime Forward Mapping .....	306
7.2. Reverse Mapping .....	307
7.2.1. Customizing Reverse Mapping .....	309
7.3. Meet-in-the-Middle Mapping .....	311

7.4. Mapping Defaults .....	311
7.5. Mapping Factory .....	313
7.6. Non-Standard Joins .....	314
7.7. Additional JPA Mappings .....	315
7.7.1. Datastore Identity Mapping .....	315
7.7.2. Surrogate Version Mapping .....	316
7.7.3. Multi-Column Mappings .....	317
7.7.4. Join Column Attribute Targets .....	317
7.7.5. Embedded Mapping .....	317
7.7.6. Collections .....	319
7.7.6.1. Container Table .....	319
7.7.6.2. Element Join Columns .....	319
7.7.6.3. Order Column .....	320
7.7.7. One-Sided One-Many Mapping .....	320
7.7.8. Maps .....	321
7.7.8.1. Key Columns .....	321
7.7.8.2. Key Join Columns .....	321
7.7.8.3. Key Embedded Mapping .....	321
7.7.8.4. Examples .....	322
7.7.9. Indexes and Constraints .....	322
7.7.9.1. Indexes .....	323
7.7.9.2. Foreign Keys .....	323
7.7.9.3. Unique Constraints .....	323
7.7.10. XML Column Mapping .....	324
7.7.11. LOB Streaming .....	327
7.8. Mapping Limitations .....	328
7.8.1. Table Per Class .....	328
7.9. Mapping Extensions .....	328
7.9.1. Class Extensions .....	329
7.9.1.1. Subclass Fetch Mode .....	329
7.9.1.2. Strategy .....	329
7.9.1.3. Discriminator Strategy .....	329
7.9.1.4. Version Strategy .....	329
7.9.2. Field Extensions .....	329
7.9.2.1. Eager Fetch Mode .....	329
7.9.2.2. Nonpolymorphic .....	329
7.9.2.3. Class Criteria .....	330
7.9.2.4. Strategy .....	330
7.10. Custom Mappings .....	330
7.10.1. Custom Class Mapping .....	330
7.10.2. Custom Discriminator and Version Strategies .....	330
7.10.3. Custom Field Mapping .....	331
7.10.3.1. Value Handlers .....	331
7.10.3.2. Field Strategies .....	331
7.10.3.3. Configuration .....	331
7.11. Orphaned Keys .....	331
8. Deployment .....	333
8.1. Factory Deployment .....	333
8.1.1. Standalone Deployment .....	333
8.1.2. EntityManager Injection .....	333
8.2. Integrating with the Transaction Manager .....	333
8.3. XA Transactions .....	334
8.3.1. Using OpenJPA with XA Transactions .....	334
9. Runtime Extensions .....	335

9.1. Architecture .....	335
9.1.1. Broker Finalization .....	335
9.1.2. Broker Customization and Eviction .....	335
9.2. JPA Extensions .....	336
9.2.1. OpenJPAEntityManagerFactory .....	336
9.2.2. OpenJPAEntityManager .....	336
9.2.3. OpenJPAQuery .....	336
9.2.4. Extent .....	337
9.2.5. StoreCache .....	337
9.2.6. QueryResultCache .....	337
9.2.7. FetchPlan .....	337
9.2.8. OpenJPAEntityTransaction .....	337
9.2.9. OpenJPAPersistence .....	338
9.3. Object Locking .....	338
9.3.1. Configuring Default Locking .....	338
9.3.2. Configuring Lock Levels at Runtime .....	338
9.3.3. Object Locking APIs .....	339
9.3.4. Lock Manager .....	340
9.3.5. Rules for Locking Behavior .....	341
9.3.6. Known Issues and Limitations .....	341
9.4. Savepoints .....	342
9.4.1. Using Savepoints .....	342
9.4.2. Configuring Savepoints .....	343
9.5. MethodQL .....	343
9.6. Generators .....	344
9.6.1. Runtime Access .....	346
9.7. Transaction Events .....	347
9.8. Non-Relational Stores .....	347
10. Caching .....	348
10.1. Data Cache .....	348
10.1.1. Data Cache Configuration .....	348
10.1.1.1. openjpa.DataCache Configuration .....	348
10.1.1.2. Integration with JPA standard shared cache mode .....	351
10.1.1.3. Distributing instances across cache partitions .....	351
10.1.2. Data Cache Usage .....	352
10.1.2.1. Using the JPA standard Cache interface .....	352
10.1.2.2. Using the OpenJPA StoreCache extensions .....	353
10.1.3. Cache Statistics .....	354
10.1.4. Query Cache .....	355
10.1.5. Cache Extension .....	358
10.1.6. Important Notes .....	358
10.1.7. Known Issues and Limitations .....	359
10.2. Query Compilation Cache .....	359
10.3. Prepared SQL Cache .....	360
11. Encryption Provider .....	363
12. Remote and Offline Operation .....	364
12.1. Detach and Attach .....	364
12.1.1. Detach Behavior .....	364
12.1.2. Attach Behavior .....	364
12.1.3. Defining the Detached Object Graph .....	365
12.1.3.1. Detached State .....	365
12.1.3.2. Detached State Field .....	367
12.2. Remote Event Notification Framework .....	367
12.2.1. Remote Commit Provider Configuration .....	367

12.2.1.1. JMS .....	368
12.2.1.2. TCP .....	368
12.2.1.3. Common Properties .....	369
12.2.2. Customization .....	369
13. Slice: Distributed Persistence .....	370
13.1. Overview .....	370
13.2. Salient Features .....	370
13.2.1. Transparency .....	370
13.2.2. Scaling .....	370
13.2.3. Distributed Query .....	370
13.2.4. Data Distribution .....	371
13.2.5. Data Replication .....	372
13.2.6. Heterogeneous Database .....	372
13.2.7. Distributed Transaction .....	372
13.2.8. Collocation Constraint .....	373
13.3. Usage .....	373
13.3.1. How to activate Slice Runtime? .....	373
13.3.2. How to configure each database slice? .....	373
13.3.3. Implement DistributionPolicy interface .....	374
13.3.4. Implement ReplicationPolicy interface .....	375
13.4. Configuration Properties .....	375
13.4.1. Global Properties .....	375
13.4.1.1. openjpa.slice.DistributionPolicy .....	375
13.4.1.2. openjpa.slice.Lenient .....	375
13.4.1.3. openjpa.slice.Master .....	376
13.4.1.4. openjpa.slice.Names .....	376
13.4.1.5. openjpa.slice.ThreadingPolicy .....	376
13.4.1.6. openjpa.slice.TransactionPolicy .....	376
13.4.2. Per-Slice Properties .....	377
14. Third Party Integration .....	378
14.1. Apache Ant .....	378
14.1.1. Common Ant Configuration Options .....	378
14.1.2. Enhancer Ant Task .....	379
14.1.3. Application Identity Tool Ant Task .....	380
14.1.4. Mapping Tool Ant Task .....	381
14.1.5. Reverse Mapping Tool Ant Task .....	381
14.1.6. Schema Tool Ant Task .....	382
14.2. Apache Commons DBCP .....	382
14.2.1. Apache Commons DBCP Configuration Options .....	382
15. Optimization Guidelines .....	384
16. Instrumentation .....	388
16.1. Configuration .....	388
16.1.1. JMX Platform MBean Enablement .....	388
16.2. Custom Providers and Instruments .....	388
4. Appendices .....	390
1. JPA Resources .....	393
2. Supported Databases .....	394
2.1. Overview .....	394
2.2. Verified Database Matrix .....	394
2.3. Compatible Database Matrix .....	394
2.4. Unverified Database Matrix .....	395
2.5. Apache Derby .....	396
2.6. Borland Interbase .....	396
2.6.1. Known issues with Interbase .....	396

2.7. JDataStore .....	396
2.8. IBM DB2 .....	396
2.8.1. Known issues with DB2 .....	396
2.9. Empress .....	397
2.9.1. Known issues with Empress .....	397
2.10. H2 Database Engine .....	397
2.10.1. Known issues with H2 Database Engine .....	397
2.11. Hypersonic .....	398
2.11.1. Known issues with Hypersonic .....	398
2.12. Firebird .....	398
2.12.1. Known issues with Firebird .....	398
2.13. Informix .....	398
2.13.1. Known issues with Informix .....	398
2.14. Ingres Database .....	398
2.14.1. Known issues with Ingres .....	399
2.15. InterSystems Cache .....	399
2.15.1. Known issues with InterSystems Cache .....	399
2.16. Microsoft Access .....	399
2.16.1. Known issues with Microsoft Access .....	399
2.17. Microsoft SQL Server .....	399
2.17.1. Known issues with SQL Server .....	399
2.18. Microsoft FoxPro .....	400
2.18.1. Known issues with Microsoft FoxPro .....	400
2.19. MySQL .....	400
2.19.1. Using Query Hints with MySQL .....	400
2.19.2. Known issues with MySQL .....	401
2.20. Oracle .....	401
2.20.1. Using Query Hints with Oracle .....	401
2.20.2. Known issues with Oracle .....	402
2.21. Pointbase .....	403
2.21.1. Known issues with Pointbase .....	403
2.22. PostgreSQL .....	403
2.22.1. Known issues with PostgreSQL .....	403
2.23. IBM solidDB .....	403
2.23.1. M-type tables vs. D-type tables .....	403
2.23.2. Concurrency control mechanism .....	404
2.24. Sybase Adaptive Server .....	404
2.24.1. Known issues with Sybase .....	404
3. Migration Considerations .....	405
3.1. OpenJPA 2.0.0 .....	405
3.1.1. Incompatibilities .....	405
3.1.1.1. getProperties() .....	405
3.1.1.2. Detach Behavior .....	405
3.1.1.3. Use of private persistent properties .....	405
3.1.1.4. Query.setParameter() .....	406
3.1.1.5. Serialization of Entities .....	406
3.1.1.6. openjpa.jdbc.QuerySQLCache .....	406
3.1.2. Disabling AutoOff Collection Tracking .....	406
3.1.3. Internal Behavioral Differences .....	406
3.1.3.1. PreUpdate/PostUpdate Life Cycle Callbacks .....	407
3.1.3.2. createEntityManagerFactory Exceptions .....	407
3.1.3.3. openjpa.QueryCache default .....	407
3.2. OpenJPA 2.2.0 .....	407
3.2.1. Incompatibilities .....	407

3.2.1.1. allocationSize Property of Sequence Generator .....	407
3.2.1.2. MetaModel Attributes for Arrays .....	408
3.2.1.3. supportsSetClob Property. ....	408
3.2.1.4. useNativeSequenceCache Property. ....	408
3.2.1.5. Cascade persist behavior .....	409
3.2.1.6. Life Cycle Event Manager Callback Behavior .....	409
3.2.1.7. shared-cache-mode Property .....	409
3.3. OpenJPA 2.3.0 .....	409
3.3.1. Incompatibilities .....	409
3.3.1.1. MappingTool Behavior for DB2 and Derby .....	409
3.3.1.2. RequiresSearchStringEscapeForLike DBDictionary Property .....	409
3.3.1.3. Return value of aggregate functions in SELECT clause .....	410

---

## List of Tables

2.1. Persistence Mechanisms .....	12
10.1. Interaction of ReadLockMode hint and LockManager .....	101
2.1. Standard JPA Properties and OpenJPA equivalents .....	211
4.1. Default delimiters for delimited identifiers .....	261
4.2. OpenJPA Automatic Flush Behavior .....	263
5.1. Externalizer Options .....	287
5.2. Factory Options .....	288
10.1. Data access methods .....	348
10.2. Pre-defined aliases .....	359
10.3. Pre-defined aliases .....	360
15.1. Optimization Guidelines .....	384
2.1. Supported Databases and JDBC Drivers .....	394
2.2. Compatible Databases and JDBC Drivers .....	395
2.3. Unverified Databases and JDBC Drivers .....	395



---

## List of Examples

3.1. Interaction of Interfaces Outside Container .....	14
3.2. Interaction of Interfaces Inside Container .....	15
4.1. Persistent Class .....	17
4.2. Identity Class .....	21
5.1. Class Metadata .....	30
5.2. Complete Metadata .....	64
6.1. persistence.xml .....	74
6.2. Obtaining an EntityManagerFactory .....	75
7.1. Behavior of Transaction Persistence Context .....	78
7.2. Behavior of Extended Persistence Context .....	78
8.1. Persisting Objects .....	84
8.2. Updating Objects .....	85
8.3. Removing Objects .....	85
8.4. Detaching and Merging .....	85
9.1. Grouping Operations with Transactions .....	92
10.1. Query Hints .....	101
10.2. Named Query using Hints .....	102
10.3. Setting Multiple Similar Query Hints .....	103
10.4. Delete by Query .....	105
10.5. Update by Query .....	105
12.1. Creating a SQL Query .....	145
12.2. Retrieving Persistent Objects .....	146
12.3. SQL Query Parameters .....	146
13.1. Mapping Classes .....	148
13.2. Defining a Unique Constraint .....	150
13.3. Identity Mapping .....	152
13.4. Generator Mapping .....	156
13.5. Single Table Mapping .....	159
13.6. Joined Subclass Tables .....	161
13.7. Table Per Class Mapping .....	162
13.8. Inheritance Mapping .....	164
13.9. Discriminator Mapping .....	168
13.10. Basic Field Mapping .....	173
13.11. Secondary Table Field Mapping .....	178
13.12. Embedded Field Mapping .....	180
13.13. Mapping Mapped Superclass Field .....	181
13.14. Direct Relation Field Mapping .....	183
13.15. Join Table Mapping .....	185
13.16. Join Table Map Mapping .....	188
13.17. Full Entity Mappings .....	190
2.1. Code Formatting with the Application Id Tool .....	209
3.1. Standard OpenJPA Log Configuration .....	237
3.2. Standard OpenJPA Log Configuration + All SQL Statements .....	238
3.3. Logging to a File .....	238
3.4. Standard Log4J Logging .....	238
3.5. JDK Log Properties .....	239
3.6. Custom Logging Class .....	240
4.1. Properties for the OpenJPA DataSource .....	244
4.2. Properties File for a Third-Party DataSource .....	244
4.3. Managed DataSource Configuration .....	245
4.4. Setting DataSource at Runtime .....	246
4.5. Using the EntityManager's Connection .....	247

4.6. Using the EntityManagerFactory's DataSource .....	247
4.7. Specifying a DBDictionary .....	249
4.8. Specifying a Transaction Isolation .....	261
4.9. Specifying the Join Syntax Default .....	262
4.10. Specifying the Join Syntax at Runtime .....	262
4.11. Specifying Connection Usage Defaults .....	263
4.12. Specifying Connection Usage at Runtime .....	264
4.13. Enable SQL statement batching .....	264
4.14. Disable SQL statement batching .....	264
4.15. Plug-in custom statement batching implementation .....	265
4.16. Specifying Result Set Defaults .....	266
4.17. Specifying Result Set Behavior at Runtime .....	266
4.18. Schema Creation .....	270
4.19. SQL Scripting .....	270
4.20. Table Cleanup .....	270
4.21. Schema Drop .....	270
4.22. Schema Reflection .....	270
4.23. Basic Schema .....	272
4.24. Full Schema .....	272
5.1. Using the OpenJPA Enhancer .....	275
5.2. Using the OpenJPA Agent for Runtime Enhancement .....	276
5.3. Passing Options to the OpenJPA Agent .....	276
5.4. JPA Datastore Identity Metadata .....	279
5.5. Finding an Entity with an Entity Identity Field .....	279
5.6. Id Class for Entity Identity Fields .....	280
5.7. Embedded Id for Entity Identity Fields .....	280
5.8. Using the Application Identity Tool .....	281
5.9. Specifying Logical Inverses .....	283
5.10. Enabling Managed Inverses .....	283
5.11. Log Inconsistencies .....	283
5.12. Using Initial Field Values .....	284
5.13. Using a Large Result Set Iterator .....	285
5.14. Marking a Large Result Set Field .....	286
5.15. Configuring the Proxy Manager .....	287
5.16. Using Externalization .....	289
5.17. Querying Externalization Fields .....	289
5.18. Using External Values .....	290
5.19. Custom Fetch Group Metadata .....	291
5.20. Load Fetch Group Metadata .....	291
5.21. Using the FetchPlan .....	292
5.22. Adding an Eager Field .....	293
5.23. Setting the Default Eager Fetch Mode .....	295
5.24. Setting the Eager Fetch Mode at Runtime .....	295
6.1. Setting a Standard Metadata Factory .....	297
6.2. Setting a Custom Metadata Factory .....	297
6.3. Setting the Preload Property on Metadata Repository .....	298
6.4. OpenJPA Metadata Extensions .....	302
6.5. OpenJPA Schema Extensions .....	303
7.1. Using the Mapping Tool .....	304
7.2. Creating the Relational Schema from Mappings .....	305
7.3. Refreshing entire schema and cleaning out tables .....	305
7.4. Dropping Mappings and Association Schema .....	306
7.5. Create DDL for Current Mappings .....	306
7.6. Create DDL to Update Database for Current Mappings .....	306

7.7. Configuring Runtime Forward Mapping .....	306
7.8. Reflection with the Schema Tool .....	307
7.9. Using the Reverse Mapping Tool .....	307
7.10. Customizing Reverse Mapping with Properties .....	310
7.11. Validating Mappings .....	311
7.12. Configuring Mapping Defaults .....	313
7.13. Standard JPA Configuration .....	313
7.14. Datastore Identity Mapping .....	316
7.15. Overriding Complex Mappings .....	318
7.16. One-Sided One-Many Mapping .....	321
7.17. String Key, Entity Value Map Mapping .....	322
7.18. myaddress.xsd .....	325
7.19. Address.java .....	325
7.20. USAAddress.java .....	326
7.21. CANAddress.java .....	326
7.22. Showing annotated Order entity with XML mapping strategy .....	327
7.23. Showing creation of Order entity having shipAddress mapped to XML column .....	327
7.24. Sample JPQL queries for XML column mapping .....	327
7.25. Annotated InputStream and Reader .....	328
7.26. Custom Logging Orphaned Keys .....	332
8.1. Configuring Transaction Manager Integration .....	334
9.1. Evict from Data Cache .....	336
9.2. Using a JPA Extent .....	337
9.3. Setting Default Lock Levels .....	338
9.4. Setting Runtime Lock Levels .....	339
9.5. Locking APIs .....	339
9.6. Disabling Locking .....	340
9.7. Using Savepoints .....	342
9.8. Named Seq Sequence .....	346
9.9. System Sequence Configuration .....	346
10.1. Single-JVM Data Cache .....	349
10.2. Lru Cache .....	349
10.3. Data Cache Size .....	349
10.4. Data Cache Timeout .....	349
10.5. Excluding entities .....	349
10.6. Including entities .....	350
10.7. Bulk updates and cache eviction .....	350
10.8. ....	351
10.9. ....	351
10.10. ....	351
10.11. Partitioned Data Cache .....	352
10.12. Accessing the Cache .....	352
10.13. Using the javax.persistence.Cache interface .....	352
10.14. Accessing the StoreCache .....	353
10.15. StoreCache Usage .....	354
10.16. Automatic Data Cache Eviction .....	354
10.17. Configuring CacheStatistics .....	354
10.18. Accessing the QueryResultCache .....	355
10.19. Query Cache Size .....	356
10.20. Disabling the Query Cache .....	356
10.21. Query Cache Eviction Policy .....	356
10.22. Evicting Queries .....	357
10.23. Pinning, and Unpinning Query Results .....	357
10.24. Disabling and Enabling Query Caching .....	358

10.25. Query Replaces Extent .....	359
10.26. Hardcoded Selection Value in JPQL Query .....	361
10.27. Parameterized Selection Value in JPQL Query .....	361
12.1. Configuring Detached State .....	366
12.2. JMS Remote Commit Provider Configuration .....	368
12.3. TCP Remote Commit Provider Configuration .....	369
12.4. JMS Remote Commit Provider transmitting Persisted Object Ids .....	369
14.1. Using the <config> Ant Tag .....	378
14.2. Using the Properties Attribute of the <config> Tag .....	378
14.3. Using the PropertiesFile Attribute of the <config> Tag .....	379
14.4. Using the <classpath> Ant Tag .....	379
14.5. Using the <codeformat> Ant Tag .....	379
14.6. Invoking the Enhancer from Ant .....	380
14.7. Invoking the Application Identity Tool from Ant .....	380
14.8. Invoking the Mapping Tool from Ant .....	381
14.9. Invoking the Reverse Mapping Tool from Ant .....	381
14.10. Invoking the Schema Tool from Ant .....	382
14.11. Using Commons DBCP with Apache Derby .....	383
2.1. Example properties for Derby .....	396
2.2. Example properties for Interbase .....	396
2.3. Example properties for JDataStore .....	396
2.4. Example properties for IBM DB2 .....	396
2.5. Example properties for Empress .....	397
2.6. Example properties for H2 Database Engine .....	397
2.7. Example properties for Hypersonic .....	398
2.8. Example properties for Firebird .....	398
2.9. Example properties for Informix Dynamic Server .....	398
2.10. Example properties for Ingres .....	398
2.11. Example properties for InterSystems Cache .....	399
2.12. Example properties for Microsoft Access .....	399
2.13. Example properties for Microsoft SQL Server .....	399
2.14. Example properties for Microsoft FoxPro .....	400
2.15. Example properties for MySQL .....	400
2.16. Using MySQL Hints .....	401
2.17. Example properties for Oracle .....	401
2.18. Using Oracle Hints .....	401
2.19. Property to disable statement batching for Oracle .....	402
2.20. Property to retain connection over the lifetime of the entity manager .....	402
2.21. Example properties for Pointbase .....	403
2.22. Example properties for PostgreSQL .....	403
2.23. Example properties for IBM solidDB .....	403
2.24. Example properties for Sybase .....	404

---

# Part 1. Introduction

---

---

1. About .....	3
2. Legal .....	4
2.1. License .....	4
2.2. Notice .....	4
2.3. Copyrights .....	4
2.3.1. Apache .....	4
2.3.2. Serp .....	4
2.3.3. Sun .....	4
2.3.4. Other .....	5

---

# Chapter 1. About

OpenJPA is Apache's implementation of Java Persistence 2.0 API (JSR-317 JPA 2.0) specification for the transparent persistence of Java objects. This document provides an overview of the JPA standard and technical details on the use of OpenJPA.

This document is intended for OpenJPA users. It is divided into several parts:

- The **JPA Overview** describes the fundamentals of the JPA specification.
- The **OpenJPA Reference Guide** contains detailed documentation on all aspects of OpenJPA. Browse through this guide to familiarize yourself with the many advanced features and customization opportunities OpenJPA provides. Later, you can use the guide when you need details on a specific aspect of OpenJPA.
- Appendices
  - The appendix **JPA Resources** provides links to other resources.
  - The appendix **Supported Databases** provides information on databases supported by OpenJPA.
  - The appendix **Migration Considerations** provides information related to migration to a different release.

---

# Chapter 2. Legal

The Apache OpenJPA website can be found at: <http://openjpa.apache.org>

## 2.1. License

---

Apache OpenJPA is released under the **Apache Software License Version 2.0**

Apache OpenJPA includes the persistence and orm schemas from the JPA specifications and elects to include this software in this distribution under the **CDDL license**.

Apache OpenJPA includes software developed by the SERP project, which uses the **BSD license**

## 2.2. Notice

---

This product includes software developed by **The Apache Software Foundation (<http://www.apache.org/>)**.

The openjpa-all aggregate JAR includes software developed by the:

- Apache Commons Collections project
- Apache Commons Lang project
- Apache Commons Logging project
- Apache Commons Pool project
- Apache Geronimo project (JMS 1.1, JTA 1.1 and JPA 2.0 spec APIs)
- JCP JSR-317 JPA 2.0 schemas
- SERP project

## 2.3. Copyrights

---

### 2.3.1. Apache

---

Copyright (C) 2006,2011 The Apache Software Foundation.

Apache, OpenJPA and the Apache feather logo are trademarks of Apache Software Foundation.

### 2.3.2. Serp

---

OpenJPA includes software developed by the SERP project.

Copyright (c) 2002-2006, A. Abram White. All rights reserved.

### 2.3.3. Sun

---

OpenJPA includes the persistence and orm schemas from the JPA specifications.

Copyright 2005-2009 Sun Microsystems, Inc. All rights reserved.

OpenJPA elects to include this software in this distribution under the CDDL license.



You can obtain a copy of the License at: <https://glassfish.dev.java.net/public/CDDL+GPL.html>

The source code is available at: <http://java.net/projects/glassfish/sources/svn/show> or <http://jcp.org/en/jsr/detail?id=317>

## 2.3.4. Other

---

OpenJPA includes software written by Miroslav Nachev.

OpenJPA uses test code written by Charles Tillman.

Oracle and Java are registered trademarks of Oracle and/or its affiliates. Other names may be trademarks of their respective owners.

---

## **Part 2. Java Persistence API**

---

1. Introduction .....	11
1.1. Intended Audience .....	11
1.2. Lightweight Persistence .....	11
2. Why JPA? .....	12
3. Java Persistence API Architecture .....	14
3.1. JPA Exceptions .....	15
4. Entity .....	17
4.1. Restrictions on Persistent Classes .....	18
4.1.1. Default or No-Arg Constructor .....	18
4.1.2. Final .....	18
4.1.3. Identity Fields .....	18
4.1.4. Version Field .....	18
4.1.5. Inheritance .....	19
4.1.6. Persistent Fields .....	19
4.1.7. Conclusions .....	20
4.2. Entity Identity .....	20
4.2.1. Identity Class .....	21
4.2.1.1. Identity Hierarchies .....	22
4.3. Lifecycle Callbacks .....	23
4.3.1. Callback Methods .....	23
4.3.2. Using Callback Methods .....	24
4.3.3. Using Entity Listeners .....	25
4.3.4. Entity Listeners Hierarchy .....	25
4.4. Conclusions .....	26
5. Metadata .....	27
5.1. Class Metadata .....	28
5.1.1. Entity .....	28
5.1.2. Id Class .....	29
5.1.3. Mapped Superclass .....	29
5.1.4. Embeddable .....	29
5.1.5. EntityListeners .....	30
5.1.6. Example .....	30
5.2. Field and Property Metadata .....	32
5.2.1. Explicit Access .....	32
5.2.2. Transient .....	34
5.2.3. Id .....	34
5.2.4. Generated Value .....	34
5.2.5. Embedded Id .....	35
5.2.6. Version .....	35
5.2.7. Basic .....	35
5.2.7.1. Fetch Type .....	36
5.2.8. Embedded .....	36
5.2.9. Many To One .....	36
5.2.9.1. Cascade Type .....	37
5.2.10. One To Many .....	38
5.2.10.1. Bidirectional Relations .....	39
5.2.11. One To One .....	39
5.2.12. Many To Many .....	40
5.2.13. Order By .....	41
5.2.14. Map Key .....	41
5.2.15. Persistent Field Defaults .....	41
5.3. XML Schema .....	42
5.4. Conclusion .....	64
6. Persistence .....	69

---

6.1. persistence.xml .....	69
6.2. Non-EE Use .....	75
7. EntityManagerFactory .....	76
7.1. Obtaining an EntityManagerFactory .....	76
7.2. Obtaining EntityManagers .....	76
7.3. Persistence Context .....	77
7.3.1. Transaction Persistence Context .....	77
7.3.2. Extended Persistence Context .....	78
7.4. Retrieving Properties Information .....	79
7.5. Closing the EntityManagerFactory .....	79
7.6. PersistenceUnitUtil .....	79
8. EntityManager .....	81
8.1. Transaction Association .....	81
8.2. Entity Lifecycle Management .....	82
8.3. Lifecycle Examples .....	84
8.4. Entity Identity Management .....	86
8.5. Cache Management .....	87
8.6. Query Factory .....	87
8.7. Entity Locking .....	88
8.8. Retrieving Properties Information .....	89
8.9. Closing .....	89
9. Transaction .....	90
9.1. Transaction Types .....	90
9.2. The EntityTransaction Interface .....	91
10. JPA Query .....	93
10.1. JPQL API .....	93
10.1.1. Query Basics .....	93
10.1.2. Relation Traversal .....	96
10.1.3. Embeddable Traversal .....	97
10.1.4. Fetch Joins .....	97
10.1.5. JPQL Functions .....	98
10.1.6. Polymorphic Queries .....	100
10.1.7. Query Parameters .....	100
10.1.8. Query Hints .....	101
10.1.8.1. Locking Hints .....	101
10.1.8.2. Lock Timeout Hint .....	102
10.1.8.3. Query Timeout Hint .....	102
10.1.8.4. Result Set Size Hint .....	102
10.1.8.5. Isolation Level Hint .....	102
10.1.8.6. Other Fetchplan Hints .....	102
10.1.8.7. Database-Specific Hints .....	102
10.1.8.8. Named Query Hints .....	102
10.1.8.9. Handling of Multiple Similar Query Hints .....	103
10.1.9. Ordering .....	103
10.1.10. Aggregates .....	103
10.1.11. Named Queries .....	104
10.1.12. Delete By Query .....	104
10.1.13. Update By Query .....	105
10.2. JPQL Language Reference .....	105
10.2.1. JPQL Statement Types .....	105
10.2.1.1. JPQL Select Statement .....	106
10.2.1.2. JPQL Update and Delete Statements .....	106
10.2.2. JPQL Abstract Schema Types and Query Domains .....	106
10.2.2.1. JPQL Entity Naming .....	107

10.2.2.2. JPQL Schema Example .....	107
10.2.3. JPQL FROM Clause and Navigational Declarations .....	108
10.2.3.1. JPQL FROM Identifiers .....	108
10.2.3.2. JPQL Identification Variables .....	111
10.2.3.3. JPQL Range Declarations .....	112
10.2.3.4. JPQL Path Expressions .....	112
10.2.3.5. JPQL Joins .....	114
10.2.3.5.1. JPQL Inner Joins (Relationship Joins) .....	115
10.2.3.5.2. JPQL Outer Joins .....	116
10.2.3.5.3. JPQL Fetch Joins .....	116
10.2.3.6. JPQL Collection Member Declarations .....	116
10.2.3.7. JPQL FROM Clause and SQL .....	117
10.2.3.8. JPQL Polymorphism .....	117
10.2.4. JPQL WHERE Clause .....	117
10.2.5. JPQL Conditional Expressions .....	118
10.2.5.1. JPQL Literals .....	118
10.2.5.2. JPQL Identification Variables .....	118
10.2.5.3. JPQL Path Expressions .....	119
10.2.5.4. JPQL Input Parameters .....	119
10.2.5.4.1. JPQL Positional Parameters .....	119
10.2.5.4.2. JPQL Named Parameters .....	119
10.2.5.5. JPQL Conditional Expression Composition .....	119
10.2.5.6. JPQL Operators and Operator Precedence .....	120
10.2.5.7. JPQL Comparison Expressions .....	120
10.2.5.8. JPQL Between Expressions .....	121
10.2.5.9. JPQL In Expressions .....	122
10.2.5.10. JPQL Like Expressions .....	122
10.2.5.11. JPQL Null Comparison Expressions .....	123
10.2.5.12. JPQL Empty Collection Comparison Expressions .....	123
10.2.5.13. JPQL Collection Member Expressions .....	124
10.2.5.14. JPQL Exists Expressions .....	124
10.2.5.15. JPQL All or Any Expressions .....	124
10.2.5.16. JPQL Subqueries .....	125
10.2.6. JPQL Scalar Expressions .....	126
10.2.6.1. Arithmetic Expressions .....	126
10.2.6.2. String, Arithmetic, and Datetime Functional Expressions .....	126
10.2.6.2.1. JPQL String Functions .....	126
10.2.6.2.2. JPQL Arithmetic Functions .....	127
10.2.6.2.3. JPQL Datetime Functions .....	127
10.2.6.3. Case Expressions .....	127
10.2.6.4. Entity Type Expressions .....	128
10.2.7. JPQL GROUP BY, HAVING .....	129
10.2.8. JPQL SELECT Clause .....	130
10.2.8.1. JPQL Result Type of the SELECT Clause .....	131
10.2.8.2. JPQL Constructor Expressions .....	132
10.2.8.3. JPQL Null Values in the Query Result .....	132
10.2.8.4. JPQL Embeddables in the Query Result .....	132
10.2.8.5. JPQL Aggregate Functions .....	133
10.2.8.5.1. JPQL Aggregate Examples .....	134
10.2.8.5.2. JPQL Numeric Expressions in the SELECT Clause .....	134
10.2.9. JPQL ORDER BY Clause .....	134
10.2.10. JPQL Bulk Update and Delete .....	136
10.2.11. JPQL Null Values .....	137
10.2.12. JPQL Equality and Comparison Semantics .....	137

10.2.13. JPQL BNF .....	137
11. JPA Criteria .....	142
11.1. Constructing a CriteriaQuery .....	142
11.2. Executing a CriteriaQuery .....	143
11.3. Extension to Criteria API .....	143
11.4. Generation of Canonical MetaModel classes .....	143
12. SQL Queries .....	145
12.1. Creating SQL Queries .....	145
12.2. Retrieving Persistent Objects with SQL .....	145
13. Mapping Metadata .....	147
13.1. Table .....	148
13.2. Unique Constraints .....	150
13.3. Column .....	151
13.4. Identity Mapping .....	152
13.5. Generators .....	154
13.5.1. Sequence Generator .....	154
13.5.2. Table Generator .....	155
13.5.3. Example .....	156
13.6. Inheritance .....	158
13.6.1. Single Table .....	158
13.6.1.1. Advantages .....	159
13.6.1.2. Disadvantages .....	160
13.6.2. Joined .....	160
13.6.2.1. Advantages .....	161
13.6.2.2. Disadvantages .....	162
13.6.3. Table Per Class .....	162
13.6.3.1. Advantages .....	163
13.6.3.2. Disadvantages .....	163
13.6.4. Putting it All Together .....	163
13.7. Discriminator .....	167
13.8. Field Mapping .....	171
13.8.1. Basic Mapping .....	171
13.8.1.1. LOBs .....	172
13.8.1.2. Enumerated .....	172
13.8.1.3. Temporal Types .....	172
13.8.1.4. The Updated Mappings .....	173
13.8.2. Secondary Tables .....	178
13.8.3. Embedded Mapping .....	179
13.8.4. Direct Relations .....	181
13.8.5. Join Table .....	184
13.8.6. Bidirectional Mapping .....	187
13.8.7. Map Mapping .....	187
13.9. The Complete Mappings .....	188
14. Conclusion .....	198

---

# Chapter 1. Introduction

The Java Persistence 2.0 API (JPA 2.0) is a specification for the persistence of Java objects to any relational datastore. This document provides an overview of JPA 2.0. Unless otherwise noted, the information presented applies to all JPA implementations.

## Note

For coverage of OpenJPA's many extensions to the JPA specification, see the [Reference Guide](#).

---

## 1.1. Intended Audience

This document is intended for developers who want to learn about JPA in order to use it in their applications. It assumes that you have a strong knowledge of object-oriented concepts and Java, including annotations and generics. It also assumes some experience with relational databases and the Structured Query Language (SQL).

---

## 1.2. Lightweight Persistence

*Persistent data* is information that can outlive the program that creates it. The majority of complex programs use persistent data: GUI applications need to store user preferences across program invocations, web applications track user movements and orders over long periods of time, etc.

*Lightweight persistence* is the storage and retrieval of persistent data with little or no work from you, the developer. For example, Java serialization is a form of lightweight persistence because it can be used to persist Java objects directly to a file with very little effort. Serialization's capabilities as a lightweight persistence mechanism pale in comparison to those provided by JPA, however. The next chapter compares JPA to serialization and other available persistence mechanisms.

---

# Chapter 2. Why JPA?

Java developers who need to store and retrieve persistent data already have several options available to them: serialization, JDBC, JDO, proprietary object-relational mapping tools, object databases, and EJB 2 entity beans. Why introduce yet another persistence framework? The answer to this question is that with the exception of JDO, each of the aforementioned persistence solutions has severe limitations. JPA attempts to overcome these limitations, as illustrated by the table below.

**Table 2.1. Persistence Mechanisms**

<b>Supports:</b>	<b>Serialization</b>	<b>JDBC</b>	<b>ORM</b>	<b>ODB</b>	<b>EJB 2</b>	<b>JDO</b>	<b>JPA</b>
Java Objects	<b>Yes</b>	No	<b>Yes</b>	<b>Yes</b>	<b>Yes</b>	<b>Yes</b>	<b>Yes</b>
Advanced OO Concepts	<b>Yes</b>	No	<b>Yes</b>	<b>Yes</b>	No	<b>Yes</b>	<b>Yes</b>
Transactional Integrity	No	<b>Yes</b>	<b>Yes</b>	<b>Yes</b>	<b>Yes</b>	<b>Yes</b>	<b>Yes</b>
Concurrency	No	<b>Yes</b>	<b>Yes</b>	<b>Yes</b>	<b>Yes</b>	<b>Yes</b>	<b>Yes</b>
Large Data Sets	No	<b>Yes</b>	<b>Yes</b>	<b>Yes</b>	<b>Yes</b>	<b>Yes</b>	<b>Yes</b>
Existing Schema	No	<b>Yes</b>	<b>Yes</b>	No	<b>Yes</b>	<b>Yes</b>	<b>Yes</b>
Relational and Non-Relational Stores	No	No	No	No	<b>Yes</b>	<b>Yes</b>	No
Queries	No	<b>Yes</b>	<b>Yes</b>	<b>Yes</b>	<b>Yes</b>	<b>Yes</b>	<b>Yes</b>
Strict Standards / Portability	<b>Yes</b>	No	No	No	<b>Yes</b>	<b>Yes</b>	<b>Yes</b>
Simplicity	<b>Yes</b>	<b>Yes</b>	<b>Yes</b>	<b>Yes</b>	No	<b>Yes</b>	<b>Yes</b>

- *Serialization* is Java's built-in mechanism for transforming an object graph into a series of bytes, which can then be sent over the network or stored in a file. Serialization is very easy to use, but it is also very limited. It must store and retrieve the entire object graph at once, making it unsuitable for dealing with large amounts of data. It cannot undo changes that are made to objects if an error occurs while updating information, making it unsuitable for applications that require strict data integrity. Multiple threads or programs cannot read and write the same serialized data concurrently without conflicting with each other. It provides no query capabilities. All these factors make serialization useless for all but the most trivial persistence needs.
- Many developers use the *Java Database Connectivity* (JDBC) APIs to manipulate persistent data in relational databases. JDBC overcomes most of the shortcomings of serialization: it can handle large amounts of data, has mechanisms to ensure data integrity, supports concurrent access to information, and has a sophisticated query language in SQL. Unfortunately, JDBC does not duplicate serialization's ease of use. The relational paradigm used by JDBC was not designed for storing objects, and therefore forces you to either abandon object-oriented programming for the portions of your code that deal with persistent data, or to find a way of mapping object-oriented concepts like inheritance to relational databases yourself.
- There are many proprietary software products that can perform the mapping between objects and relational database tables for you. These *object-relational mapping* (ORM) frameworks allow you to focus on the object model and not concern yourself with the mismatch between the object-oriented and relational paradigms. Unfortunately, each of these product has its own set of APIs. Your code becomes tied to the proprietary interfaces of a single vendor. If the vendor raises prices, fails to fix show-stopping bugs, or falls behind in features, you cannot switch to another product without rewriting all of your persistence code. This is referred to as vendor lock-in.



- Rather than map objects to relational databases, some software companies have developed a form of database designed specifically to store objects. These *object databases* (ODBs) are often much easier to use than object-relational mapping software. The Object Database Management Group (ODMG) was formed to create a standard API for accessing object databases; few object database vendors, however, comply with the ODMG's recommendations. Thus, vendor lock-in plagues object databases as well. Many companies are also hesitant to switch from tried-and-true relational systems to the relatively unknown object database technology. Fewer data-analysis tools are available for object database systems, and there are vast quantities of data already stored in older relational databases. For all of these reasons and more, object databases have not caught on as well as their creators hoped.
- The Enterprise Edition of the Java platform introduced entity Enterprise Java Beans (EJBs). EJB 2.x entities are components that represent persistent information in a datastore. Like object-relational mapping solutions, EJB 2.x entities provide an object-oriented view of persistent data. Unlike object-relational software, however, EJB 2.x entities are not limited to relational databases; the persistent information they represent may come from an Enterprise Information System (EIS) or other storage device. Also, EJB 2.x entities use a strict standard, making them portable across vendors. Unfortunately, the EJB 2.x standard is somewhat limited in the object-oriented concepts it can represent. Advanced features like inheritance, polymorphism, and complex relations are absent. Additionally, EJB 2.x entities are difficult to code, and they require heavyweight and often expensive application servers to run.
- The JDO specification uses an API that is strikingly similar to JPA. JDO, however, supports non-relational databases, a feature that some argue dilutes the specification.

JPA combines the best features from each of the persistence mechanisms listed above. Creating entities under JPA is as simple as creating serializable classes. JPA supports the large data sets, data consistency, concurrent use, and query capabilities of JDBC. Like object-relational software and object databases, JPA allows the use of advanced object-oriented concepts such as inheritance. JPA avoids vendor lock-in by relying on a strict specification like JDO and EJB 2.x entities. JPA focuses on relational databases. And like JDO, JPA is extremely easy to use.

### Note

OpenJPA typically stores data in relational databases, but can be customized for use with non-relational datastores as well.

JPA is not ideal for every application. For many applications, though, it provides an exciting alternative to other persistence mechanisms.

# Chapter 3. Java Persistence API Architecture

The diagram below illustrates the relationships between the primary components of the JPA architecture.

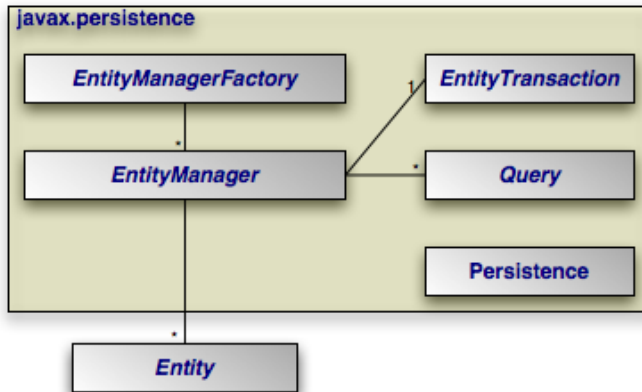

## Note

A number of the depicted interfaces are only required outside of an EJB3-compliant application server. In an application server, `EntityManager` instances are typically injected, rendering the `EntityManagerFactory` unnecessary. Also, transactions within an application server are handled using standard application server transaction controls. Thus, the `EntityTransaction` also goes unused.

- **Persistence:** The `javax.persistence.Persistence` class contains static helper methods to obtain `EntityManagerFactory` instances in a vendor-neutral fashion.
- **EntityManagerFactory:** The `javax.persistence.EntityManagerFactory` class is a factory for `EntityManager`s.
- **EntityManager:** The `javax.persistence.EntityManager` is the primary JPA interface used by applications. Each `EntityManager` manages a set of persistent objects, and has APIs to insert new objects and delete existing ones. When used outside the container, there is a one-to-one relationship between an `EntityManager` and an `EntityTransaction`. `EntityManager`s also act as factories for `Query` instances.
- **Entity:** Entities are persistent objects that represent datastore records.
- **EntityTransaction:** Each `EntityManager` has a one-to-one relation with a single `javax.persistence.EntityTransaction`. `EntityTransactions` allow operations on persistent data to be grouped into units of work that either completely succeed or completely fail, leaving the datastore in its original state. These all-or-nothing operations are important for maintaining data integrity.
- **Query:** The `javax.persistence.Query` interface is implemented by each JPA vendor to find persistent objects that meet certain criteria. JPA standardizes support for queries using both the Java Persistence Query Language (JPQL) and the Structured Query Language (SQL). You obtain `Query` instances from an `EntityManager`.

The example below illustrates how the JPA interfaces interact to execute a JPQL query and update persistent objects. The example assumes execution outside a container.

### Example 3.1. Interaction of Interfaces Outside Container

```

// get an EntityManagerFactory using the Persistence class
// It is not recommended to obtain a factory often, as construction of a
// factory is a costly operation. Typically you will like to cache
// a factory and then refer it for repeated use
EntityManagerFactory factory = Persistence.createEntityManagerFactory(null);

// get an EntityManager from the factory
EntityManager em = factory.createEntityManager();

// Begin a transaction
em.getTransaction().begin();

// query for all employees who work in our research division
// and put in over 40 hours a week average
Query query = em.createQuery("SELECT e " +
    " FROM Employee e " +
    " WHERE e.division.name = 'Research' " +
    " AND e.avgHours > 40");

List results = query.getResultList();

// give all those hard-working employees a raise
for (Object res : results) {
    Employee emp = (Employee) res;
    emp.setSalary(emp.getSalary() * 1.1);
}

// commit will detect all updated entities and save them in database
em.getTransaction().commit();

// free the resources
em.close();

```

Within a container, the `EntityManager` will be injected and transactions will be handled declaratively. Thus, the in-container version of the example consists entirely of business logic:

### *Example 3.2. Interaction of Interfaces Inside Container*

```

// query for all employees who work in our research division
// and put in over 40 hours a week average - note that the EntityManager em
// is injected using a @Resource annotation
Query query = em.createQuery("select e from Employee e where "
    + "e.division.name = 'Research' and e.avgHours > 40");
List results = query.getResultList();

// give all those hard-working employees a raise
for (Object res : results) {
    emp = (Employee) res;
    emp.setSalary(emp.getSalary() * 1.1);
}

```

The remainder of this document explores the JPA interfaces in detail. We present them in roughly the order that you will use them as you develop your application.

## 3.1. JPA Exceptions

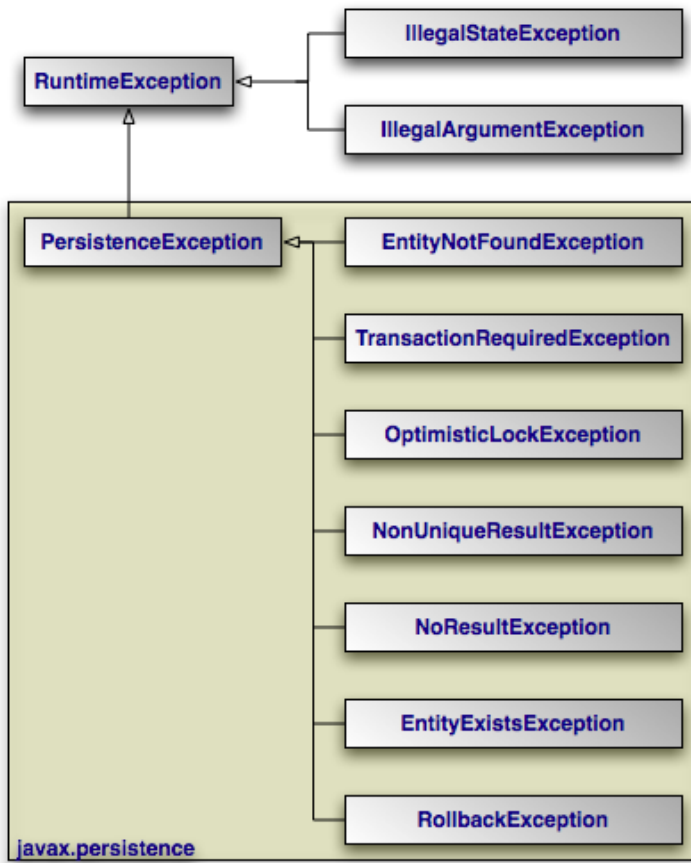

The diagram above depicts the JPA exception architecture. All exceptions are unchecked. JPA uses standard exceptions where appropriate, most notably `IllegalArgumentException`s and `IllegalStateException`s. The specification also provides a few JPA-specific exceptions in the `javax.persistence` package. These exceptions should be self-explanatory. See the **Javadoc** for additional details on JPA exceptions.

## Note

All exceptions thrown by OpenJPA implement `org.apache.openjpa.util.ExceptionInfo` to provide you with additional error information.

# Chapter 4. Entity

JPA recognizes two types of persistent classes: *entity* classes and *embeddable* classes. Each persistent instance of an entity class - each *entity* - represents a unique datastore record. You can use the `EntityManager` to find an entity by its persistent identity (covered later in this chapter), or use a `Query` to find entities matching certain criteria.

An instance of an embeddable class, on the other hand, is only stored as part of a separate entity. Embeddable instances have no persistent identity, and are never returned directly from the `EntityManager` or from a `Query` unless the query uses a projection on owning class to the embedded instance. For example, if `Address` is embedded in `Company`, then a query `"SELECT a FROM Address a"` will never return the embedded `Address` of `Company`; but a projection query such as `"SELECT c.address FROM Company c"` will.

Despite these differences, there are few distinctions between entity classes and embeddable classes. In fact, writing either type of persistent class is a lot like writing any other class. There are no special parent classes to extend from, field types to use, or methods to write. This is one important way in which JPA makes persistence transparent to you, the developer.

## Note

JPA supports both fields and JavaBean properties as persistent state. For simplicity, however, we will refer to all persistent state as persistent fields, unless we want to note a unique aspect of persistent properties.

### Example 4.1. Persistent Class

```
package org.mag;

/**
 * Example persistent class. Notice that it looks exactly like any other
 * class. JPA makes writing persistent classes completely transparent.
 */
public class Magazine {

    private String isbn;
    private String title;
    private Set articles = new HashSet();
    private Article coverArticle;
    private int copiesSold;
    private double price;
    private Company publisher;
    private int version;

    protected Magazine() {
    }

    public Magazine(String title, String isbn) {
        this.title = title;
        this.isbn = isbn;
    }

    public void publish(Company publisher, double price) {
        this.publisher = publisher;
        publisher.addMagazine(this);
        this.price = price;
    }

    public void sell() {
        copiesSold++;
        publisher.addRevenue(price);
    }

    public void addArticle(Article article) {
        articles.add(article);
    }
}
```

```

} // rest of methods omitted

```

## 4.1. Restrictions on Persistent Classes

There are very few restrictions placed on persistent classes. Still, it never hurts to familiarize yourself with exactly what JPA does and does not support.

### 4.1.1. Default or No-Arg Constructor

The JPA specification requires that all persistent classes have a no-arg constructor. This constructor may be public or protected. Because the compiler automatically creates a default no-arg constructor when no other constructor is defined, only classes that define constructors must also include a no-arg constructor.

#### Note

OpenJPA's *enhancer* will automatically add a protected no-arg constructor to your class when required. Therefore, this restriction does not apply when using the enhancer. See [Section 5.2, “Enhancement” \[274\]](#) of the Reference Guide for details.

### 4.1.2. Final

Entity classes may not be final. No method of an entity class can be final.

#### Note

OpenJPA supports final classes and final methods.

### 4.1.3. Identity Fields

All entity classes must declare one or more fields which together form the persistent identity of an instance. These are called *identity* or *primary key* fields. In our `Magazine` class, `isbn` and `title` are identity fields, because no two magazine records in the datastore can have the same `isbn` and `title` values. [Section 5.2.3, “Id” \[34\]](#) will show you how to denote your identity fields in JPA metadata. [Section 4.2, “Entity Identity” \[20\]](#) below examines persistent identity.

#### Note

OpenJPA fully supports identity fields, but does not require them. See [Section 5.4, “Object Identity” \[279\]](#) of the Reference Guide for details.

### 4.1.4. Version Field

The `version` field in our `Magazine` class may seem out of place. JPA uses a version field in your entities to detect concurrent modifications to the same datastore record. When the JPA runtime detects an attempt to concurrently modify the same record, it throws an exception to the transaction attempting to commit last. This prevents overwriting the previous commit with stale data.

A version field is not required, but without one concurrent threads or processes might succeed in making conflicting changes to the same record at the same time. This is unacceptable to most applications. [Section 5.2.6, “Version” \[35\]](#) shows you how to designate a version field in JPA metadata.

The version field must be an integral type ( `int`, `Long`, etc) or a `java.sql.Timestamp`. You should consider version fields immutable. Changing the field value has undefined results.

### Note

OpenJPA fully supports version fields, but does not require them within the actual entity for concurrency detection. OpenJPA can maintain surrogate version values or use state comparisons to detect concurrent modifications. See [Section 7.7, “Additional JPA Mappings” \[315\]](#) in the Reference Guide.

## 4.1.5. Inheritance

JPA fully supports inheritance in persistent classes. It allows persistent classes to inherit from non-persistent classes, persistent classes to inherit from other persistent classes, and non-persistent classes to inherit from persistent classes. It is even possible to form inheritance hierarchies in which persistence skips generations. There are, however, a few important limitations:

- Persistent classes cannot inherit from certain natively-implemented system classes such as `java.net.Socket` and `java.lang.Thread`.
- If a persistent class inherits from a non-persistent class, the fields of the non-persistent superclass cannot be persisted.
- All classes in an inheritance tree must use the same identity type. We cover entity identity in [Section 4.2, “Entity Identity” \[20\]](#).

## 4.1.6. Persistent Fields

JPA manages the state of all persistent fields. Before you access persistent state, the JPA runtime makes sure that it has been loaded from the datastore. When you set a field, the runtime records that it has changed so that the new value will be persisted. This allows you to treat the field in exactly the same way you treat any other field - another aspect of JPA's transparency.

JPA does not support static or final fields. It does, however, include built-in support for most common field types. These types can be roughly divided into three categories: immutable types, mutable types, and relations.

*Immutable* types, once created, cannot be changed. The only way to alter a persistent field of an immutable type is to assign a new value to the field. JPA supports the following immutable types:

- All primitives (`int`, `float`, `byte`, etc)
- All primitive wrappers (`java.lang.Integer`, `java.lang.Float`, `java.lang.Byte`, etc)
- `java.lang.String`
- `java.math.BigInteger`
- `java.math.BigDecimal`

JPA also supports `byte[]`, `Byte[]`, `char[]`, and `Character[]` as immutable types. That is, you can persist fields of these types, but you should not manipulate individual array indexes without resetting the array into the persistent field.

Persistent fields of *mutable* types can be altered without assigning the field a new value. Mutable types can be modified directly through their own methods. The JPA specification requires that implementations support the following mutable field types:

- `java.util.Date`
- `java.util.Calendar`
- `java.sql.Date`

- `java.sql.Timestamp`
- `java.sql.Time`
- Enums
- Entity types (relations between entities)
- Embeddable types
- `java.util.Collections` of entities
- `java.util.Sets` of entities
- `java.util.Lists` of entities
- `java.util.Maps` in which each entry maps the value of one of a related entity's fields to that entity.

Collection and map types may be parameterized.

Most JPA implementations also have support for persisting serializable values as binary data in the datastore. **Chapter 5, *Metadata* [27]** has more information on persisting serializable types.

### Note

OpenJPA also supports arrays, `java.lang.Number`, `java.util.Locale`, all JDK 1.2 `Set`, `List`, and `Map` types, and many other mutable and immutable field types. OpenJPA also allows you to plug in support for custom types.

## 4.1.7. Conclusions

This section detailed all of the restrictions JPA places on persistent classes. While it may seem like we presented a lot of information, you will seldom find yourself hindered by these restrictions in practice. Additionally, there are often ways of using JPA's other features to circumvent any limitations you run into.

## 4.2. Entity Identity

Java recognizes two forms of object identity: numeric identity and qualitative identity. If two references are *numerically* identical, then they refer to the same JVM instance in memory. You can test for this using the `==` operator. *Qualitative* identity, on the other hand, relies on some user-defined criteria to determine whether two objects are "equal". You test for qualitative identity using the `equals` method. By default, this method simply relies on numeric identity.

JPA introduces another form of object identity, called *entity identity* or *persistent identity*. Entity identity tests whether two persistent objects represent the same state in the datastore.

The entity identity of each persistent instance is encapsulated in its *identity field(s)*. If two entities of the same type have the same identity field values, then the two entities represent the same state in the datastore. Each entity's identity field values must be unique among all other entities of the same type.

Identity fields must be primitives, primitive wrappers, `Strings`, `Dates`, `Timestamps`, or embeddable types.

### Note

OpenJPA supports entities as identity fields, as the Reference Guide discusses in **Section 5.4.2, “Entities as Identity Fields” [279]**. For legacy schemas with binary primary key columns, OpenJPA also supports using identity fields of type `byte[]`. When you use a `byte[]` identity field, you must create an identity class. Identity classes are covered below.



## Warning

Changing the fields of an embeddable instance while it is assigned to an identity field has undefined results. Always treat embeddable identity instances as immutable objects in your applications.

If you are dealing with a single persistence context (see [Section 7.3, “Persistence Context” \[77\]](#)), then you do not have to compare identity fields to test whether two entity references represent the same state in the datastore. There is a much easier way: the `==` operator. JPA requires that each persistence context maintain only one JVM object to represent each unique datastore record. Thus, entity identity is equivalent to numeric identity within a persistence context. This is referred to as the *uniqueness requirement*.

The uniqueness requirement is extremely important - without it, it would be impossible to maintain data integrity. Think of what could happen if two different objects in the same transaction were allowed to represent the same persistent data. If you made different modifications to each of these objects, which set of changes should be written to the datastore? How would your application logic handle seeing two different "versions" of the same data? Thanks to the uniqueness requirement, these questions do not have to be answered.

### 4.2.1. Identity Class

If your entity has only one identity field, you can use the value of that field as the entity's identity object in all [EntityManager](#) APIs. Otherwise, you must supply an identity class to use for identity objects. Your identity class must meet the following criteria:

- The class must be public.
- The class must be serializable.
- The class must have a public no-args constructor.
- The names of the non-static fields or properties of the class must be the same as the names of the identity fields or properties of the corresponding entity class, and the types must be identical.
- The `equals` and `hashCode` methods of the class must use the values of all fields or properties corresponding to identity fields or properties in the entity class.
- If the class is an inner class, it must be `static`.
- All entity classes related by inheritance must use the same identity class, or else each entity class must have its own identity class whose inheritance hierarchy mirrors the inheritance hierarchy of the owning entity classes (see [Section 4.2.1.1, “Identity Hierarchies” \[22\]](#)).

## Note

Though you may still create identity classes by hand, OpenJPA provides the `appidtool` to automatically generate proper identity classes based on your identity fields. See [Section 5.4.3, “Application Identity Tool” \[281\]](#) of the Reference Guide.

#### *Example 4.2. Identity Class*

This example illustrates a proper identity class for an entity with multiple identity fields.

```
/**
 * Persistent class using application identity.
```

```

*/
public class Magazine {

    private String isbn;    // identity field
    private String title;  // identity field

    // rest of fields and methods omitted

    /**
     * Application identity class for Magazine.
     */
    public static class MagazineId {

        // each identity field in the Magazine class must have a
        // corresponding field in the identity class
        public String isbn;
        public String title;

        /**
         * Equality must be implemented in terms of identity field
         * equality, and must use instanceof rather than comparing
         * classes directly (some JPA implementations may subclass the
         * identity class).
         */
        public boolean equals(Object other) {
            if (other == this)
                return true;
            if (!(other instanceof MagazineId))
                return false;

            MagazineId mi = (MagazineId) other;
            return (isbn == mi.isbn
                || (isbn != null && isbn.equals(mi.isbn)))
                && (title == mi.title
                || (title != null && title.equals(mi.title)));
        }

        /**
         * Hashcode must also depend on identity values.
         */
        public int hashCode() {
            return ((isbn == null) ? 0 : isbn.hashCode())
                ^ ((title == null) ? 0 : title.hashCode());
        }

        public String toString() {
            return isbn + ":" + title;
        }
    }
}

```

### 4.2.1.1. Identity Hierarchies

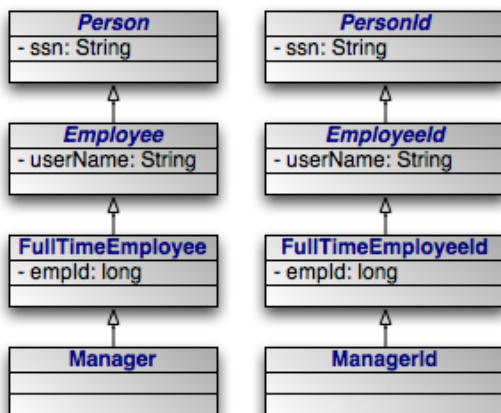

An alternative to having a single identity class for an entire inheritance hierarchy is to have one identity class per level in the inheritance hierarchy. The requirements for using a hierarchy of identity classes are as follows:

- The inheritance hierarchy of identity classes must exactly mirror the hierarchy of the persistent classes that they identify. In the example pictured above, abstract class `Person` is extended by abstract class `Employee`, which is extended by non-abstract class `FullTimeEmployee`, which is extended by non-abstract class `Manager`. The corresponding identity classes, then, are an abstract `PersonId` class, extended by an abstract `EmployeeId` class, extended by a non-abstract `FullTimeEmployeeId` class, extended by a non-abstract `ManagerId` class.
- Subclasses in the identity hierarchy may define additional identity fields until the hierarchy becomes non-abstract. In the aforementioned example, `Person` defines an identity field `ssn`, `Employee` defines additional identity field `userName`, and `FullTimeEmployee` adds a final identity field, `empId`. However, `Manager` may not define any additional identity fields, since it is a subclass of a non-abstract class. The hierarchy of identity classes, of course, must match the identity field definitions of the persistent class hierarchy.
- It is not necessary for each abstract class to declare identity fields. In the previous example, the abstract `Person` and `Employee` classes could declare no identity fields, and the first concrete subclass `FullTimeEmployee` could define one or more identity fields.
- All subclasses of a concrete identity class must be `equals` and `hashCode`-compatible with the concrete superclass. This means that in our example, a `ManagerId` instance and a `FullTimeEmployeeId` instance with the same identity field values should have the same hash code, and should compare equal to each other using the `equals` method of either one. In practice, this requirement reduces to the following coding practices:
  1. Use `instanceof` instead of comparing `Class` objects in the `equals` methods of your identity classes.
  2. An identity class that extends another non-abstract identity class should not override `equals` or `hashCode`.

## 4.3. Lifecycle Callbacks

---

It is often necessary to perform various actions at different stages of a persistent object's lifecycle. JPA includes a variety of callback methods for monitoring changes in the lifecycle of your persistent objects. These callbacks can be defined on the persistent classes themselves and on non-persistent listener classes.

### 4.3.1. Callback Methods

---

Every persistence event has a corresponding callback method marker. These markers are shared between persistent classes and their listeners. You can use these markers to designate a method for callback either by annotating that method or by listing the method in the XML mapping file for a given class. The lifecycle events and their corresponding method markers are:

- **PrePersist:** Methods marked with this annotation will be invoked before an object is persisted. This could be used for assigning primary key values to persistent objects. This is equivalent to the XML element tag `pre-persist`.
- **PostPersist:** Methods marked with this annotation will be invoked after an object has transitioned to the persistent state. You might want to use such methods to update a screen after a new row is added. This is equivalent to the XML element tag `post-persist`.
- **PostLoad:** Methods marked with this annotation will be invoked after all eagerly fetched fields of your class have been loaded from the datastore. No other persistent fields can be accessed in this method. This is equivalent to the XML element tag `post-load`.

`PostLoad` is often used to initialize non-persistent fields whose values depend on the values of persistent fields, such as a complex data structure.

- **PreUpdate:** Methods marked with this annotation will be invoked just the persistent values in your objects are flushed to the datastore. This is equivalent to the XML element tag `pre-update`.

`PreUpdate` is the complement to `PostLoad`. While methods marked with `PostLoad` are most often used to initialize non-persistent values from persistent data, methods annotated with `PreUpdate` is normally used to set persistent fields with information cached in non-persistent data.

- **PostUpdate:** Methods marked with this annotation will be invoked after changes to a given instance have been stored to the datastore. This is useful for clearing stale data cached at the application layer. This is equivalent to the XML element tag `post-update`.
- **PreRemove:** Methods marked with this annotation will be invoked before an object transactions to the deleted state. Access to persistent fields is valid within this method. You might use this method to cascade the deletion to related objects based on complex criteria, or to perform other cleanup. This is equivalent to the XML element tag `pre-remove`.
- **PostRemove:** Methods marked with this annotation will be invoked after an object has been marked as to be deleted. This is equivalent to the XML element tag `post-remove`.

## 4.3.2. Using Callback Methods

When declaring callback methods on a persistent class, any method may be used which takes no arguments and is not shared with any property access fields. Multiple events can be assigned to a single method as well.

Below is an example of how to declare callback methods on persistent classes:

```
/**
 * Example persistent class declaring our entity listener.
 */
@Entity
public class Magazine {

    @Transient
    private byte[][] data;

    @ManyToMany
    private List<Photo> photos;

    @PostLoad
    public void convertPhotos() {
        data = new byte[photos.size()][];
        for (int i = 0; i < photos.size(); i++)
            data[i] = photos.get(i).toByteArray();
    }

    @PreDelete
    public void logMagazineDeletion() {
        getLog().debug("deleting magazine containing" + photos.size()
            + " photos.");
    }
}
```

In an XML mapping file, we can define the same methods without annotations:

```
<entity class="Magazine">
  <pre-remove>logMagazineDeletion</pre-remove>
  <post-load>convertPhotos</post-load>
</entity>
```

## Note

We fully explore persistence metadata annotations and XML in [Chapter 5, \*Metadata\* \[27\]](#).

### 4.3.3. Using Entity Listeners

Mixing lifecycle event code into your persistent classes is not always ideal. It is often more elegant to handle cross-cutting lifecycle events in a non-persistent listener class. JPA allows for this, requiring only that listener classes have a public no-arg constructor. Like persistent classes, your listener classes can consume any number of callbacks. The callback methods must take in a single `java.lang.Object` argument which represents the persistent object that triggered the event.

Entities can enumerate listeners using the `EntityListeners` annotation. This annotation takes an array of listener classes as its value.

Below is an example of how to declare an entity and its corresponding listener classes.

```
/**
 * Example persistent class declaring our entity listener.
 */
@Entity
@EntityListeners({ MagazineLogger.class, ... })
public class Magazine {

    // ... //
}

/**
 * Example entity listener.
 */
public class MagazineLogger {

    @PostPersist
    public void logAddition(Object pc) {
        getLog().debug("Added new magazine:" + ((Magazine) pc).getTitle());
    }

    @PreRemove
    public void logDeletion(Object pc) {
        getLog().debug("Removing from circulation:" +
            ((Magazine) pc).getTitle());
    }
}
```

In XML, we define both the listeners and their callback methods as so:

```
<entity class="Magazine">
  <entity-listeners>
    <entity-listener class="MagazineLogger">
      <post-persist>logAddition</post-persist>
      <pre-remove>logDeletion</pre-remove>
    </entity-listener>
  </entity-listeners>
</entity>
```

### 4.3.4. Entity Listeners Hierarchy

Entity listener methods are invoked in a specific order when a given event is fired. So-called *default* listeners are invoked first: these are listeners which have been defined in a package annotation or in the root element of XML mapping files. Next, entity listeners are invoked in the order of the inheritance hierarchy, with superclass listeners being invoked before subclass listeners. Finally, if an entity has multiple listeners for the same event, the listeners are invoked in declaration order.

You can exclude default listeners and listeners defined in superclasses from the invocation chain through the use of two class-level annotations:

- `ExcludeDefaultListeners`: This annotation indicates that no default listeners will be invoked for this class, or any of its subclasses. The XML equivalent is the empty `exclude-default-listeners` element.
- `ExcludeSuperclassListeners`: This annotation will cause OpenJPA to skip invoking any listeners declared in superclasses. The XML equivalent is the empty `exclude-superclass-listeners` element.

## 4.4. Conclusions

---

This chapter covered everything you need to know to write persistent class definitions in JPA. JPA cannot use your persistent classes, however, until you complete one additional step: you must define the persistence metadata. The next chapter explores metadata in detail.

---

# Chapter 5. Metadata

JPA requires that you accompany each persistent class with persistence metadata. This metadata serves three primary purposes:

1. To identify persistent classes.
2. To override default JPA behavior.
3. To provide the JPA implementation with information that it cannot glean from simply reflecting on the persistent class.

Persistence metadata is specified using either the Java annotations defined in the `javax.persistence` package, XML mapping files, or a mixture of both. In the latter case, XML declarations override conflicting annotations. If you choose to use XML metadata, the XML files must be available at development and runtime, and must be discoverable via either of two strategies:

1. In a resource named `orm.xml` placed in a `META-INF` directory within a directory in your classpath or within a jar archive containing your persistent classes.
2. Declared in your `persistence.xml` configuration file. In this case, each XML metadata file must be listed in a `mapping-file` element whose content is either a path to the given file or a resource location available to the class' class loader.

We describe the standard metadata annotations and XML equivalents throughout this chapter. The full schema for XML mapping files is available in [Section 5.3, “XML Schema” \[42\]](#). JPA also standardizes relational mapping metadata and named query metadata, which we discuss in [Chapter 13, Mapping Metadata \[147\]](#) and [Section 10.1.11, “Named Queries” \[104\]](#) respectively.

## Note

OpenJPA defines many useful annotations beyond the standard set. See [Section 6.3, “Additional JPA Metadata” \[298\]](#) and [Section 6.4, “Metadata Extensions” \[299\]](#) in the Reference Guide for details. There are currently no XML equivalents for these extension annotations.

## Note

Persistence metadata may be used to validate the contents of your entities prior to communicating with the database. This differs from mapping meta data which is primarily used for schema generation. For example if you indicate that a relationship is not optional (e.g. `@Basic(optional=false)`) OpenJPA will validate that the variable in your entity is not null *before* inserting a row in the database.

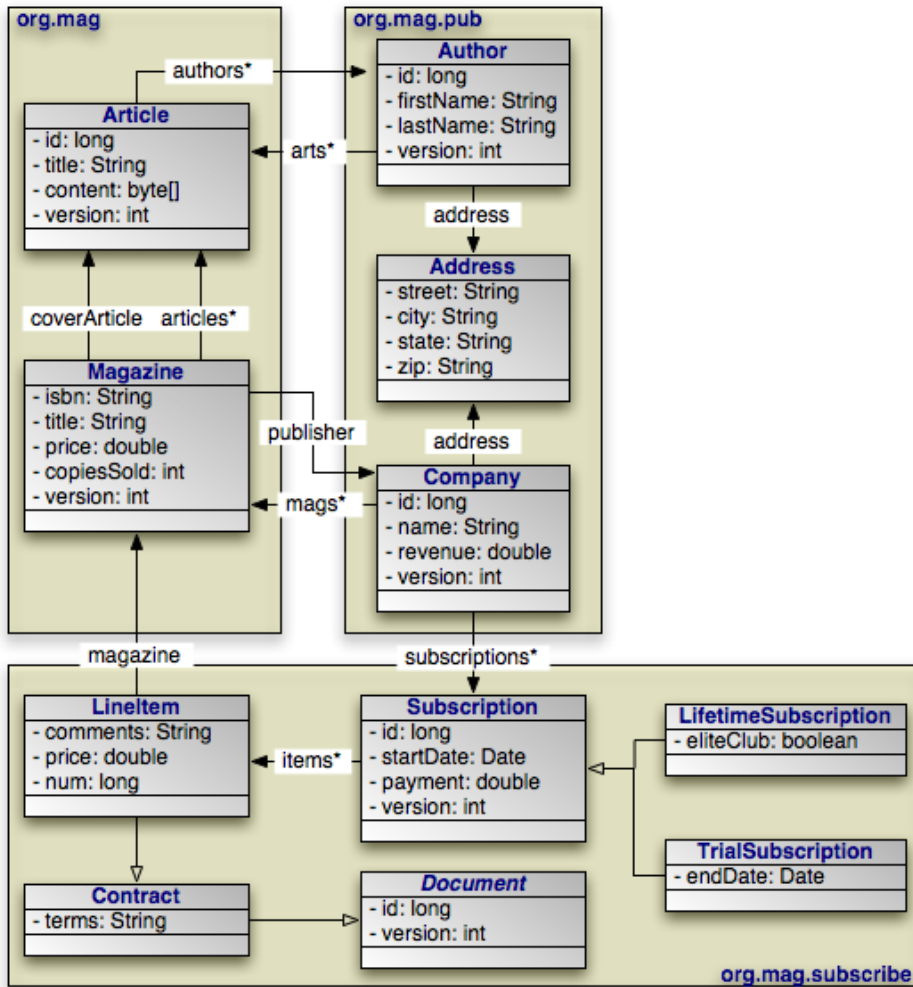

Through the course of this chapter, we will create the persistent object model above.

## 5.1. Class Metadata

The following metadata annotations and XML elements apply to persistent class declarations.

### 5.1.1. Entity

The `Entity` annotation denotes an entity class. All entity classes must have this annotation. The `Entity` annotation takes one optional property:

- `String name`: Name used to refer to the entity in queries. Must not be a reserved literal in JPQL. Defaults to the unqualified name of the entity class.

The equivalent XML element is `entity`. It has the following attributes:

- `class`: The entity class. This attribute is required.
- `name`: Named used to refer to the class in queries. See the name property above.



- **access**: The access type to use for the class. Must either be `FIELD` or `PROPERTY`. For details on access types, see [Section 5.2, “Field and Property Metadata” \[32\]](#).

### Note

OpenJPA uses a process called *enhancement* to modify the bytecode of entities for transparent lazy loading and immediate dirty tracking. See [Section 5.2, “Enhancement” \[274\]](#) in the Reference Guide for details on enhancement.

## 5.1.2. Id Class

As we discussed in [Section 4.2.1, “Identity Class” \[21\]](#), entities with multiple identity fields must use an *identity class* to encapsulate their persistent identity. The `IdClass` annotation specifies this class. It accepts a single `java.lang.Class` value.

The equivalent XML element is `id-class`, which has a single attribute:

- **class**: Set this required attribute to the name of the identity class.

## 5.1.3. Mapped Superclass

A *mapped superclass* is a non-entity class that can define persistent state and mapping information for entity subclasses. Mapped superclasses are usually abstract. Unlike true entities, you cannot query a mapped superclass, pass a mapped superclass instance to any `EntityManager` or `Query` methods, or declare a persistent relation with a mapped superclass target. You denote a mapped superclass with the `MappedSuperclass` marker annotation.

The equivalent XML element is `mapped-superclass`. It expects the following attributes:

- **class**: The entity class. This attribute is required.
- **access**: The access type to use for the class. Must either be `FIELD` or `PROPERTY`. For details on access types, see [Section 5.2, “Field and Property Metadata” \[32\]](#).

### Note

OpenJPA allows you to query on mapped superclasses. A query on a mapped superclass will return all matching subclass instances. OpenJPA also allows you to declare relations to mapped superclass types; however, you cannot query across these relations.

## 5.1.4. Embeddable

The `Embeddable` annotation designates an embeddable persistent class. `Embeddable` instances are stored as part of the record of their owning instance. All embeddable classes must have this annotation.

A persistent class can either be an entity or an embeddable class, but not both.

The equivalent XML element is `embeddable`. It understands the following attributes:

- **class**: The entity class. This attribute is required.
- **access**: The access type to use for the class. Must either be `FIELD` or `PROPERTY`. For details on access types, see [Section 5.2, “Field and Property Metadata” \[32\]](#).

## Note

OpenJPA allows a persistent class to be both an entity and an embeddable class. Instances of the class will act as entities when persisted explicitly or assigned to non-embedded fields of entities. Instances will act as embedded values when assigned to embedded fields of entities.

To signal that a class is both an entity and an embeddable class in OpenJPA, simply add both the `@Entity` and the `@Embeddable` annotations to the class.

### 5.1.5. EntityListeners

An entity may list its lifecycle event listeners in the `EntityListeners` annotation. This value of this annotation is an array of the listener `Classes` for the entity. The equivalent XML element is `entity-listeners`. For more details on entity listeners, see [Section 4.3, “Lifecycle Callbacks” \[23\]](#).

### 5.1.6. Example

Here are the class declarations for our persistent object model, annotated with the appropriate persistence metadata. Note that `Magazine` declares an identity class, and that `Document` and `Address` are a mapped superclass and an embeddable class, respectively. `LifetimeSubscription` and `TrialSubscription` override the default entity name to supply a shorter alias for use in queries.

#### *Example 5.1. Class Metadata*

```
package org.mag;

@Entity
@IdClass(Magazine.MagazineId.class)
public class Magazine {
    ...

    public static class MagazineId {
        ...
    }
}

@Entity
public class Article {
    ...
}

package org.mag.pub;

@Entity
public class Company {
    ...
}

@Entity
public class Author {
    ...
}

@Embeddable
public class Address {
    ...
}

package org.mag.subscribe;

@MappedSuperclass
```

```

public abstract class Document {
    ...
}

@Entity
public class Contract
    extends Document {
    ...
}

@Entity
public class Subscription {
    ...

    @Entity
    public static class LineItem
        extends Contract {
        ...
    }
}

@Entity(name="Lifetime")
public class LifetimeSubscription
    extends Subscription {
    ...
}

@Entity(name="Trial")
public class TrialSubscription
    extends Subscription {
    ...
}

```

The equivalent declarations in XML:

```

<entity-mappings xmlns="http://java.sun.com/xml/ns/persistence/orm"
    xmlns:xsi="http://www.w3.org/2001/XMLSchema-instance"
    xsi:schemaLocation="http://java.sun.com/xml/ns/persistence/orm orm_1_0.xsd"
    version="1.0">
    <mapped-superclass class="org.mag.subscribe.Document">
        ...
    </mapped-superclass>
    <entity class="org.mag.Magazine">
        <id-class class="org.mag.Magazine$MagazineId"/>
        ...
    </entity>
    <entity class="org.mag.Article">
        ...
    </entity>
    <entity class="org.mag.pub.Company">
        ...
    </entity>
    <entity class="org.mag.pub.Author">
        ...
    </entity>
    <entity class="org.mag.subscribe.Contract">
        ...
    </entity>
    <entity class="org.mag.subscribe.LineItem">
        ...
    </entity>
    <entity class="org.mag.subscribe.LifetimeSubscription" name="Lifetime">
        ...
    </entity>
    <entity class="org.mag.subscribe.TrialSubscription" name="Trial">
        ...
    </entity>
    <embeddable class="org.mag.pub.Address">
        ...
    </embeddable>
</entity-mappings>

```

## 5.2. Field and Property Metadata

The persistence implementation must be able to retrieve and set the persistent state of your entities, mapped superclasses, and embeddable types. JPA offers two modes of persistent state access: *field access*, and *property access*. The access type of a persistent attribute can be either set explicitly on a class or attribute level, inherited, or determined by the provider.

Under field access, the implementation injects state directly into your persistent fields, and retrieves changed state from your fields as well. To declare field access on an entire entity with XML metadata, set the `access` attribute of your `entity` XML element to `FIELD`. To use field access for an entire entity using annotation metadata, simply place your metadata and mapping annotations on your field declarations:

```
@ManyToOne
private Company publisher;
```

Property access, on the other hand, retrieves and loads state through JavaBean "getter" and "setter" methods. For a property `p` of type `T`, you must define the following getter method:

```
T getP();
```

For boolean properties, this is also acceptable:

```
boolean isP();
```

You must also define the following setter method:

```
void setP(T value);
```

To implicitly use property access for an entire class by default, set your `entity` element's `access` attribute to `PROPERTY`, or place your metadata and mapping annotations on the getter method:

```
@ManyToOne
private Company getPublisher() { ... }

private void setPublisher(Company publisher) { ... }
```

### 5.2.1. Explicit Access

The access type of a class or individual persistent attributes can be specified explicitly using the `@Access` annotation or `access` attribute on the XML elements used to define persistent attributes. When explicitly defining access, specify the explicit access type for the class and then apply the `@Access` annotation or `access` XML attribute to individual fields or properties. If explicit `FIELD` or `PROPERTY` is specified at the class level, all eligible non-transient fields or properties will

be persistent. If using class level `FIELD` access, non-persistent fields must be `transient` or annotated with `@Transient`. If using class level `PROPERTY` access, non-persistent properties must be annotated `@Transient` or excluded using the `transient` XML attribute. Refer to the JPA specification for specific rules regarding the use of explicit access with embeddables and within an inheritance hierarchy.

This entity definitions shows how multiple access types may be specified on an entity:

```
@Entity
@Access(AccessType.FIELD)
public class PaymentContract {

    @Id
    private String id;

    @Temporal(TemporalType.DATE)
    private String contractDate;

    @Transient
    private String terms;

    @Version
    private int version;

    @Lob
    @Access(AccessType.PROPERTY)
    public String getContractTerms() {
        return terms;
    }

    public void setContractTerms(String terms) {
        // Format string before persisting
        this.terms = formatTerms(terms);
    }
    ...
}
```

The equivalent declarations in XML:

```
<entity-mappings xmlns="http://java.sun.com/xml/ns/persistence/orm"
xmlns:xsi="http://www.w3.org/2001/XMLSchema-instance"
xsi:schemaLocation="http://java.sun.com/xml/ns/persistence/orm orm_2_0.xsd"
version="2.0">
<entity class="org.xyz.PaymentContract" access="FIELD">
<attributes>
<id name="id"/>
<basic name="contractTerms" access="PROPERTY">
<lob/>
</basic>
<basic name="contractDate">
<temporal>DATE</temporal>
</basic>
<version name="version"/>
<transient name="terms"/>
</attributes>
</entity>
</entity-mappings>
```

## Warning

When using property access, only the getter and setter method for a property should ever access the underlying persistent field directly. Other methods, including internal business methods in the persistent class, should go through the getter and setter methods when manipulating persistent state.

Also, take care when adding business logic to your getter and setter methods. Consider that they are invoked by the persistence implementation to load and retrieve all persistent state; other side effects might not be desirable.

The remainder of this document uses the term "persistent field" to refer to either a persistent field or a persistent property.

## 5.2.2. Transient

The `Transient` annotation specifies that a field is non-persistent. Use it to exclude fields from management that would otherwise be persistent. `Transient` is a marker annotation only; it has no properties.

The equivalent XML element is `transient`. It has a single attribute:

- `name`: The transient field or property name. This attribute is required.

## 5.2.3. Id

Annotate your simple identity fields with `Id`. This annotation has no properties. We explore entity identity and identity fields in [Section 4.1.3, “Identity Fields” \[18\]](#).

The equivalent XML element is `id`. It has one required attribute:

- `name`: The name of the identity field or property.

## 5.2.4. Generated Value

The previous section showed you how to declare your identity fields with the `Id` annotation. It is often convenient to allow the persistence implementation to assign a unique value to your identity fields automatically. JPA includes the `GeneratedValue` annotation for this purpose. It has the following properties:

- `GenerationType strategy`: Enum value specifying how to auto-generate the field value. The `GenerationType` enum has the following values:
  - `GeneratorType.AUTO`: The default. Assign the field a generated value, leaving the details to the JPA vendor.
  - `GenerationType.IDENTITY`: The database will assign an identity value on insert.
  - `GenerationType.SEQUENCE`: Use a datastore sequence to generate a field value.
  - `GenerationType.TABLE`: Use a sequence table to generate a field value.
- `String generator`: The name of a generator defined in mapping metadata. We show you how to define named generators in [Section 13.5, “Generators” \[154\]](#). If the `GenerationType` is set but this property is unset, the JPA implementation uses appropriate defaults for the selected generation type.

The equivalent XML element is `generated-value`, which includes the following attributes:

- `strategy`: One of `TABLE`, `SEQUENCE`, `IDENTITY`, or `AUTO`, defaulting to `AUTO`.
- `generator`: Equivalent to the generator property listed above.

### Note

OpenJPA allows you to use the `GeneratedValue` annotation on any field, not just identity fields. Before using the `IDENTITY` generation strategy, however, read [Section 5.4.4, “Autoassign / Identity Strategy Caveats” \[282\]](#) in the Reference Guide.

OpenJPA also offers additional generator strategies for non-numeric fields, which you can access by setting `strategy` to `AUTO` (the default), and setting the generator string to:

- `uuid-string`: OpenJPA will generate a 128-bit type 1 UUID unique within the network, represented as a 16-character string. For more information on UUIDs, see the IETF UUID draft specification at: <http://www.ics.uci.edu/~ejw/authoring/uuid-guid/>
- `uuid-hex`: Same as `uuid-string`, but represents the type 1 UUID as a 32-character hexadecimal string.
- `uuid-type4-string`: OpenJPA will generate a 128-bit type 4 pseudo-random UUID, represented as a 16-character string. For more information on UUIDs, see the IETF UUID draft specification at: <http://www.ics.uci.edu/~ejw/authoring/uuid-guid/>
- `uuid-type4-hex`: Same as `uuid-type4-string`, but represents the type 4 UUID as a 32-character hexadecimal string.

These string constants are defined in `org.apache.openjpa.persistence.Generator`.

If the entities are mapped to the same table name but with different schema name within one `PersistenceUnit` intentionally, and the strategy of `GeneratedType.AUTO` is used to generate the ID for each entity, a schema name for each entity must be explicitly declared either through the annotation or the mapping.xml file. Otherwise, the mapping tool only creates the tables for those entities with the schema names under each schema. In addition, there will be only one `OPENJPA_SEQUENCE_TABLE` created for all the entities within the `PersistenceUnit` if the entities are not identified with the schema name. Read [Section 9.6, “Generators” \[344\]](#) and [Section 4.11, “Default Schema” \[266\]](#) in the Reference Guide.

## 5.2.5. Embedded Id

If your entity has multiple identity values, you may declare multiple `@Id` fields, or you may declare a single `@EmbeddedId` field. The type of a field annotated with `EmbeddedId` must be an embeddable entity class. The fields of this embeddable class are considered the identity values of the owning entity. We explore entity identity and identity fields in [Section 4.1.3, “Identity Fields” \[18\]](#).

The `EmbeddedId` annotation has no properties.

The equivalent XML element is `embedded-id`. It has one required attribute:

- `name`: The name of the identity field or property.

## 5.2.6. Version

Use the `Version` annotation to designate a version field. [Section 4.1.4, “Version Field” \[18\]](#) explained the importance of version fields to JPA. This is a marker annotation; it has no properties.

The equivalent XML element is `version`, which has a single attribute:

- `name`: The name of the version field or property. This attribute is required.

## 5.2.7. Basic

`Basic` signifies a standard value persisted as-is to the datastore. You can use the `Basic` annotation on persistent fields of the following types: primitives, primitive wrappers, `java.lang.String`, `byte[]`, `Byte[]`, `char[]`, `Character[]`,

`java.math.BigDecimal`, `java.math.BigInteger`, `java.util.Date`, `java.util.Calendar`, `java.sql.Date`, `java.sql.Timestamp`, `Enums`, and `Serializable` types.

`Basic` declares these properties:

- `FetchType fetch`: Whether to load the field eagerly (`FetchType.EAGER`) or lazily (`FetchType.LAZY`). Defaults to `FetchType.EAGER`.
- `boolean optional`: Whether the datastore allows null values. Defaults to `true`.

The equivalent XML element is `basic`. It has the following attributes:

- `name`: The name of the field or property. This attribute is required.
- `fetch`: One of `EAGER` or `LAZY`.
- `optional`: Boolean indicating whether the field value may be null.

### 5.2.7.1. Fetch Type

Many metadata annotations in JPA have a `fetch` property. This property can take on one of two values: `FetchType.EAGER` or `FetchType.LAZY`. `FetchType.EAGER` means that the field is loaded by the JPA implementation before it returns the persistent object to you. Whenever you retrieve an entity from a query or from the `EntityManager`, you are guaranteed that all of its eager fields are populated with datastore data.

`FetchType.LAZY` is a hint to the JPA runtime that you want to defer loading of the field until you access it. This is called *lazy loading*. Lazy loading is completely transparent; when you attempt to read the field for the first time, the JPA runtime will load the value from the datastore and populate the field automatically. Lazy loading is only a hint and not a directive because some JPA implementations cannot lazy-load certain field types.

With a mix of eager and lazily-loaded fields, you can ensure that commonly-used fields load efficiently, and that other state loads transparently when accessed. As you will see in [Section 7.3, “Persistence Context” \[77\]](#), you can also use eager fetching to ensure that entities have all needed data loaded before they become *detached* at the end of a persistence context.

#### Note

OpenJPA can lazy-load any field type. OpenJPA also allows you to dynamically change which fields are eagerly or lazily loaded at runtime. See [Section 5.7, “Fetch Groups” \[290\]](#) in the Reference Guide for details.

The Reference Guide details OpenJPA's eager fetching behavior in [Section 5.8, “Eager Fetching” \[294\]](#).

### 5.2.8. Embedded

Use the `Embedded` marker annotation on embeddable field types. Embedded fields are mapped as part of the datastore record of the declaring entity. In our sample model, `Author` and `Company` each embed their `Address`, rather than forming a relation to an `Address` as a separate entity.

The equivalent XML element is `embedded`, which expects a single attribute:

- `name`: The name of the field or property. This attribute is required.

### 5.2.9. Many To One



When an entity A references a single entity B, and other As might also reference the same B, we say there is a *many to one* relation from A to B. In our sample model, for example, each magazine has a reference to its publisher. Multiple magazines might have the same publisher. We say, then, that the `Magazine.publisher` field is a many to one relation from magazines to publishers.

JPA indicates many to one relations between entities with the `ManyToOne` annotation. This annotation has the following properties:

- `Class targetEntity`: The class of the related entity type.
- `CascadeType[] cascade`: Array of enum values defining cascade behavior for this field. We explore cascades below. Defaults to an empty array.
- `FetchType fetch`: Whether to load the field eagerly (`FetchType.EAGER`) or lazily (`FetchType.LAZY`). Defaults to `FetchType.EAGER`. See [Section 5.2.7.1, “Fetch Type” \[36\]](#) above for details on fetch types.
- `boolean optional`: Whether the related object must exist. If `false`, this field cannot be null. Defaults to `true`.

The equivalent XML element is `many-to-one`. It accepts the following attributes:

- `name`: The name of the field or property. This attribute is required.
- `target-entity`: The class of the related type.
- `fetch`: One of `EAGER` or `LAZY`.
- `optional`: Boolean indicating whether the field value may be null.

### 5.2.9.1. Cascade Type

We introduce the JPA `EntityManager` in [Chapter 8, \*EntityManager\* \[81\]](#). The `EntityManager` has APIs to persist new entities, remove (delete) existing entities, refresh entity state from the datastore, and merge *detached* entity state back into the persistence context. We explore all of these APIs in detail later in the overview.

When the `EntityManager` is performing the above operations, you can instruct it to automatically cascade the operation to the entities held in a persistent field with the `cascade` property of your metadata annotation. This process is recursive. The `cascade` property accepts an array of `CascadeType` enum values.

- `CascadeType.PERSIST`: When persisting an entity, also persist the entities held in this field. We suggest liberal application of this cascade rule, because if the `EntityManager` finds a field that references a new entity during flush, and the field does not use `CascadeType.PERSIST`, it is an error.
- `CascadeType.REMOVE`: When deleting an entity, also delete the entities held in this field.
- `CascadeType.REFRESH`: When refreshing an entity, also refresh the entities held in this field.
- `CascadeType.MERGE`: When merging entity state, also merge the entities held in this field.

#### Note

OpenJPA offers enhancements to JPA's `CascadeType.REMOVE` functionality, including additional annotations to control how and when dependent fields will be removed. See [Section 6.4.2.1, “Dependent” \[300\]](#) for more details.

`CascadeType` defines one additional value, `CascadeType.ALL`, that acts as a shortcut for all of the values above. The following annotations are equivalent:

```
@ManyToOne(cascade={CascadeType.PERSIST,CascadeType.REMOVE,
    CascadeType.REFRESH,CascadeType.MERGE})
private Company publisher;
```

```
@ManyToOne(cascade=CascadeType.ALL)
private Company publisher;
```

In XML, these enumeration constants are available as child elements of the `cascade` element. The `cascade` element is itself a child of `many-to-one`. The following examples are equivalent:

```
<many-to-one name="publisher">
  <cascade>
    <cascade-persist/>
    <cascade-merge/>
    <cascade-remove/>
    <cascade-refresh/>
  </cascade>
</many-to-one>
```

```
<many-to-one name="publisher">
  <cascade>
    <cascade-all/>
  </cascade>
</many-to-one>
```

## 5.2.10. One To Many

When an entity A references multiple B entities, and no two As reference the same B, we say there is a *one to many* relation from A to B.

One to many relations are the exact inverse of the many to one relations we detailed in the preceding section. In that section, we said that the `Magazine.publisher` field is a many to one relation from magazines to publishers. Now, we see that the `Company.mags` field is the inverse - a one to many relation from publishers to magazines. Each company may publish multiple magazines, but each magazine can have only one publisher.

JPA indicates one to many relations between entities with the `OneToMany` annotation. This annotation has the following properties:

- `Class targetEntity`: The class of the related entity type. This information is usually taken from the parameterized collection or map element type. You must supply it explicitly, however, if your field isn't a parameterized type.
- `String mappedBy`: Names the many to one field in the related entity that maps this bidirectional relation. We explain bidirectional relations below. Leaving this property unset signals that this is a standard unidirectional relation.
- `CascadeType[] cascade`: Array of enum values defining cascade behavior for the collection elements. We explore cascades above in [Section 5.2.9.1, “Cascade Type” \[37\]](#). Defaults to an empty array.

- `FetchType fetch`: Whether to load the field eagerly (`FetchType.EAGER`) or lazily (`FetchType.LAZY`). Defaults to `FetchType.LAZY`. See [Section 5.2.7.1, “Fetch Type” \[36\]](#) above for details on fetch types.

The equivalent XML element is `one-to-many`, which includes the following attributes:

- `name`: The name of the field or property. This attribute is required.
- `target-entity`: The class of the related type.
- `fetch`: One of `EAGER` or `LAZY`.
- `mapped-by`: The name of the field or property that owns the relation. See [Section 5.2, “Field and Property Metadata” \[32\]](#).

You may also nest the `cascade` element within a `one-to-many` element.

### 5.2.10.1. Bidirectional Relations

When two fields are logical inverses of each other, they form a *bidirectional relation*. Our model contains two bidirectional relations: `Magazine.publisher` and `Company.mags` form one bidirectional relation, and `Article.authors` and `Author.articles` form the other. In both cases, there is a clear link between the two fields that form the relationship. A magazine refers to its publisher while the publisher refers to all its published magazines. An article refers to its authors while each author refers to her written articles.

When the two fields of a bidirectional relation share the same datastore mapping, JPA formalizes the connection with the `mappedBy` property. Marking `Company.mags` as `mappedBy Magazine.publisher` means two things:

1. `Company.mags` uses the datastore mapping for `Magazine.publisher`, but inverts it. In fact, it is illegal to specify any additional mapping information when you use the `mappedBy` property. All mapping information is read from the referenced field. We explore mapping in depth in [Chapter 13, Mapping Metadata \[147\]](#).
2. `Magazine.publisher` is the "owner" of the relation. The field that specifies the mapping data is always the owner. This means that changes to the `Magazine.publisher` field are reflected in the datastore, while changes to the `Company.mags` field alone are not. Changes to `Company.mags` may still affect the JPA implementation's cache, however. Thus, it is very important that you keep your object model consistent by properly maintaining both sides of your bidirectional relations at all times.

You should always take advantage of the `mappedBy` property rather than mapping each field of a bidirectional relation independently. Failing to do so may result in the JPA implementation trying to update the database with conflicting data. Be careful to only mark one side of the relation as `mappedBy`, however. One side has to actually do the mapping!

#### Note

You can configure OpenJPA to automatically synchronize both sides of a bidirectional relation, or to perform various actions when it detects inconsistent relations. See [Section 5.5, “Managed Inverses” \[282\]](#) in the Reference Guide for details.

### 5.2.11. One To One

When an entity A references a single entity B, and no other As can reference the same B, we say there is a *one to one* relation between A and B. In our sample model, `Magazine` has a one to one relation to `Article` through the `Magazine.coverArticle` field. No two magazines can have the same cover article.

JPA indicates one to one relations between entities with the `OneToOne` annotation. This annotation has the following properties:

- `Class targetEntity`: The class of the related entity type. This information is usually taken from the field type.
- `String mappedBy`: Names the field in the related entity that maps this bidirectional relation. We explain bidirectional relations in [Section 5.2.10.1, “Bidirectional Relations” \[39\]](#) above. Leaving this property unset signals that this is a standard unidirectional relation.
- `CascadeType[] cascade`: Array of enum values defining cascade behavior for this field. We explore cascades in [Section 5.2.9.1, “Cascade Type” \[37\]](#) above. Defaults to an empty array.
- `FetchType fetch`: Whether to load the field eagerly (`FetchType.EAGER`) or lazily (`FetchType.LAZY`). Defaults to `FetchType.EAGER`. See [Section 5.2.7.1, “Fetch Type” \[36\]](#) above for details on fetch types.
- `boolean optional`: Whether the related object must exist. If `false`, this field cannot be null. Defaults to `true`.

The equivalent XML element is `one-to-one` which understands the following attributes:

- `name`: The name of the field or property. This attribute is required.
- `target-entity`: The class of the related type.
- `fetch`: One of `EAGER` or `LAZY`.
- `mapped-by`: The field that owns the relation. See [Section 5.2, “Field and Property Metadata” \[32\]](#).

You may also nest the `cascade` element within a `one-to-one` element.

## 5.2.12. Many To Many

When an entity A references multiple B entities, and other As might reference some of the same Bs, we say there is a *many to many* relation between A and B. In our sample model, for example, each article has a reference to all the authors that contributed to the article. Other articles might have some of the same authors. We say, then, that `Article` and `Author` have a many to many relation through the `Article.authors` field.

JPA indicates many to many relations between entities with the `ManyToMany` annotation. This annotation has the following properties:

- `Class targetEntity`: The class of the related entity type. This information is usually taken from the parameterized collection or map element type. You must supply it explicitly, however, if your field isn't a parameterized type.
- `String mappedBy`: Names the many to many field in the related entity that maps this bidirectional relation. We explain bidirectional relations in [Section 5.2.10.1, “Bidirectional Relations” \[39\]](#) above. Leaving this property unset signals that this is a standard unidirectional relation.
- `CascadeType[] cascade`: Array of enum values defining cascade behavior for the collection elements. We explore cascades above in [Section 5.2.9.1, “Cascade Type” \[37\]](#). Defaults to an empty array.
- `FetchType fetch`: Whether to load the field eagerly (`FetchType.EAGER`) or lazily (`FetchType.LAZY`). Defaults to `FetchType.LAZY`. See [Section 5.2.7.1, “Fetch Type” \[36\]](#) above for details on fetch types.

The equivalent XML element is `many-to-many`. It accepts the following attributes:

- `name`: The name of the field or property. This attribute is required.
- `target-entity`: The class of the related type.
- `fetch`: One of `EAGER` or `LAZY`.

- `mapped-by`: The field that owns the relation. See [Section 5.2, “Field and Property Metadata” \[32\]](#).

You may also nest the `cascade` element within a `many-to-many` element.

## 5.2.13. Order By

Datastores such as relational databases do not preserve the order of records. Your persistent `List` fields might be ordered one way the first time you retrieve an object from the datastore, and a completely different way the next. To ensure consistent ordering of collection fields, you must use the `OrderBy` annotation. The `OrderBy` annotation's value is a string defining the order of the collection elements. An empty value means to sort on the identity value(s) of the elements in ascending order. Any other value must be of the form:

```
<field name>[ ASC|DESC][, ...]
```

Each `<field name>` is the name of a persistent field in the collection's element type. You can optionally follow each field by the keyword `ASC` for ascending order, or `DESC` for descending order. If the direction is omitted, it defaults to ascending.

The equivalent XML element is `order-by` which can be listed as a sub-element of the `one-to-many` or `many-to-many` elements. The text within this element is parsed as the order by string.

## 5.2.14. Map Key

JPA supports persistent `Map` fields through either a `OneToMany` or `ManyToMany` association. The related entities form the map values. JPA derives the map keys by extracting a field from each entity value. The `MapKey` annotation designates the field that is used as the key. It has the following properties:

- `String name`: The name of a field in the related entity class to use as the map key. If no name is given, defaults to the identity field of the related entity class.

The equivalent XML element is `map-key` which can be listed as a sub-element of the `one-to-many` or `many-to-many` elements. The `map-key` element has the following attributes:

- `name`: The name of the field in the related entity class to use as the map key.

## 5.2.15. Persistent Field Defaults

In the absence of any of the annotations above, JPA defines the following default behavior for declared fields:

1. Fields declared `static`, `transient`, or `final` default to non-persistent.
2. Fields of any primitive type, primitive wrapper type, `java.lang.String`, `byte[]`, `Byte[]`, `char[]`, `Character[]`, `java.math.BigDecimal`, `java.math.BigInteger`, `java.util.Date`, `java.util.Calendar`, `java.sql.Date`, `java.sql.Timestamp`, or any `Serializable` type default to persistent, as if annotated with `@Basic`.
3. Fields of an embeddable type default to persistent, as if annotated with `@Embedded`.
4. All other fields default to non-persistent.

Note that according to these defaults, all relations between entities must be annotated explicitly. Without an annotation, a relation field will default to serialized storage if the related entity type is serializable, or will default to being non-persistent if not.

## 5.3. XML Schema

The latest revision of the version 2.0 orm schema is presented below. Version 2.0 of the schema must be used if JPA 2.0 elements are specified as XML metadata. Many of the elements in the schema relate to object/relational mapping rather than metadata; these elements are discussed in [Chapter 13, \*Mapping Metadata\* \[147\]](#). Version 1.0 of the orm schema can be found at [http://java.sun.com/xml/ns/persistence/orm\\_1\\_0.xsd](http://java.sun.com/xml/ns/persistence/orm_1_0.xsd).

```
<?xml version="1.0" encoding="UTF-8"?>
  <!-- Java Persistence API object/relational mapping file schema -->
<xsd:schema targetNamespace="http://java.sun.com/xml/ns/persistence/orm"
  xmlns:orm="http://java.sun.com/xml/ns/persistence/orm"
  xmlns:xsd="http://www.w3.org/2001/XMLSchema"
  elementFormDefault="qualified" attributeFormDefault="unqualified"
  version="2.0">

  <xsd:annotation>
    <xsd:documentation>
      @(#)orm_2_0.xsd 2.0 October 1 2009
    </xsd:documentation>
  </xsd:annotation>

<xsd:annotation>
<xsd:documentation>

  DO NOT ALTER OR REMOVE COPYRIGHT NOTICES OR THIS HEADER.

  Copyright 2005-2009 Sun Microsystems, Inc. All rights reserved.

  The contents of this file are subject to the terms of either the
  GNU General Public License Version 2 only ("GPL") or the Common
  Development and Distribution License("CDDL") (collectively, the
  "License"). You may not use this file except in compliance with
  the License. You can obtain a copy of the License at
  https://glassfish.dev.java.net/public/CDDL+GPL.html or
  glassfish/bootstrap/legal/LICENSE.txt. See the License for the
  specific language governing permissions and limitations under the
  License.

  When distributing the software, include this License Header
  Notice in each file and include the License file at
  glassfish/bootstrap/legal/LICENSE.txt. Sun designates this
  particular file as subject to the "Classpath" exception as
  provided by Sun in the GPL Version 2 section of the License file
  that accompanied this code. If applicable, add the following
  below the License Header, with the fields enclosed by brackets []
  replaced by your own identifying information:
  "Portions Copyrighted [year] [name of copyright owner]"

  Contributor(s):

  If you wish your version of this file to be governed by only the
  CDDL or only the GPL Version 2, indicate your decision by adding
  "[Contributor] elects to include this software in this
  distribution under the [CDDL or GPL Version 2] license." If you
  don't indicate a single choice of license, a recipient has the
  option to distribute your version of this file under either the
  CDDL, the GPL Version 2 or to extend the choice of license to its
  licensees as provided above. However, if you add GPL Version 2
  code and therefore, elected the GPL Version 2 license, then the
  option applies only if the new code is made subject to such
  option by the copyright holder.

  </xsd:documentation>
</xsd:annotation>

<xsd:annotation>
<xsd:documentation>
  <![CDATA[
    This is the XML Schema for the persistence object/relational
    mapping file.
    The file may be named "META-INF/orm.xml" in the persistence
```

```

archive or it may be named some other name which would be
used to locate the file as resource on the classpath.
Object/relational mapping files must indicate the object/relational
mapping file schema by using the persistence namespace:
http://java.sun.com/xml/ns/persistence
and indicate the version of the schema by
using the version element as shown below:
<entity-mappings xmlns="http://java.sun.com/xml/ns/persistence/orm"
xmlns:xsi="http://www.w3.org/2001/XMLSchema-instance"
xsi:schemaLocation="http://java.sun.com/xml/ns/persistence/orm
http://java.sun.com/xml/ns/persistence/orm/orm_2_0.xsd"
version="2.0">
...
</entity-mappings>
]]>
</xsd:documentation>
</xsd:annotation>

<xsd:complexType name="emptyType" />
<xsd:simpleType name="versionType">
  <xsd:restriction base="xsd:token">
    <xsd:pattern value="[0-9]+(\.[0-9]+)*" />
  </xsd:restriction>
</xsd:simpleType>
<!-- ***** -->
<xsd:element name="entity-mappings">
  <xsd:complexType>
    <xsd:annotation>
      <xsd:documentation>
        The entity-mappings element is the root element of a mapping
        file. It contains the following four types of elements:
        1. The persistence-unit-metadata element contains metadata
        for the entire persistence unit. It is undefined if this element
        occurs in multiple mapping files within the same
        persistence unit.
        2. The package, schema, catalog and access elements apply to all of
        the entity, mapped-superclass and embeddable
        elements defined in
        the same file in which they occur.
        3. The sequence-generator, table-generator, named-query,
        named-native-query and sql-result-set-mapping
        elements are global
        to the persistence unit. It is undefined to have more than one
        sequence-generator or table-generator of the same
        name in the same
        or different mapping files in a persistence unit. It is also
        undefined to have more than one named-query,
        named-native-query, or
        result-set-mapping of the same name in the same or different mapping
        files in a persistence unit.
        4. The entity, mapped-superclass and embeddable elements each define
        the mapping information for a managed persistent
        class. The mapping
        information contained in these elements may be complete or it may
        be partial.
      </xsd:documentation>
    </xsd:annotation>
  </xsd:complexType>
</xsd:annotation>
<xsd:sequence>
  <xsd:element name="description" type="xsd:string"
    minOccurs="0" />
  <xsd:element name="persistence-unit-metadata"
    type="orm:persistence-unit-metadata" minOccurs="0" />
  <xsd:element name="package" type="xsd:string"
    minOccurs="0" />
  <xsd:element name="schema" type="xsd:string"
    minOccurs="0" />
  <xsd:element name="catalog" type="xsd:string"
    minOccurs="0" />
  <xsd:element name="access" type="orm:access-type"
    minOccurs="0" />
  <xsd:element name="sequence-generator" type="orm:sequence-generator"
    minOccurs="0" maxOccurs="unbounded" />
  <xsd:element name="table-generator" type="orm:table-generator"
    minOccurs="0" maxOccurs="unbounded" />
  <xsd:element name="named-query" type="orm:named-query"
    minOccurs="0" maxOccurs="unbounded" />
  <xsd:element name="named-native-query" type="orm:named-native-query"
    minOccurs="0" maxOccurs="unbounded" />

```

```

        <xsd:element name="sql-result-set-mapping"
            type="orm:sql-result-set-mapping" minOccurs="0"
            maxOccurs="unbounded" />
        <xsd:element name="mapped-superclass" type="orm:mapped-superclass"
            minOccurs="0" maxOccurs="unbounded" />
        <xsd:element name="entity" type="orm:entity"
            minOccurs="0" maxOccurs="unbounded" />
        <xsd:element name="embeddable" type="orm:embeddable"
            minOccurs="0" maxOccurs="unbounded" />
    </xsd:sequence>
    <xsd:attribute name="version" type="orm:versionType"
        fixed="2.0" use="required" />
</xsd:complexType>
</xsd:element>
<!-- ***** -->
<xsd:complexType name="persistence-unit-metadata">
    <xsd:annotation>
        <xsd:documentation>
            Metadata that applies to the persistence unit and not just to
            the mapping file in which it is contained.
            If the xml-mapping-metadata-complete element is specified,
            the complete set of mapping metadata for the persistence unit
            is contained in the XML mapping files for the persistence unit.
        </xsd:documentation>
    </xsd:annotation>
    <xsd:sequence>
        <xsd:element name="description" type="xsd:string"
            minOccurs="0" />
        <xsd:element name="xml-mapping-metadata-complete"
            type="orm:emptyType" minOccurs="0" />
        <xsd:element name="persistence-unit-defaults"
            type="orm:persistence-unit-defaults" minOccurs="0" />
    </xsd:sequence>
</xsd:complexType>
<!-- ***** -->
<xsd:complexType name="persistence-unit-defaults">
    <xsd:annotation>
        <xsd:documentation>
            These defaults are applied to the persistence unit as a whole
            unless they are overridden by local annotation or XML
            element settings.
            schema - Used as the schema for all tables, secondary tables, join
            tables, collection tables, sequence generators, and table
            generators that apply to the persistence unit
            catalog - Used as the catalog for all tables, secondary tables, join
            tables, collection tables, sequence generators, and
            table generators that apply to the persistence unit
            delimited-identifiers - Used to treat database identifiers as
            delimited identifiers.
            access - Used as the access type for all managed classes in
            the persistence unit
            cascade-persist - Adds cascade-persist to the set of cascade options
            in all entity relationships of the persistence unit
            entity-listeners - List of default entity listeners to be invoked
            on each entity in the persistence unit.
        </xsd:documentation>
    </xsd:annotation>
    <xsd:sequence>
        <xsd:element name="description" type="xsd:string"
            minOccurs="0" />
        <xsd:element name="schema" type="xsd:string"
            minOccurs="0" />
        <xsd:element name="catalog" type="xsd:string"
            minOccurs="0" />
        <xsd:element name="delimited-identifiers" type="orm:emptyType"
            minOccurs="0" />
        <xsd:element name="access" type="orm:access-type"
            minOccurs="0" />
        <xsd:element name="cascade-persist" type="orm:emptyType"
            minOccurs="0" />
        <xsd:element name="entity-listeners" type="orm:entity-listeners"
            minOccurs="0" />
    </xsd:sequence>
</xsd:complexType>
<!-- ***** -->
<xsd:complexType name="entity">
    <xsd:annotation>
        <xsd:documentation>

```



```

        Defines the settings and mappings for an entity. Is allowed to be
        sparsely populated and used in conjunction with the annotations.
        Alternatively, the metadata-complete attribute can be
        used to
        indicate that no annotations on the entity class (and its fields
        or properties) are to be processed. If this is the case then
        the defaulting rules for the entity and its subelements will
        be recursively applied.
        @Target(TYPE) @Retention(RUNTIME)
        public @interface Entity {
            String name() default "";
        }
    </xsd:documentation>
</xsd:annotation>
<xsd:sequence>
    <xsd:element name="description" type="xsd:string"
        minOccurs="0" />
    <xsd:element name="table" type="orm:table"
        minOccurs="0" />
    <xsd:element name="secondary-table" type="orm:secondary-table"
        minOccurs="0" maxOccurs="unbounded" />
    <xsd:element name="primary-key-join-column"
        type="orm:primary-key-join-column" minOccurs="0"
        maxOccurs="unbounded" />
    <xsd:element name="id-class" type="orm:id-class"
        minOccurs="0" />
    <xsd:element name="inheritance" type="orm:inheritance"
        minOccurs="0" />
    <xsd:element name="discriminator-value" type="orm:discriminator-value"
        minOccurs="0" />
    <xsd:element name="discriminator-column" type="orm:discriminator-column"
        minOccurs="0" />
    <xsd:element name="sequence-generator" type="orm:sequence-generator"
        minOccurs="0" />
    <xsd:element name="table-generator" type="orm:table-generator"
        minOccurs="0" />
    <xsd:element name="named-query" type="orm:named-query"
        minOccurs="0" maxOccurs="unbounded" />
    <xsd:element name="named-native-query" type="orm:named-native-query"
        minOccurs="0" maxOccurs="unbounded" />
    <xsd:element name="sql-result-set-mapping" type="orm:sql-result-set-mapping"
        minOccurs="0" maxOccurs="unbounded" />
    <xsd:element name="exclude-default-listeners"
        type="orm:emptyType" minOccurs="0" />
    <xsd:element name="exclude-superclass-listeners"
        type="orm:emptyType" minOccurs="0" />
    <xsd:element name="entity-listeners" type="orm:entity-listeners"
        minOccurs="0" />
    <xsd:element name="pre-persist" type="orm:pre-persist"
        minOccurs="0" />
    <xsd:element name="post-persist" type="orm:post-persist"
        minOccurs="0" />
    <xsd:element name="pre-remove" type="orm:pre-remove"
        minOccurs="0" />
    <xsd:element name="post-remove" type="orm:post-remove"
        minOccurs="0" />
    <xsd:element name="pre-update" type="orm:pre-update"
        minOccurs="0" />
    <xsd:element name="post-update" type="orm:post-update"
        minOccurs="0" />
    <xsd:element name="post-load" type="orm:post-load"
        minOccurs="0" />
    <xsd:element name="attribute-override" type="orm:attribute-override"
        minOccurs="0" maxOccurs="unbounded" />
    <xsd:element name="association-override" type="orm:association-override"
        minOccurs="0" maxOccurs="unbounded" />
    <xsd:element name="attributes" type="orm:attributes"
        minOccurs="0" />
</xsd:sequence>
<xsd:attribute name="name" type="xsd:string" />
<xsd:attribute name="class" type="xsd:string" use="required" />
<xsd:attribute name="access" type="orm:access-type" />
<xsd:attribute name="cacheable" type="xsd:boolean" />
<xsd:attribute name="metadata-complete" type="xsd:boolean" />
</xsd:complexType>
<!-- ***** -->
<xsd:simpleType name="access-type">
</xsd:annotation>

```

```

    <xsd:documentation>
      This element determines how the persistence provider accesses the
      state of an entity or embedded object.
    </xsd:documentation>
  </xsd:annotation>
  <xsd:restriction base="xsd:token">
    <xsd:enumeration value="PROPERTY" />
    <xsd:enumeration value="FIELD" />
  </xsd:restriction>
</xsd:simpleType>
<!-- ***** -->
<xsd:complexType name="association-override">
  <xsd:annotation>
    <xsd:documentation>
      @Target({TYPE, METHOD, FIELD}) @Retention(RUNTIME)
      public @interface AssociationOverride {
        String name();
        JoinColumn[] joinColumns() default{};
        JoinTable joinTable() default @JoinTable;
      }
    </xsd:documentation>
  </xsd:annotation>
  <xsd:sequence>
    <xsd:element name="description" type="xsd:string" minOccurs="0" />
    <xsd:choice>
      <xsd:element name="join-column" type="orm:join-column"
        minOccurs="0" maxOccurs="unbounded" />
      <xsd:element name="join-table" type="orm:join-table"
        minOccurs="0" />
    </xsd:choice>
  </xsd:sequence>
  <xsd:attribute name="name" type="xsd:string" use="required" />
</xsd:complexType>
<!-- ***** -->
<xsd:complexType name="attribute-override">
  <xsd:annotation>
    <xsd:documentation>
      @Target({TYPE, METHOD, FIELD}) @Retention(RUNTIME)
      public @interface AttributeOverride {
        String name();
        Column column();
      }
    </xsd:documentation>
  </xsd:annotation>
  <xsd:sequence>
    <xsd:element name="description" type="xsd:string"
      minOccurs="0" />
    <xsd:element name="column" type="orm:column" />
  </xsd:sequence>
  <xsd:attribute name="name" type="xsd:string" use="required" />
</xsd:complexType>
<!-- ***** -->
<xsd:complexType name="attributes">
  <xsd:annotation>
    <xsd:documentation>
      This element contains the entity field or property mappings.
      It may be sparsely populated to include only a subset of the
      fields or properties. If metadata-complete for the entity is true
      then the remainder of the attributes will be defaulted according
      to the default rules.
    </xsd:documentation>
  </xsd:annotation>
  <xsd:sequence>
    <xsd:element name="description" type="xsd:string"
      minOccurs="0" />
    <xsd:choice>
      <xsd:element name="id" type="orm:id"
        minOccurs="0" maxOccurs="unbounded" />
      <xsd:element name="embedded-id" type="orm:embedded-id"
        minOccurs="0" />
    </xsd:choice>
    <xsd:element name="basic" type="orm:basic"
      minOccurs="0" maxOccurs="unbounded" />
    <xsd:element name="version" type="orm:version"
      minOccurs="0" maxOccurs="unbounded" />
    <xsd:element name="many-to-one" type="orm:many-to-one"
      minOccurs="0" maxOccurs="unbounded" />
    <xsd:element name="one-to-many" type="orm:one-to-many"

```

```

        minOccurs="0" maxOccurs="unbounded" />
<xsd:element name="one-to-one" type="orm:one-to-one"
  minOccurs="0" maxOccurs="unbounded" />
<xsd:element name="many-to-many" type="orm:many-to-many"
  minOccurs="0" maxOccurs="unbounded" />
<xsd:element name="element-collection" type="orm:element-collection"
  minOccurs="0" maxOccurs="unbounded" />
<xsd:element name="embedded" type="orm:embedded"
  minOccurs="0" maxOccurs="unbounded" />
<xsd:element name="transient" type="orm:transient"
  minOccurs="0" maxOccurs="unbounded" />
</xsd:sequence>
</xsd:complexType>
<!-- ***** -->
<xsd:complexType name="basic">
  <xsd:annotation>
    <xsd:documentation>
      @Target({METHOD, FIELD}) @Retention(RUNTIME)
      public @interface Basic {
        FetchType fetch() default EAGER;
        boolean optional() default true;
      }
    </xsd:documentation>
  </xsd:annotation>
  <xsd:sequence>
    <xsd:element name="column" type="orm:column"
      minOccurs="0" />
    <xsd:choice>
      <xsd:element name="lob" type="orm:lob"
        minOccurs="0" />
      <xsd:element name="temporal" type="orm:temporal"
        minOccurs="0" />
      <xsd:element name="enumerated" type="orm:enumerated"
        minOccurs="0" />
    </xsd:choice>
  </xsd:sequence>
  <xsd:attribute name="name" type="xsd:string" use="required" />
  <xsd:attribute name="fetch" type="orm:fetch-type" />
  <xsd:attribute name="optional" type="xsd:boolean" />
  <xsd:attribute name="access" type="orm:access-type" />
</xsd:complexType>
<!-- ***** -->
<xsd:complexType name="cascade-type">
  <xsd:annotation>
    <xsd:documentation>
      public enum CascadeType { ALL, PERSIST, MERGE, REMOVE, REFRESH,
        DETACH};
    </xsd:documentation>
  </xsd:annotation>
  <xsd:sequence>
    <xsd:element name="cascade-all" type="orm:emptyType"
      minOccurs="0" />
    <xsd:element name="cascade-persist" type="orm:emptyType"
      minOccurs="0" />
    <xsd:element name="cascade-merge" type="orm:emptyType"
      minOccurs="0" />
    <xsd:element name="cascade-remove" type="orm:emptyType"
      minOccurs="0" />
    <xsd:element name="cascade-refresh" type="orm:emptyType"
      minOccurs="0" />
    <xsd:element name="cascade-detach" type="orm:emptyType"
      minOccurs="0" />
  </xsd:sequence>
</xsd:complexType>
<!-- ***** -->
<xsd:complexType name="collection-table">
  <xsd:annotation>
    <xsd:documentation>
      @Target({METHOD, FIELD}) @Retention(RUNTIME)
      public @interface CollectionTable {
        String name() default "";
        String catalog() default "";
        String schema() default "";
        JoinColumn[] joinColumns() default {};
        UniqueConstraint[] uniqueConstraints() default {};
      }
    </xsd:documentation>
  </xsd:annotation>

```

```

<xsd:sequence>
  <xsd:element name="join-column" type="orm:join-column"
    minOccurs="0" maxOccurs="unbounded" />
  <xsd:element name="unique-constraint" type="orm:unique-constraint"
    minOccurs="0" maxOccurs="unbounded" />
</xsd:sequence>
<xsd:attribute name="name" type="xsd:string" />
<xsd:attribute name="catalog" type="xsd:string" />
<xsd:attribute name="schema" type="xsd:string" />
</xsd:complexType>
<!-- ***** -->
<xsd:complexType name="column">
  <xsd:annotation>
    <xsd:documentation>
      @Target({METHOD, FIELD}) @Retention(RUNTIME)
      public @interface Column {
        String name() default "";
        boolean unique() default false;
        boolean nullable() default true;
        boolean insertable() default true;
        boolean updatable() default true;
        String columnDefinition() default "";
        String table() default "";
        int length() default 255;
        int precision() default 0; // decimal precision
        int scale() default 0; // decimal scale
      }
    </xsd:documentation>
  </xsd:annotation>
  <xsd:attribute name="name" type="xsd:string" />
  <xsd:attribute name="unique" type="xsd:boolean" />
  <xsd:attribute name="nullable" type="xsd:boolean" />
  <xsd:attribute name="insertable" type="xsd:boolean" />
  <xsd:attribute name="updatable" type="xsd:boolean" />
  <xsd:attribute name="column-definition" type="xsd:string" />
  <xsd:attribute name="table" type="xsd:string" />
  <xsd:attribute name="length" type="xsd:int" />
  <xsd:attribute name="precision" type="xsd:int" />
  <xsd:attribute name="scale" type="xsd:int" />
</xsd:complexType>
<!-- ***** -->
<xsd:complexType name="column-result">
  <xsd:annotation>
    <xsd:documentation>
      @Target({}) @Retention(RUNTIME)
      public @interface ColumnResult {
        String name();
      }
    </xsd:documentation>
  </xsd:annotation>
  <xsd:attribute name="name" type="xsd:string" use="required" />
</xsd:complexType>
<!-- ***** -->
<xsd:complexType name="discriminator-column">
  <xsd:annotation>
    <xsd:documentation>
      @Target({TYPE}) @Retention(RUNTIME)
      public @interface DiscriminatorColumn {
        String name() default "DTYPE";
        DiscriminatorType discriminatorType() default STRING;
        String columnDefinition() default "";
        int length() default 31;
      }
    </xsd:documentation>
  </xsd:annotation>
  <xsd:attribute name="name" type="xsd:string" />
  <xsd:attribute name="discriminator-type" type="orm:discriminator-type" />
  <xsd:attribute name="column-definition" type="xsd:string" />
  <xsd:attribute name="length" type="xsd:int" />
</xsd:complexType>
<!-- ***** -->
<xsd:simpleType name="discriminator-type">
  <xsd:annotation>
    <xsd:documentation>
      public enum DiscriminatorType { STRING, CHAR, INTEGER };
    </xsd:documentation>
  </xsd:annotation>
  <xsd:restriction base="xsd:token">

```

```

        <xsd:enumeration value="STRING" />
        <xsd:enumeration value="CHAR" />
        <xsd:enumeration value="INTEGER" />
    </xsd:restriction>
</xsd:simpleType>
<!-- ***** -->
<xsd:simpleType name="discriminator-value">
    <xsd:annotation>
        <xsd:documentation>
            @Target({TYPE}) @Retention(RUNTIME)
            public @interface DiscriminatorValue {
                String value();
            }
        </xsd:documentation>
    </xsd:annotation>
    <xsd:restriction base="xsd:string" />
</xsd:simpleType>
<!-- ***** -->
<xsd:complexType name="element-collection">
    <xsd:annotation>
        <xsd:documentation>
            @Target({METHOD, FIELD}) @Retention(RUNTIME)
            public @interface ElementCollection {
                Class targetClass() default void.class;
                FetchType fetch() default LAZY;
            }
        </xsd:documentation>
    </xsd:annotation>
    <xsd:sequence>
        <xsd:choice>
            <xsd:element name="order-by" type="orm:order-by"
                minOccurs="0" />
            <xsd:element name="order-column" type="orm:order-column"
                minOccurs="0" />
        </xsd:choice>
        <xsd:choice>
            <xsd:element name="map-key" type="orm:map-key"
                minOccurs="0" />
            <xsd:sequence>
                <xsd:element name="map-key-class" type="orm:map-key-class"
                    minOccurs="0" />
                <xsd:choice>
                    <xsd:element name="map-key-temporal"
                        type="orm:temporal" minOccurs="0" />
                    <xsd:element name="map-key-enumerated"
                        type="orm:enumerated" minOccurs="0" />
                    <xsd:element name="map-key-attribute-override"
                        type="orm:attribute-override" minOccurs="0"
                        maxOccurs="unbounded" />
                </xsd:choice>
                <xsd:choice>
                    <xsd:element name="map-key-column"
                        type="orm:map-key-column" minOccurs="0" />
                    <xsd:element name="map-key-join-column"
                        type="orm:map-key-join-column" minOccurs="0"
                        maxOccurs="unbounded" />
                </xsd:choice>
            </xsd:sequence>
        </xsd:choice>
        <xsd:choice>
            <xsd:sequence>
                <xsd:element name="column" type="orm:column"
                    minOccurs="0" />
                <xsd:choice>
                    <xsd:element name="temporal" type="orm:temporal"
                        minOccurs="0" />
                    <xsd:element name="enumerated" type="orm:enumerated"
                        minOccurs="0" />
                    <xsd:element name="lob" type="orm:lob"
                        minOccurs="0" />
                </xsd:choice>
            </xsd:sequence>
        </xsd:choice>
        <xsd:sequence>
            <xsd:element name="attribute-override"
                type="orm:attribute-override" minOccurs="0"
                maxOccurs="unbounded" />
            <xsd:element name="association-override"
                type="orm:association-override" minOccurs="0"

```

```

                maxOccurs="unbounded" />
            </xsd:sequence>
        </xsd:choice>
        <xsd:element name="collection-table" type="orm:collection-table"
            minOccurs="0" />
    </xsd:sequence>
    <xsd:attribute name="name" type="xsd:string" use="required" />
    <xsd:attribute name="target-class" type="xsd:string" />
    <xsd:attribute name="fetch" type="orm:fetch-type" />
    <xsd:attribute name="access" type="orm:access-type" />
</xsd:complexType>
<!-- ***** -->
<xsd:complexType name="embeddable">
    <xsd:annotation>
        <xsd:documentation>
            Defines the settings and mappings for embeddable objects. Is
            allowed to be sparsely populated and used in conjunction with
            the annotations. Alternatively, the metadata-complete attribute
            can be used to indicate that no annotations are to be processed
            in the class. If this is the case then the defaulting rules will
            be recursively applied.
            @Target({TYPE}) @Retention(RUNTIME)
            public @interface Embeddable {}
        </xsd:documentation>
    </xsd:annotation>
    <xsd:sequence>
        <xsd:element name="description" type="xsd:string"
            minOccurs="0" />
        <xsd:element name="attributes" type="orm:embeddable-attributes"
            minOccurs="0" />
    </xsd:sequence>
    <xsd:attribute name="class" type="xsd:string" use="required" />
    <xsd:attribute name="access" type="orm:access-type" />
    <xsd:attribute name="metadata-complete" type="xsd:boolean" />
</xsd:complexType>
<!-- ***** -->
<xsd:complexType name="embeddable-attributes">
    <xsd:sequence>
        <xsd:element name="basic" type="orm:basic"
            minOccurs="0" maxOccurs="unbounded" />
        <xsd:element name="many-to-one" type="orm:many-to-one"
            minOccurs="0" maxOccurs="unbounded" />
        <xsd:element name="one-to-many" type="orm:one-to-many"
            minOccurs="0" maxOccurs="unbounded" />
        <xsd:element name="one-to-one" type="orm:one-to-one"
            minOccurs="0" maxOccurs="unbounded" />
        <xsd:element name="many-to-many" type="orm:many-to-many"
            minOccurs="0" maxOccurs="unbounded" />
        <xsd:element name="element-collection" type="orm:element-collection"
            minOccurs="0" maxOccurs="unbounded" />
        <xsd:element name="embedded" type="orm:embedded"
            minOccurs="0" maxOccurs="unbounded" />
        <xsd:element name="transient" type="orm:transient"
            minOccurs="0" maxOccurs="unbounded" />
    </xsd:sequence>
</xsd:complexType>
<!-- ***** -->
<xsd:complexType name="embedded">
    <xsd:annotation>
        <xsd:documentation>
            @Target({METHOD, FIELD}) @Retention(RUNTIME)
            public @interface Embedded {}
        </xsd:documentation>
    </xsd:annotation>
    <xsd:sequence>
        <xsd:element name="attribute-override" type="orm:attribute-override"
            minOccurs="0" maxOccurs="unbounded" />
        <xsd:element name="association-override" type="orm:association-override"
            minOccurs="0" maxOccurs="unbounded" />
    </xsd:sequence>
    <xsd:attribute name="name" type="xsd:string" use="required" />
    <xsd:attribute name="access" type="orm:access-type" />
</xsd:complexType>
<!-- ***** -->
<xsd:complexType name="embedded-id">
    <xsd:annotation>
        <xsd:documentation>
            @Target({METHOD, FIELD}) @Retention(RUNTIME)

```

```

        public @interface EmbeddedId {}
    </xsd:documentation>
</xsd:annotation>
<xsd:sequence>
    <xsd:element name="attribute-override" type="orm:attribute-override"
        minOccurs="0" maxOccurs="unbounded" />
</xsd:sequence>
<xsd:attribute name="name" type="xsd:string" use="required" />
<xsd:attribute name="access" type="orm:access-type" />
</xsd:complexType>
<!-- ***** -->
<xsd:complexType name="entity-listener">
    <xsd:annotation>
        <xsd:documentation>
            Defines an entity listener to be invoked at lifecycle events
            for the entities that list this listener.
        </xsd:documentation>
    </xsd:annotation>
    <xsd:sequence>
        <xsd:element name="description" type="xsd:string"
            minOccurs="0" />
        <xsd:element name="pre-persist" type="orm:pre-persist"
            minOccurs="0" />
        <xsd:element name="post-persist" type="orm:post-persist"
            minOccurs="0" />
        <xsd:element name="pre-remove" type="orm:pre-remove"
            minOccurs="0" />
        <xsd:element name="post-remove" type="orm:post-remove"
            minOccurs="0" />
        <xsd:element name="pre-update" type="orm:pre-update"
            minOccurs="0" />
        <xsd:element name="post-update" type="orm:post-update"
            minOccurs="0" />
        <xsd:element name="post-load" type="orm:post-load"
            minOccurs="0" />
    </xsd:sequence>
    <xsd:attribute name="class" type="xsd:string" use="required" />
</xsd:complexType>
<!-- ***** -->
<xsd:complexType name="entity-listeners">
    <xsd:annotation>
        <xsd:documentation>
            @Target({TYPE}) @Retention(RUNTIME)
            public @interface EntityListeners {
                Class[] value();
            }
        </xsd:documentation>
    </xsd:annotation>
    <xsd:sequence>
        <xsd:element name="entity-listener" type="orm:entity-listener"
            minOccurs="0" maxOccurs="unbounded" />
    </xsd:sequence>
</xsd:complexType>
<!-- ***** -->
<xsd:complexType name="entity-result">
    <xsd:annotation>
        <xsd:documentation>
            @Target({}) @Retention(RUNTIME)
            public @interface EntityResult {
                Class entityClass();
                FieldResult[] fields() default {};
                String discriminatorColumn() default "";
            }
        </xsd:documentation>
    </xsd:annotation>
    <xsd:sequence>
        <xsd:element name="field-result" type="orm:field-result"
            minOccurs="0" maxOccurs="unbounded" />
    </xsd:sequence>
    <xsd:attribute name="entity-class" type="xsd:string"
        use="required" />
    <xsd:attribute name="discriminator-column" type="xsd:string" />
</xsd:complexType>
<!-- ***** -->
<xsd:simpleType name="enum-type">
    <xsd:annotation>
        <xsd:documentation>
            public enum EnumType {

```

```

        ORDINAL,
        STRING
    }
    </xsd:documentation>
</xsd:annotation>
<xsd:restriction base="xsd:token">
    <xsd:enumeration value="ORDINAL" />
    <xsd:enumeration value="STRING" />
</xsd:restriction>
</xsd:simpleType>
<!-- ***** -->
<xsd:simpleType name="enumerated">
    <xsd:annotation>
        <xsd:documentation>
            @Target({METHOD, FIELD}) @Retention(RUNTIME)
            public @interface Enumerated {
                EnumType value() default ORDINAL;
            }
        </xsd:documentation>
    </xsd:annotation>
    <xsd:restriction base="orm:enum-type" />
</xsd:simpleType>
<!-- ***** -->
<xsd:simpleType name="fetch-type">
    <xsd:annotation>
        <xsd:documentation>
            public enum FetchType { LAZY, EAGER };
        </xsd:documentation>
    </xsd:annotation>
    <xsd:restriction base="xsd:token">
        <xsd:enumeration value="LAZY" />
        <xsd:enumeration value="EAGER" />
    </xsd:restriction>
</xsd:simpleType>
<!-- ***** -->
<xsd:complexType name="field-result">
    <xsd:annotation>
        <xsd:documentation>
            @Target({}) @Retention(RUNTIME)
            public @interface FieldResult {
                String name();
                String column();
            }
        </xsd:documentation>
    </xsd:annotation>
    <xsd:attribute name="name" type="xsd:string" use="required" />
    <xsd:attribute name="column" type="xsd:string"
        use="required" />
</xsd:complexType>
<!-- ***** -->
<xsd:complexType name="generated-value">
    <xsd:annotation>
        <xsd:documentation>
            @Target({METHOD, FIELD}) @Retention(RUNTIME)
            public @interface GeneratedValue {
                GenerationType strategy() default AUTO;
                String generator() default "";
            }
        </xsd:documentation>
    </xsd:annotation>
    <xsd:attribute name="strategy" type="orm:generation-type" />
    <xsd:attribute name="generator" type="xsd:string" />
</xsd:complexType>
<!-- ***** -->
<xsd:simpleType name="generation-type">
    <xsd:annotation>
        <xsd:documentation>
            public enum GenerationType { TABLE, SEQUENCE, IDENTITY, AUTO };
        </xsd:documentation>
    </xsd:annotation>
    <xsd:restriction base="xsd:token">
        <xsd:enumeration value="TABLE" />
        <xsd:enumeration value="SEQUENCE" />
        <xsd:enumeration value="IDENTITY" />
        <xsd:enumeration value="AUTO" />
    </xsd:restriction>
</xsd:simpleType>
<!-- ***** -->

```



```

<xsd:complexType name="id">
  <xsd:annotation>
    <xsd:documentation>
      @Target({METHOD, FIELD}) @Retention(RUNTIME)
      public @interface Id {}
    </xsd:documentation>
  </xsd:annotation>
  <xsd:sequence>
    <xsd:element name="column" type="orm:column"
      minOccurs="0" />
    <xsd:element name="generated-value" type="orm:generated-value"
      minOccurs="0" />
    <xsd:element name="temporal" type="orm:temporal"
      minOccurs="0" />
    <xsd:element name="table-generator" type="orm:table-generator"
      minOccurs="0" />
    <xsd:element name="sequence-generator" type="orm:sequence-generator"
      minOccurs="0" />
  </xsd:sequence>
  <xsd:attribute name="name" type="xsd:string" use="required" />
  <xsd:attribute name="access" type="orm:access-type" />
</xsd:complexType>
<!-- ***** -->
<xsd:complexType name="id-class">
  <xsd:annotation>
    <xsd:documentation>
      @Target({TYPE}) @Retention(RUNTIME)
      public @interface IdClass {
        Class value();
      }
    </xsd:documentation>
  </xsd:annotation>
  <xsd:attribute name="class" type="xsd:string" use="required" />
</xsd:complexType>
<!-- ***** -->
<xsd:complexType name="inheritance">
  <xsd:annotation>
    <xsd:documentation>
      @Target({TYPE}) @Retention(RUNTIME)
      public @interface Inheritance {
        InheritanceType strategy() default SINGLE_TABLE;
      }
    </xsd:documentation>
  </xsd:annotation>
  <xsd:attribute name="strategy" type="orm:inheritance-type" />
</xsd:complexType>
<!-- ***** -->
<xsd:simpleType name="inheritance-type">
  <xsd:annotation>
    <xsd:documentation>
      public enum InheritanceType
      { SINGLE_TABLE, JOINED, TABLE_PER_CLASS};
    </xsd:documentation>
  </xsd:annotation>
  <xsd:restriction base="xsd:token">
    <xsd:enumeration value="SINGLE_TABLE" />
    <xsd:enumeration value="JOINED" />
    <xsd:enumeration value="TABLE_PER_CLASS" />
  </xsd:restriction>
</xsd:simpleType>
<!-- ***** -->
<xsd:complexType name="join-column">
  <xsd:annotation>
    <xsd:documentation>
      @Target({METHOD, FIELD}) @Retention(RUNTIME)
      public @interface JoinColumn {
        String name() default "";
        String referencedColumnName() default "";
        boolean unique() default false;
        boolean nullable() default true;
        boolean insertable() default true;
        boolean updatable() default true;
        String columnDefinition() default "";
        String table() default "";
      }
    </xsd:documentation>
  </xsd:annotation>
  <xsd:attribute name="name" type="xsd:string" />

```

```

<xsd:attribute name="referenced-column-name" type="xsd:string" />
<xsd:attribute name="unique" type="xsd:boolean" />
<xsd:attribute name="nullable" type="xsd:boolean" />
<xsd:attribute name="insertable" type="xsd:boolean" />
<xsd:attribute name="updatable" type="xsd:boolean" />
<xsd:attribute name="column-definition" type="xsd:string" />
<xsd:attribute name="table" type="xsd:string" />
</xsd:complexType>
<!-- ***** -->
<xsd:complexType name="join-table">
  <xsd:annotation>
    <xsd:documentation>
      @Target({METHOD, FIELD}) @Retention(RUNTIME)
      public @interface JoinTable {
        String name() default "";
        String catalog() default "";
        String schema() default "";
        JoinColumn[] joinColumns() default {};
        JoinColumn[] inverseJoinColumns() default {};
        UniqueConstraint[] uniqueConstraints() default {};
      }
    </xsd:documentation>
  </xsd:annotation>
  <xsd:sequence>
    <xsd:element name="join-column" type="orm:join-column"
      minOccurs="0" maxOccurs="unbounded" />
    <xsd:element name="inverse-join-column" type="orm:join-column"
      minOccurs="0" maxOccurs="unbounded" />
    <xsd:element name="unique-constraint" type="orm:unique-constraint"
      minOccurs="0" maxOccurs="unbounded" />
  </xsd:sequence>
  <xsd:attribute name="name" type="xsd:string" />
  <xsd:attribute name="catalog" type="xsd:string" />
  <xsd:attribute name="schema" type="xsd:string" />
</xsd:complexType>
<!-- ***** -->
<xsd:complexType name="lob">
  <xsd:annotation>
    <xsd:documentation>
      @Target({METHOD, FIELD}) @Retention(RUNTIME)
      public @interface Lob {}
    </xsd:documentation>
  </xsd:annotation>
</xsd:complexType>
<!-- ***** -->
<xsd:simpleType name="lock-mode-type">
  <xsd:annotation>
    <xsd:documentation>
      public enum LockModeType { READ, WRITE, OPTIMISTIC,
        OPTIMISTIC_FORCE_INCREMENT, PESSIMISTIC_READ,
        PESSIMISTIC_WRITE,
        PESSIMISTIC_FORCE_INCREMENT, NONE};
    </xsd:documentation>
  </xsd:annotation>
  <xsd:restriction base="xsd:token">
    <xsd:enumeration value="READ" />
    <xsd:enumeration value="WRITE" />
    <xsd:enumeration value="OPTIMISTIC" />
    <xsd:enumeration value="OPTIMISTIC_FORCE_INCREMENT" />
    <xsd:enumeration value="PESSIMISTIC_READ" />
    <xsd:enumeration value="PESSIMISTIC_WRITE" />
    <xsd:enumeration value="PESSIMISTIC_FORCE_INCREMENT" />
    <xsd:enumeration value="NONE" />
  </xsd:restriction>
</xsd:simpleType>
<!-- ***** -->
<xsd:complexType name="many-to-many">
  <xsd:annotation>
    <xsd:documentation>
      @Target({METHOD, FIELD}) @Retention(RUNTIME)
      public @interface ManyToMany {
        Class targetEntity() default void.class;
        Cascade[] cascade() default {};
        FetchType fetch() default LAZY;
        String mappedBy() default "";
      }
    </xsd:documentation>
  </xsd:annotation>

```

```

<xsd:sequence>
  <xsd:choice>
    <xsd:element name="order-by" type="orm:order-by"
      minOccurs="0" />
    <xsd:element name="order-column" type="orm:order-column"
      minOccurs="0" />
  </xsd:choice>
  <xsd:choice>
    <xsd:element name="map-key" type="orm:map-key"
      minOccurs="0" />
    <xsd:sequence>
      <xsd:element name="map-key-class" type="orm:map-key-class"
        minOccurs="0" />
      <xsd:choice>
        <xsd:element name="map-key-temporal"
          type="orm:temporal" minOccurs="0" />
        <xsd:element name="map-key-enumerated"
          type="orm:enumerated" minOccurs="0" />
        <xsd:element name="map-key-attribute-override"
          type="orm:attribute-override" minOccurs="0"
          maxOccurs="unbounded" />
      </xsd:choice>
      <xsd:choice>
        <xsd:element name="map-key-column"
          type="orm:map-key-column" minOccurs="0" />
        <xsd:element name="map-key-join-column"
          type="orm:map-key-join-column" minOccurs="0"
          maxOccurs="unbounded" />
      </xsd:choice>
    </xsd:sequence>
  </xsd:choice>
  <xsd:element name="join-table" type="orm:join-table"
    minOccurs="0" />
  <xsd:element name="cascade" type="orm:cascade-type"
    minOccurs="0" />
</xsd:sequence>
<xsd:attribute name="name" type="xsd:string" use="required" />
<xsd:attribute name="target-entity" type="xsd:string" />
<xsd:attribute name="fetch" type="orm:fetch-type" />
<xsd:attribute name="access" type="orm:access-type" />
<xsd:attribute name="mapped-by" type="xsd:string" />
</xsd:complexType>
<!-- ***** -->
<xsd:complexType name="many-to-one">
  <xsd:annotation>
    <xsd:documentation>
      @Target({METHOD, FIELD}) @Retention(RUNTIME)
      public @interface ManyToOne {
        Class targetEntity() default void.class;
        CascadeType[] cascade() default {};
        FetchType fetch() default EAGER;
        boolean optional() default true;
      }
    </xsd:documentation>
  </xsd:annotation>
  <xsd:sequence>
    <xsd:choice>
      <xsd:element name="join-column" type="orm:join-column"
        minOccurs="0" maxOccurs="unbounded" />
      <xsd:element name="join-table" type="orm:join-table"
        minOccurs="0" />
    </xsd:choice>
    <xsd:element name="cascade" type="orm:cascade-type"
      minOccurs="0" />
  </xsd:sequence>
  <xsd:attribute name="name" type="xsd:string" use="required" />
  <xsd:attribute name="target-entity" type="xsd:string" />
  <xsd:attribute name="fetch" type="orm:fetch-type" />
  <xsd:attribute name="optional" type="xsd:boolean" />
  <xsd:attribute name="access" type="orm:access-type" />
  <xsd:attribute name="maps-id" type="xsd:string" />
  <xsd:attribute name="id" type="xsd:boolean" />
</xsd:complexType>
<!-- ***** -->
<xsd:complexType name="map-key">
  <xsd:annotation>
    <xsd:documentation>
      @Target({METHOD, FIELD}) @Retention(RUNTIME)

```

```

        public @interface MapKey {
            String name() default "";
        }
    </xsd:documentation>
</xsd:annotation>
<xsd:attribute name="name" type="xsd:string" />
</xsd:complexType>
<!-- ***** -->
<xsd:complexType name="map-key-class">
    <xsd:annotation>
        <xsd:documentation>
            @Target({METHOD, FIELD}) @Retention(RUNTIME)
            public @interface MapKeyClass {
                Class value();
            }
        </xsd:documentation>
    </xsd:annotation>
    <xsd:attribute name="class" type="xsd:string" use="required" />
</xsd:complexType>
<!-- ***** -->
<xsd:complexType name="map-key-column">
    <xsd:annotation>
        <xsd:documentation>
            @Target({METHOD, FIELD}) @Retention(RUNTIME)
            public @interface MapKeyColumn {
                String name() default "";
                boolean unique() default false;
                boolean nullable() default false;
                boolean insertable() default true;
                boolean updatable() default true;
                String columnDefinition() default "";
                String table() default "";
                int length() default 255;
                int precision() default 0; // decimal precision
                int scale() default 0; // decimal scale
            }
        </xsd:documentation>
    </xsd:annotation>
    <xsd:attribute name="name" type="xsd:string" />
    <xsd:attribute name="unique" type="xsd:boolean" />
    <xsd:attribute name="nullable" type="xsd:boolean" />
    <xsd:attribute name="insertable" type="xsd:boolean" />
    <xsd:attribute name="updatable" type="xsd:boolean" />
    <xsd:attribute name="column-definition" type="xsd:string" />
    <xsd:attribute name="table" type="xsd:string" />
    <xsd:attribute name="length" type="xsd:int" />
    <xsd:attribute name="precision" type="xsd:int" />
    <xsd:attribute name="scale" type="xsd:int" />
</xsd:complexType>
<!-- ***** -->
<xsd:complexType name="map-key-join-column">
    <xsd:annotation>
        <xsd:documentation>
            @Target({METHOD, FIELD}) @Retention(RUNTIME)
            public @interface MapKeyJoinColumn {
                String name() default "";
                String referencedColumnName() default "";
                boolean unique() default false;
                boolean nullable() default false;
                boolean insertable() default true;
                boolean updatable() default true;
                String columnDefinition() default "";
                String table() default "";
            }
        </xsd:documentation>
    </xsd:annotation>
    <xsd:attribute name="name" type="xsd:string" />
    <xsd:attribute name="referenced-column-name" type="xsd:string" />
    <xsd:attribute name="unique" type="xsd:boolean" />
    <xsd:attribute name="nullable" type="xsd:boolean" />
    <xsd:attribute name="insertable" type="xsd:boolean" />
    <xsd:attribute name="updatable" type="xsd:boolean" />
    <xsd:attribute name="column-definition" type="xsd:string" />
    <xsd:attribute name="table" type="xsd:string" />
</xsd:complexType>
<!-- ***** -->
<xsd:complexType name="mapped-superclass">
    <xsd:annotation>

```

```

<xsd:documentation>
    Defines the settings and mappings for a mapped superclass. Is
    allowed to be sparsely populated and used in conjunction with
    the annotations. Alternatively, the metadata-complete attribute
    can be used to indicate that no annotations are to be processed
    If this is the case then the defaulting rules will be recursively
    applied.
    @Target(TYPE) @Retention(RUNTIME)
    public @interface MappedSuperclass{}
</xsd:documentation>
</xsd:annotation>
<xsd:sequence>
    <xsd:element name="description" type="xsd:string"
        minOccurs="0" />
    <xsd:element name="id-class" type="orm:id-class"
        minOccurs="0" />
    <xsd:element name="exclude-default-listeners"
        type="orm:emptyType" minOccurs="0" />
    <xsd:element name="exclude-superclass-listeners"
        type="orm:emptyType" minOccurs="0" />
    <xsd:element name="entity-listeners" type="orm:entity-listeners"
        minOccurs="0" />
    <xsd:element name="pre-persist" type="orm:pre-persist"
        minOccurs="0" />
    <xsd:element name="post-persist" type="orm:post-persist"
        minOccurs="0" />
    <xsd:element name="pre-remove" type="orm:pre-remove"
        minOccurs="0" />
    <xsd:element name="post-remove" type="orm:post-remove"
        minOccurs="0" />
    <xsd:element name="pre-update" type="orm:pre-update"
        minOccurs="0" />
    <xsd:element name="post-update" type="orm:post-update"
        minOccurs="0" />
    <xsd:element name="post-load" type="orm:post-load"
        minOccurs="0" />
    <xsd:element name="attributes" type="orm:attributes"
        minOccurs="0" />
</xsd:sequence>
<xsd:attribute name="class" type="xsd:string" use="required" />
<xsd:attribute name="access" type="orm:access-type" />
<xsd:attribute name="metadata-complete" type="xsd:boolean" />
</xsd:complexType>
<!-- ***** -->
<xsd:complexType name="named-native-query">
    <xsd:annotation>
        <xsd:documentation>
            @Target({TYPE}) @Retention(RUNTIME)
            public @interface NamedNativeQuery {
                String name();
                String query();
                QueryHint[] hints() default {};
                Class resultClass() default void.class;
                String resultSetMapping() default ""; //named SqlResultSetMapping
            }
        </xsd:documentation>
    </xsd:annotation>
    <xsd:sequence>
        <xsd:element name="description" type="xsd:string"
            minOccurs="0" />
        <xsd:element name="query" type="xsd:string" />
        <xsd:element name="hint" type="orm:query-hint"
            minOccurs="0" maxOccurs="unbounded" />
    </xsd:sequence>
    <xsd:attribute name="name" type="xsd:string" use="required" />
    <xsd:attribute name="result-class" type="xsd:string" />
    <xsd:attribute name="result-set-mapping" type="xsd:string" />
</xsd:complexType>
<!-- ***** -->
<xsd:complexType name="named-query">
    <xsd:annotation>
        <xsd:documentation>
            @Target({TYPE}) @Retention(RUNTIME)
            public @interface NamedQuery {
                String name();
                String query();
                LockModeType lockMode() default NONE;
                QueryHint[] hints() default {};
            }
        </xsd:documentation>
    </xsd:annotation>
    <xsd:sequence>
        <xsd:element name="description" type="xsd:string"
            minOccurs="0" />
        <xsd:element name="query" type="xsd:string" />
        <xsd:element name="lock-mode" type="orm:lock-mode"
            minOccurs="0" />
        <xsd:element name="hint" type="orm:query-hint"
            minOccurs="0" maxOccurs="unbounded" />
    </xsd:sequence>
    <xsd:attribute name="name" type="xsd:string" use="required" />
    <xsd:attribute name="result-class" type="xsd:string" />
    <xsd:attribute name="result-set-mapping" type="xsd:string" />
    <xsd:attribute name="lock-mode" type="orm:lock-mode" />
</xsd:complexType>

```

```

    }
  </xsd:documentation>
</xsd:annotation>
<xsd:sequence>
  <xsd:element name="description" type="xsd:string"
    minOccurs="0" />
  <xsd:element name="query" type="xsd:string" />
  <xsd:element name="lock-mode" type="orm:lock-mode-type"
    minOccurs="0" />
  <xsd:element name="hint" type="orm:query-hint"
    minOccurs="0" maxOccurs="unbounded" />
</xsd:sequence>
  <xsd:attribute name="name" type="xsd:string" use="required" />
</xsd:complexType>
<!-- ***** -->
<xsd:complexType name="one-to-many">
  <xsd:annotation>
    <xsd:documentation>
      @Target({METHOD, FIELD}) @Retention(RUNTIME)
      public @interface OneToMany {
        Class targetEntity() default void.class;
        CascadeType[] cascade() default {};
        FetchType fetch() default LAZY;
        String mappedBy() default "";
      }
    </xsd:documentation>
  </xsd:annotation>
  <xsd:sequence>
    <xsd:choice>
      <xsd:element name="order-by" type="orm:order-by"
        minOccurs="0" />
      <xsd:element name="order-column" type="orm:order-column"
        minOccurs="0" />
    </xsd:choice>
    <xsd:choice>
      <xsd:element name="map-key" type="orm:map-key"
        minOccurs="0" />
      <xsd:sequence>
        <xsd:element name="map-key-class" type="orm:map-key-class"
          minOccurs="0" />
        <xsd:choice>
          <xsd:element name="map-key-temporal"
            type="orm:temporal" minOccurs="0" />
          <xsd:element name="map-key-enumerated"
            type="orm:enumerated" minOccurs="0" />
          <xsd:element name="map-key-attribute-override"
            type="orm:attribute-override" minOccurs="0"
            maxOccurs="unbounded" />
        </xsd:choice>
        <xsd:choice>
          <xsd:element name="map-key-column"
            type="orm:map-key-column" minOccurs="0" />
          <xsd:element name="map-key-join-column"
            type="orm:map-key-join-column" minOccurs="0"
            maxOccurs="unbounded" />
        </xsd:choice>
      </xsd:sequence>
    </xsd:choice>
    <xsd:choice>
      <xsd:element name="join-table" type="orm:join-table"
        minOccurs="0" />
      <xsd:element name="join-column" type="orm:join-column"
        minOccurs="0" maxOccurs="unbounded" />
    </xsd:choice>
    <xsd:element name="cascade" type="orm:cascade-type"
      minOccurs="0" />
  </xsd:sequence>
  <xsd:attribute name="name" type="xsd:string" use="required" />
  <xsd:attribute name="target-entity" type="xsd:string" />
  <xsd:attribute name="fetch" type="orm:fetch-type" />
  <xsd:attribute name="access" type="orm:access-type" />
  <xsd:attribute name="mapped-by" type="xsd:string" />
  <xsd:attribute name="orphan-removal" type="xsd:boolean" />
</xsd:complexType>
<!-- ***** -->
<xsd:complexType name="one-to-one">
  <xsd:annotation>
    <xsd:documentation>

```

```

        @Target({METHOD, FIELD}) @Retention(RUNTIME)
        public @interface OneToOne {
            Class targetEntity() default void.class;
            CascadeType[] cascade() default {};
            FetchType fetch() default EAGER;
            boolean optional() default true;
            String mappedBy() default "";
            boolean orphanRemoval() default false;
        }
    </xsd:documentation>
</xsd:annotation>
<xsd:sequence>
    <xsd:choice>
        <xsd:element name="primary-key-join-column"
            type="orm:primary-key-join-column" minOccurs="0"
            maxOccurs="unbounded" />
        <xsd:element name="join-column" type="orm:join-column"
            minOccurs="0" maxOccurs="unbounded" />
        <xsd:element name="join-table" type="orm:join-table"
            minOccurs="0" />
    </xsd:choice>
    <xsd:element name="cascade" type="orm:cascade-type"
        minOccurs="0" />
</xsd:sequence>
<xsd:attribute name="name" type="xsd:string" use="required" />
<xsd:attribute name="target-entity" type="xsd:string" />
<xsd:attribute name="fetch" type="orm:fetch-type" />
<xsd:attribute name="optional" type="xsd:boolean" />
<xsd:attribute name="access" type="orm:access-type" />
<xsd:attribute name="mapped-by" type="xsd:string" />
<xsd:attribute name="orphan-removal" type="xsd:boolean" />
<xsd:attribute name="maps-id" type="xsd:string" />
<xsd:attribute name="id" type="xsd:boolean" />
</xsd:complexType>
<!-- ***** -->
<xsd:simpleType name="order-by">
    <xsd:annotation>
        <xsd:documentation>
            @Target({METHOD, FIELD}) @Retention(RUNTIME)
            public @interface OrderBy {
                String value() default "";
            }
        </xsd:documentation>
    </xsd:annotation>
    <xsd:restriction base="xsd:string" />
</xsd:simpleType>
<!-- ***** -->
<xsd:complexType name="order-column">
    <xsd:annotation>
        <xsd:documentation>
            @Target({METHOD, FIELD}) @Retention(RUNTIME)
            public @interface OrderColumn {
                String name() default "";
                boolean nullable() default true;
                boolean insertable() default true;
                boolean updatable() default true;
                String columnDefinition() default "";
            }
        </xsd:documentation>
    </xsd:annotation>
    <xsd:attribute name="name" type="xsd:string" />
    <xsd:attribute name="nullable" type="xsd:boolean" />
    <xsd:attribute name="insertable" type="xsd:boolean" />
    <xsd:attribute name="updatable" type="xsd:boolean" />
    <xsd:attribute name="column-definition" type="xsd:string" />
</xsd:complexType>
<!-- ***** -->
<xsd:complexType name="post-load">
    <xsd:annotation>
        <xsd:documentation>
            @Target({METHOD}) @Retention(RUNTIME)
            public @interface PostLoad {}
        </xsd:documentation>
    </xsd:annotation>
    <xsd:sequence>
        <xsd:element name="description" type="xsd:string"
            minOccurs="0" />
    </xsd:sequence>

```

```

        <xsd:attribute name="method-name" type="xsd:string"
            use="required" />
    </xsd:complexType>
    <!-- ***** -->
    <xsd:complexType name="post-persist">
        <xsd:annotation>
            <xsd:documentation>
                @Target({METHOD}) @Retention(RUNTIME)
                public @interface PostPersist {}
            </xsd:documentation>
        </xsd:annotation>
        <xsd:sequence>
            <xsd:element name="description" type="xsd:string"
                minOccurs="0" />
        </xsd:sequence>
        <xsd:attribute name="method-name" type="xsd:string"
            use="required" />
    </xsd:complexType>
    <!-- ***** -->
    <xsd:complexType name="post-remove">
        <xsd:annotation>
            <xsd:documentation>
                @Target({METHOD}) @Retention(RUNTIME)
                public @interface PostRemove {}
            </xsd:documentation>
        </xsd:annotation>
        <xsd:sequence>
            <xsd:element name="description" type="xsd:string"
                minOccurs="0" />
        </xsd:sequence>
        <xsd:attribute name="method-name" type="xsd:string"
            use="required" />
    </xsd:complexType>
    <!-- ***** -->
    <xsd:complexType name="post-update">
        <xsd:annotation>
            <xsd:documentation>
                @Target({METHOD}) @Retention(RUNTIME)
                public @interface PostUpdate {}
            </xsd:documentation>
        </xsd:annotation>
        <xsd:sequence>
            <xsd:element name="description" type="xsd:string"
                minOccurs="0" />
        </xsd:sequence>
        <xsd:attribute name="method-name" type="xsd:string"
            use="required" />
    </xsd:complexType>
    <!-- ***** -->
    <xsd:complexType name="pre-persist">
        <xsd:annotation>
            <xsd:documentation>
                @Target({METHOD}) @Retention(RUNTIME)
                public @interface PrePersist {}
            </xsd:documentation>
        </xsd:annotation>
        <xsd:sequence>
            <xsd:element name="description" type="xsd:string"
                minOccurs="0" />
        </xsd:sequence>
        <xsd:attribute name="method-name" type="xsd:string"
            use="required" />
    </xsd:complexType>
    <!-- ***** -->
    <xsd:complexType name="pre-remove">
        <xsd:annotation>
            <xsd:documentation>
                @Target({METHOD}) @Retention(RUNTIME)
                public @interface PreRemove {}
            </xsd:documentation>
        </xsd:annotation>
        <xsd:sequence>
            <xsd:element name="description" type="xsd:string"
                minOccurs="0" />
        </xsd:sequence>
        <xsd:attribute name="method-name" type="xsd:string"
            use="required" />
    </xsd:complexType>

```



```

<!-- ***** -->
<xsd:complexType name="pre-update">
  <xsd:annotation>
    <xsd:documentation>
      @Target({METHOD}) @Retention(RUNTIME)
      public @interface PreUpdate {}
    </xsd:documentation>
  </xsd:annotation>
  <xsd:sequence>
    <xsd:element name="description" type="xsd:string"
      minOccurs="0" />
  </xsd:sequence>
  <xsd:attribute name="method-name" type="xsd:string"
    use="required" />
</xsd:complexType>
<!-- ***** -->
<xsd:complexType name="primary-key-join-column">
  <xsd:annotation>
    <xsd:documentation>
      @Target({TYPE, METHOD, FIELD}) @Retention(RUNTIME)
      public @interface PrimaryKeyJoinColumn {
        String name() default "";
        String referencedColumnName() default "";
        String columnDefinition() default "";
      }
    </xsd:documentation>
  </xsd:annotation>
  <xsd:attribute name="name" type="xsd:string" />
  <xsd:attribute name="referenced-column-name" type="xsd:string" />
  <xsd:attribute name="column-definition" type="xsd:string" />
</xsd:complexType>
<!-- ***** -->
<xsd:complexType name="query-hint">
  <xsd:annotation>
    <xsd:documentation>
      @Target({}) @Retention(RUNTIME)
      public @interface QueryHint {
        String name();
        String value();
      }
    </xsd:documentation>
  </xsd:annotation>
  <xsd:sequence>
    <xsd:element name="description" type="xsd:string"
      minOccurs="0" />
  </xsd:sequence>
  <xsd:attribute name="name" type="xsd:string" use="required" />
  <xsd:attribute name="value" type="xsd:string" use="required" />
</xsd:complexType>
<!-- ***** -->
<xsd:complexType name="secondary-table">
  <xsd:annotation>
    <xsd:documentation>
      @Target({TYPE}) @Retention(RUNTIME)
      public @interface SecondaryTable {
        String name();
        String catalog() default "";
        String schema() default "";
        PrimaryKeyJoinColumn[] pkJoinColumns() default {};
        UniqueConstraint[] uniqueConstraints() default {};
      }
    </xsd:documentation>
  </xsd:annotation>
  <xsd:sequence>
    <xsd:element name="primary-key-join-column"
      type="orm:primary-key-join-column" minOccurs="0"
      maxOccurs="unbounded" />
    <xsd:element name="unique-constraint" type="orm:unique-constraint"
      minOccurs="0" maxOccurs="unbounded" />
  </xsd:sequence>
  <xsd:attribute name="name" type="xsd:string" use="required" />
  <xsd:attribute name="catalog" type="xsd:string" />
  <xsd:attribute name="schema" type="xsd:string" />
</xsd:complexType>
<!-- ***** -->
<xsd:complexType name="sequence-generator">
  <xsd:annotation>
    <xsd:documentation>

```

```

        @Target({TYPE, METHOD, FIELD}) @Retention(RUNTIME)
        public @interface SequenceGenerator {
            String name();
            String sequenceName() default "";
            String catalog() default "";
            String schema() default "";
            int initialValue() default 1;
            int allocationSize() default 50;
        }
    </xsd:documentation>
</xsd:annotation>
<xsd:sequence>
    <xsd:element name="description" type="xsd:string"
        minOccurs="0" />
</xsd:sequence>
<xsd:attribute name="name" type="xsd:string" use="required" />
<xsd:attribute name="sequence-name" type="xsd:string" />
<xsd:attribute name="catalog" type="xsd:string" />
<xsd:attribute name="schema" type="xsd:string" />
<xsd:attribute name="initial-value" type="xsd:int" />
<xsd:attribute name="allocation-size" type="xsd:int" />
</xsd:complexType>
<!-- ***** -->
<xsd:complexType name="sql-result-set-mapping">
    <xsd:annotation>
        <xsd:documentation>
            @Target({TYPE}) @Retention(RUNTIME)
            public @interface SqlResultSetMapping {
                String name();
                EntityResult[] entities() default {};
                ColumnResult[] columns() default {};
            }
        </xsd:documentation>
    </xsd:annotation>
    <xsd:sequence>
        <xsd:element name="description" type="xsd:string"
            minOccurs="0" />
        <xsd:element name="entity-result" type="orm:entity-result"
            minOccurs="0" maxOccurs="unbounded" />
        <xsd:element name="column-result" type="orm:column-result"
            minOccurs="0" maxOccurs="unbounded" />
    </xsd:sequence>
    <xsd:attribute name="name" type="xsd:string" use="required" />
</xsd:complexType>
<!-- ***** -->
<xsd:complexType name="table">
    <xsd:annotation>
        <xsd:documentation>
            @Target({TYPE}) @Retention(RUNTIME)
            public @interface Table {
                String name() default "";
                String catalog() default "";
                String schema() default "";
                UniqueConstraint[] uniqueConstraints() default {};
            }
        </xsd:documentation>
    </xsd:annotation>
    <xsd:sequence>
        <xsd:element name="unique-constraint" type="orm:unique-constraint"
            minOccurs="0" maxOccurs="unbounded" />
    </xsd:sequence>
    <xsd:attribute name="name" type="xsd:string" />
    <xsd:attribute name="catalog" type="xsd:string" />
    <xsd:attribute name="schema" type="xsd:string" />
</xsd:complexType>
<!-- ***** -->
<xsd:complexType name="table-generator">
    <xsd:annotation>
        <xsd:documentation>
            @Target({TYPE, METHOD, FIELD}) @Retention(RUNTIME)
            public @interface TableGenerator {
                String name();
                String table() default "";
                String catalog() default "";
                String schema() default "";
                String pkColumnName() default "";
                String valueColumnName() default "";
                String pkColumnValue() default "";
            }
        </xsd:documentation>
    </xsd:annotation>
    <xsd:sequence>
        <xsd:element name="description" type="xsd:string"
            minOccurs="0" />
    </xsd:sequence>
    <xsd:attribute name="name" type="xsd:string" use="required" />
    <xsd:attribute name="table" type="xsd:string" />
    <xsd:attribute name="catalog" type="xsd:string" />
    <xsd:attribute name="schema" type="xsd:string" />
    <xsd:attribute name="pk-column-name" type="xsd:string" />
    <xsd:attribute name="value-column-name" type="xsd:string" />
    <xsd:attribute name="pk-column-value" type="xsd:string" />
</xsd:complexType>

```

```

        int initialValue() default 0;
        int allocationSize() default 50;
        UniqueConstraint[] uniqueConstraints() default {};
    }
</xsd:documentation>
</xsd:annotation>
<xsd:sequence>
  <xsd:element name="description" type="xsd:string"
    minOccurs="0" />
  <xsd:element name="unique-constraint" type="orm:unique-constraint"
    minOccurs="0" maxOccurs="unbounded" />
</xsd:sequence>
<xsd:attribute name="name" type="xsd:string" use="required" />
<xsd:attribute name="table" type="xsd:string" />
<xsd:attribute name="catalog" type="xsd:string" />
<xsd:attribute name="schema" type="xsd:string" />
<xsd:attribute name="pk-column-name" type="xsd:string" />
<xsd:attribute name="value-column-name" type="xsd:string" />
<xsd:attribute name="pk-column-value" type="xsd:string" />
<xsd:attribute name="initial-value" type="xsd:int" />
<xsd:attribute name="allocation-size" type="xsd:int" />
</xsd:complexType>
<!-- ***** -->
<xsd:simpleType name="temporal">
  <xsd:annotation>
    <xsd:documentation>
      @Target({METHOD, FIELD}) @Retention(RUNTIME)
      public @interface Temporal {
        TemporalType value();
      }
    </xsd:documentation>
  </xsd:annotation>
  <xsd:restriction base="orm:temporal-type" />
</xsd:simpleType>
<!-- ***** -->
<xsd:simpleType name="temporal-type">
  <xsd:annotation>
    <xsd:documentation>
      public enum TemporalType {
        DATE, // java.sql.Date
        TIME, // java.sql.Time
        TIMESTAMP // java.sql.Timestamp
      }
    </xsd:documentation>
  </xsd:annotation>
  <xsd:restriction base="xsd:token">
    <xsd:enumeration value="DATE" />
    <xsd:enumeration value="TIME" />
    <xsd:enumeration value="TIMESTAMP" />
  </xsd:restriction>
</xsd:simpleType>
<!-- ***** -->
<xsd:complexType name="transient">
  <xsd:annotation>
    <xsd:documentation>
      @Target({METHOD, FIELD}) @Retention(RUNTIME)
      public @interface Transient {}
    </xsd:documentation>
  </xsd:annotation>
  <xsd:attribute name="name" type="xsd:string" use="required" />
</xsd:complexType>
<!-- ***** -->
<xsd:complexType name="unique-constraint">
  <xsd:annotation>
    <xsd:documentation>
      @Target({}) @Retention(RUNTIME)
      public @interface UniqueConstraint {
        String name() default "";
        String[] columnNames();
      }
    </xsd:documentation>
  </xsd:annotation>
  <xsd:sequence>
    <xsd:element name="column-name" type="xsd:string"
      maxOccurs="unbounded" />
  </xsd:sequence>
  <xsd:attribute name="name" type="xsd:string" />
</xsd:complexType>

```

```

<!-- ***** -->
<xsd:complexType name="version">
  <xsd:annotation>
    <xsd:documentation>
      @Target({METHOD, FIELD}) @Retention(RUNTIME)
      public @interface Version {}
    </xsd:documentation>
  </xsd:annotation>
  <xsd:sequence>
    <xsd:element name="column" type="orm:column"
      minOccurs="0" />
    <xsd:element name="temporal" type="orm:temporal"
      minOccurs="0" />
  </xsd:sequence>
  <xsd:attribute name="name" type="xsd:string" use="required" />
  <xsd:attribute name="access" type="orm:access-type" />
</xsd:complexType>
</xsd:schema>

```

## 5.4. Conclusion

That exhausts persistence metadata annotations. We present the class definitions for our sample model below:

### *Example 5.2. Complete Metadata*

```

package org.mag;

@Entity
@IdClass(Magazine.MagazineId.class)
public class Magazine {

    @Id private String isbn;
    @Id private String title;
    @Version private int version;

    private double price; // defaults to @Basic
    private int copiesSold; // defaults to @Basic

    @OneToOne(fetch=FetchType.LAZY,
      cascade={CascadeType.PERSIST,CascadeType.REMOVE})
    private Article coverArticle;

    @OneToMany(cascade={CascadeType.PERSIST,CascadeType.REMOVE})
    @OrderBy
    private Collection<Article> articles;

    @ManyToOne(fetch=FetchType.LAZY, cascade=CascadeType.PERSIST)
    private Company publisher;

    @Transient private byte[] data;

    ...

    public static class MagazineId {
        ...
    }
}

@Entity
public class Article {

    @Id private long id;
    @Version private int version;

    private String title; // defaults to @Basic
    private byte[] content; // defaults to @Basic

    @ManyToMany(cascade=CascadeType.PERSIST)
    @OrderBy("lastName, firstName")
    private Collection<Author> authors;

```

```
    ...
}

package org.mag.pub;

@Entity
public class Company {

    @Id private long id;
    @Version private int version;

    private String name; // defaults to @Basic
    private double revenue; // defaults to @Basic
    private Address address; // defaults to @Embedded

    @OneToMany(mappedBy="publisher", cascade=CascadeType.PERSIST)
    private Collection<Magazine> mags;

    @OneToMany(cascade={CascadeType.PERSIST,CascadeType.REMOVE})
    private Collection<Subscription> subscriptions;

    ...
}

@Entity
public class Author {

    @Id private long id;
    @Version private int version;

    private String firstName; // defaults to @Basic
    private double lastName; // defaults to @Basic
    private Address address; // defaults to @Embedded

    @ManyToMany(mappedBy="authors", cascade=CascadeType.PERSIST)
    private Collection<Article> arts;

    ...
}

@Embeddable
public class Address {

    private String street; // defaults to @Basic
    private String city; // defaults to @Basic
    private String state; // defaults to @Basic
    private String zip; // defaults to @Basic

    ...
}

package org.mag.subscribe;

@MappedSuperclass
public abstract class Document {

    @Id private long id;
    @Version private int version;

    ...
}

@Entity
public class Contract
    extends Document {

    private String terms; // defaults to @Basic

    ...
}

@Entity
public class Subscription {

    @Id private long id;
```

```

@Version private int version;

private Date startDate; // defaults to @Basic
private double payment; // defaults to @Basic

@OneToMany(cascade={CascadeType.PERSIST,CascadeType.REMOVE})
@MapKey(name="num")
private Map<Long,LineItem> lineItems;

...

@Entity
public static class LineItem
    extends Contract {

    private String comments; // defaults to @Basic
    private double price;    // defaults to @Basic
    private long num;        // defaults to @Basic

    @ManyToOne
    private Magazine magazine;

    ...
}

@Entity(name="Lifetime")
public class LifetimeSubscription
    extends Subscription {

    @Basic(fetch=FetchType.LAZY)
    private boolean getEliteClub() { ... }
    public void setEliteClub(boolean elite) { ... }

    ...
}

@Entity(name="Trial")
public class TrialSubscription
    extends Subscription {

    public Date getEndDate() { ... }
    public void setEndDate(Date end) { ... }

    ...
}

```

The same metadata declarations in XML:

```

<entity-mappings xmlns="http://java.sun.com/xml/ns/persistence/orm"
  xmlns:xsi="http://www.w3.org/2001/XMLSchema-instance"
  xsi:schemaLocation="http://java.sun.com/xml/ns/persistence/orm orm_1_0.xsd"
  version="1.0">
  <!-- declares a default access type for all entities -->
  <access-type>FIELD</access-type>
  <mapped-superclass class="org.mag.subscribe.Document">
    <attributes>
      <id name="id">
        <generated-value strategy="IDENTITY"/>
      </id>
      <version name="version"/>
    </attributes>
  </mapped-superclass>
  <entity class="org.mag.Magazine">
    <id-class="org.mag.Magazine$MagazineId"/>
    <attributes>
      <id name="isbn"/>
      <id name="title"/>
      <basic name="name"/>
      <basic name="price"/>
      <basic name="copiesSold"/>
      <version name="version"/>
      <many-to-one name="publisher" fetch="LAZY">

```

```

        <cascade>
          <cascade-persist/>
        </cascade>
      </many-to-one>
      <one-to-many name="articles">
        <order-by/>
        <cascade>
          <cascade-persist/>
          <cascade-remove/>
        </cascade>
      </one-to-many>
      <one-to-one name="coverArticle" fetch="LAZY">
        <cascade>
          <cascade-persist/>
          <cascade-remove/>
        </cascade>
      </one-to-one>
      <transient name="data" />
    </attributes>
  </entity>
  <entity class="org.mag.Article">
    <attributes>
      <id name="id" />
      <basic name="title" />
      <basic name="content" />
      <version name="version" />
      <many-to-many name="articles">
        <order-by>lastName, firstName</order-by>
      </many-to-many>
    </attributes>
  </entity>
  <entity class="org.mag.pub.Company">
    <attributes>
      <id name="id" />
      <basic name="name" />
      <basic name="revenue" />
      <version name="version" />
      <one-to-many name="mags" mapped-by="publisher">
        <cascade>
          <cascade-persist/>
        </cascade>
      </one-to-many>
      <one-to-many name="subscriptions">
        <cascade>
          <cascade-persist/>
          <cascade-remove/>
        </cascade>
      </one-to-many>
    </attributes>
  </entity>
  <entity class="org.mag.pub.Author">
    <attributes>
      <id name="id" />
      <basic name="firstName" />
      <basic name="lastName" />
      <version name="version" />
      <many-to-many name="arts" mapped-by="authors">
        <cascade>
          <cascade-persist/>
        </cascade>
      </many-to-many>
    </attributes>
  </entity>
  <entity class="org.mag.subscribe.Contract">
    <attributes>
      <basic name="terms" />
    </attributes>
  </entity>
  <entity class="org.mag.subscribe.Subscription">
    <attributes>
      <id name="id" />
      <basic name="payment" />
      <basic name="startDate" />
      <version name="version" />
      <one-to-many name="items">
        <map-key name="num">
          <cascade>
            <cascade-persist/>
          </cascade>
        </map-key>
      </one-to-many>
    </attributes>
  </entity>

```

```
        <cascade-remove/>
      </cascade>
    </one-to-many>
  </attributes>
</entity>
<entity class="org.mag.subscribe.Subscription.LineItem">
  <attributes>
    <basic name="comments"/>
    <basic name="price"/>
    <basic name="num"/>
    <many-to-one name="magazine"/>
  </attributes>
</entity>
<entity class="org.mag.subscribe.LifetimeSubscription" name="Lifetime"
  access="PROPERTY">
  <attributes>
    <basic name="eliteClub" fetch="LAZY"/>
  </attributes>
</entity>
<entity class="org.mag.subscribe.TrialSubscription" name="Trial">
  <attributes>
    <basic name="endDate"/>
  </attributes>
</entity>
<embeddable class="org.mag.pub.Address">
  <attributes>
    <basic name="street"/>
    <basic name="city"/>
    <basic name="state"/>
    <basic name="zip"/>
  </attributes>
</embeddable>
</entity-mappings>
```

**Chapter 13, *Mapping Metadata* [147]** will show you how to map your persistent classes to the datastore using additional annotations and XML markup. First, however, we turn to the JPA runtime APIs.



# Chapter 6. Persistence

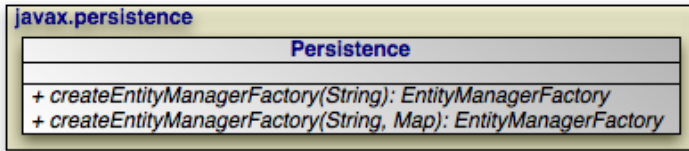

## Note

OpenJPA also includes the `OpenJPAPersistence` helper class to provide additional utility methods.

Within a container, you will typically use *injection* to access an `EntityManagerFactory`. Applications operating outside of a container, however, can use the `Persistence` class to obtain `EntityManagerFactory` objects in a vendor-neutral fashion.

```
public static EntityManagerFactory createEntityManagerFactory(String name);
public static EntityManagerFactory createEntityManagerFactory(String name, Map props);
public static PersistenceUtil getPersistenceUtil();
```

Each `createEntityManagerFactory` method searches the system for an `EntityManagerFactory` definition with the given name. Use `null` for an unnamed factory. The optional map contains vendor-specific property settings used to further configure the factory.

`persistence.xml` files define `EntityManagerFactories`. The `createEntityManagerFactory` methods search for `persistence.xml` files within the `META-INF` directory of any `CLASSPATH` element. For example, if your `CLASSPATH` contains the `conf` directory, you could place an `EntityManagerFactory` definition in `conf/META-INF/persistence.xml`.

The `getPersistenceUtil` method returns a `PersistenceUtil` interface that can be used to determine whether an entity or attribute of an entity is loaded.

```
PersistenceUtil pUtil = Persistence.getPersistenceUtil();

if (!pUtil.isLoaded(myEntity)) {
    loadEntity(myEntity);
}
```

## 6.1. persistence.xml

With the introduction of JPA 2.0, there are two versions of the `persistence.xml`. The most current revision of the 2.0 persistence schema is presented below. Version 1.0 of the persistence schema can be found at [http://java.sun.com/xml/ns/persistence/persistence\\_1\\_0.xsd](http://java.sun.com/xml/ns/persistence/persistence_1_0.xsd).

```
<?xml version="1.0" encoding="UTF-8"?>
<!-- persistence.xml schema -->
<xsd:schema targetNamespace="http://java.sun.com/xml/ns/persistence"
  xmlns:xsd="http://www.w3.org/2001/XMLSchema"
  xmlns:persistence="http://java.sun.com/xml/ns/persistence"
```

```

elementFormDefault="qualified" attributeFormDefault="unqualified"
version="2.0">

<xsd:annotation>
  <xsd:documentation>
    @(#)persistence_2_0.xsd 1.0 October 1 2009
  </xsd:documentation>
</xsd:annotation>

<xsd:annotation>
  <xsd:documentation>

    DO NOT ALTER OR REMOVE COPYRIGHT NOTICES OR THIS HEADER.

    Copyright 2005-2009 Sun Microsystems, Inc. All rights reserved.

    The contents of this file are subject to the terms of either the
    GNU General Public License Version 2 only ("GPL") or the Common
    Development and Distribution License("CDDL") (collectively, the
    "License"). You may not use this file except in compliance with
    the License. You can obtain a copy of the License at
    https://glassfish.dev.java.net/public/CDDL+GPL.html or
    glassfish/bootstrap/legal/LICENSE.txt. See the License for the
    specific language governing permissions and limitations under the
    License.

    When distributing the software, include this License Header
    Notice in each file and include the License file at
    glassfish/bootstrap/legal/LICENSE.txt. Sun designates this
    particular file as subject to the "Classpath" exception as
    provided by Sun in the GPL Version 2 section of the License file
    that accompanied this code. If applicable, add the following
    below the License Header, with the fields enclosed by brackets []
    replaced by your own identifying information:
    "Portions Copyrighted [year] [name of copyright owner]"

    Contributor(s):

    If you wish your version of this file to be governed by only the
    CDDL or only the GPL Version 2, indicate your decision by adding
    "[Contributor] elects to include this software in this
    distribution under the [CDDL or GPL Version 2] license." If you
    don't indicate a single choice of license, a recipient has the
    option to distribute your version of this file under either the
    CDDL, the GPL Version 2 or to extend the choice of license to its
    licensees as provided above. However, if you add GPL Version 2
    code and therefore, elected the GPL Version 2 license, then the
    option applies only if the new code is made subject to such
    option by the copyright holder.

  </xsd:documentation>
</xsd:annotation>

<xsd:annotation>
  <xsd:documentation>
    <![CDATA[
      This is the XML Schema for the persistence configuration file.
      The file must be named "META-INF/persistence.xml" in the
      persistence archive.
      Persistence configuration files must indicate
      the persistence schema by using the persistence namespace:
      http://java.sun.com/xml/ns/persistence
      and indicate the version of the schema by
      using the version element as shown below:
      <persistence xmlns="http://java.sun.com/xml/ns/persistence"
      xmlns:xsi="http://www.w3.org/2001/XMLSchema-instance"
      xsi:schemaLocation="http://java.sun.com/xml/ns/persistence
      http://java.sun.com/xml/ns/persistence/persistence_2_0.xsd"
      version="2.0">
      ...
      </persistence>
    ]]>
  </xsd:documentation>
</xsd:annotation>

<xsd:simpleType name="versionType">
  <xsd:restriction base="xsd:token">
    <xsd:pattern value="[0-9]+(\.[0-9]+)*" />

```

```

    </xsd:restriction>
</xsd:simpleType>
<!-- ***** -->
<xsd:element name="persistence">
  <xsd:complexType>
    <xsd:sequence>
      <!-- ***** -->
      <xsd:element name="persistence-unit"
        minOccurs="1" maxOccurs="unbounded">
        <xsd:complexType>
          <xsd:annotation>
            <xsd:documentation>
              Configuration of a persistence unit.
            </xsd:documentation>
          </xsd:annotation>
          <xsd:sequence>
            <!-- ***** -->
            <xsd:element name="description"
              type="xsd:string" minOccurs="0">
              <xsd:annotation>
                <xsd:documentation>
                  Description of this persistence unit.
                </xsd:documentation>
              </xsd:annotation>
            </xsd:element>
            <!-- ***** -->
            <xsd:element name="provider"
              type="xsd:string" minOccurs="0">
              <xsd:annotation>
                <xsd:documentation>
                  Provider class that supplies EntityManagers for this
                  persistence unit.
                </xsd:documentation>
              </xsd:annotation>
            </xsd:element>
            <!-- ***** -->
            <xsd:element name="jta-data-source"
              type="xsd:string" minOccurs="0">
              <xsd:annotation>
                <xsd:documentation>
                  The container-specific name of the JTA datasource to use.
                </xsd:documentation>
              </xsd:annotation>
            </xsd:element>
            <!-- ***** -->
            <xsd:element name="non-jta-data-source"
              type="xsd:string" minOccurs="0">
              <xsd:annotation>
                <xsd:documentation>
                  The container-specific name of a non-JTA datasource to use.
                </xsd:documentation>
              </xsd:annotation>
            </xsd:element>
            <!-- ***** -->
            <xsd:element name="mapping-file"
              type="xsd:string" minOccurs="0"
              maxOccurs="unbounded">
              <xsd:annotation>
                <xsd:documentation>
                  File containing mapping information. Loaded as a resource
                  by the persistence provider.
                </xsd:documentation>
              </xsd:annotation>
            </xsd:element>
            <!-- ***** -->
            <xsd:element name="jar-file"
              type="xsd:string" minOccurs="0"
              maxOccurs="unbounded">
              <xsd:annotation>
                <xsd:documentation>
                  Jar file that is to be scanned for managed classes.
                </xsd:documentation>
              </xsd:annotation>
            </xsd:element>
            <!-- ***** -->
            <xsd:element name="class" type="xsd:string"
              minOccurs="0" maxOccurs="unbounded">
              <xsd:annotation>

```

```

        <xsd:documentation>
            Managed class to be included in the persistence unit and
            to scan for annotations. It should be annotated
            with either @Entity, @Embeddable or @MappedSuperclass.
        </xsd:documentation>
    </xsd:annotation>
</xsd:element>
<!-- ***** -->
<xsd:element name="exclude-unlisted-classes"
    type="xsd:boolean" default="true"
    minOccurs="0">
    <xsd:documentation>
        <xsd:documentation>
            When set to true then only listed classes and jars will
            be scanned for persistent classes, otherwise the
            enclosing jar or directory will also be scanned.
            Not applicable to Java SE persistence units.
        </xsd:documentation>
    </xsd:documentation>
</xsd:annotation>
</xsd:element>
<!-- ***** -->
<xsd:element name="shared-cache-mode"
    type="persistence:persistence-unit-caching-type"
    minOccurs="0">
    <xsd:documentation>
        <xsd:documentation>
            Defines whether caching is enabled for the
            persistence unit if caching is supported by the
            persistence provider. When set to ALL, all entities
            will be cached. When set to NONE, no entities will
            be cached. When set to ENABLE_SELECTIVE, only entities
            specified as cacheable will be cached. When set to
            DISABLE_SELECTIVE, entities specified as not cacheable
            will not be cached. When not specified or when set to
            UNSPECIFIED, provider defaults may apply.
        </xsd:documentation>
    </xsd:documentation>
</xsd:annotation>
</xsd:element>
<!-- ***** -->
<xsd:element name="validation-mode"
    type="persistence:persistence-unit-validation-mode-type"
    minOccurs="0">
    <xsd:documentation>
        <xsd:documentation>
            The validation mode to be used for the persistence unit.
        </xsd:documentation>
    </xsd:documentation>
</xsd:annotation>
</xsd:element>
<!-- ***** -->
<xsd:element name="properties"
    minOccurs="0">
    <xsd:documentation>
        <xsd:documentation>
            A list of standard and vendor-specific properties
            and hints.
        </xsd:documentation>
    </xsd:documentation>
</xsd:annotation>
<xsd:complexType>
    <xsd:sequence>
        <xsd:element name="property"
            minOccurs="0" maxOccurs="unbounded">
            <xsd:documentation>
                <xsd:documentation>
                    A name-value pair.
                </xsd:documentation>
            </xsd:documentation>
            <xsd:complexType>
                <xsd:attribute
                    name="name" type="xsd:string"
                    use="required" />
                <xsd:attribute
                    name="value" type="xsd:string"
                    use="required" />
            </xsd:complexType>
        </xsd:element>
    </xsd:sequence>
</xsd:complexType>
</xsd:element>

```

```

</xsd:sequence>
<!-- ***** -->
<xsd:attribute name="name" type="xsd:string"
  use="required">
  <xsd:annotation>
    <xsd:documentation>
      Name used in code to reference this persistence unit.
    </xsd:documentation>
  </xsd:annotation>
</xsd:attribute>
<!-- ***** -->
<xsd:attribute name="transaction-type"
  type="persistence:persistence-unit-transaction-type">
  <xsd:annotation>
    <xsd:documentation>
      Type of transactions used by EntityManagers from this
      persistence unit.
    </xsd:documentation>
  </xsd:annotation>
</xsd:attribute>
</xsd:complexType>
</xsd:element>
</xsd:sequence>
<xsd:attribute name="version" type="persistence:versionType"
  fixed="2.0" use="required" />
</xsd:complexType>
</xsd:element>
<!-- ***** -->
<xsd:simpleType name="persistence-unit-transaction-type">
  <xsd:annotation>
    <xsd:documentation>
      public enum PersistenceUnitTransactionType {JTA, RESOURCE_LOCAL};
    </xsd:documentation>
  </xsd:annotation>
  <xsd:restriction base="xsd:token">
    <xsd:enumeration value="JTA" />
    <xsd:enumeration value="RESOURCE_LOCAL" />
  </xsd:restriction>
</xsd:simpleType>
<!-- ***** -->
<xsd:simpleType name="persistence-unit-caching-type">
  <xsd:annotation>
    <xsd:documentation>
      public enum SharedCacheMode { ALL, NONE, ENABLE_SELECTIVE,
      DISABLE_SELECTIVE, UNSPECIFIED};
    </xsd:documentation>
  </xsd:annotation>
  <xsd:restriction base="xsd:token">
    <xsd:enumeration value="ALL" />
    <xsd:enumeration value="NONE" />
    <xsd:enumeration value="ENABLE_SELECTIVE" />
    <xsd:enumeration value="DISABLE_SELECTIVE" />
    <xsd:enumeration value="UNSPECIFIED" />
  </xsd:restriction>
</xsd:simpleType>
<!-- ***** -->
<xsd:simpleType name="persistence-unit-validation-mode-type">
  <xsd:annotation>
    <xsd:documentation>
      public enum ValidationMode { AUTO, CALLBACK, NONE};
    </xsd:documentation>
  </xsd:annotation>
  <xsd:restriction base="xsd:token">
    <xsd:enumeration value="AUTO" />
    <xsd:enumeration value="CALLBACK" />
    <xsd:enumeration value="NONE" />
  </xsd:restriction>
</xsd:simpleType>
</xsd:schema>

```

The root element of a `persistence.xml` file is `persistence`, which then contains one or more `persistence-unit` definitions. The root element should include the `version` attribute with the appropriate version, 1.0 for a version 1.0 file and 2.0 for a version 2.0 file. Each persistence unit describes the configuration for the entity managers created by the persistence unit's entity manager factory. The persistence unit can specify these elements and attributes.

- `name`: This is the name you pass to the `Persistence.createEntityManagerFactory` methods described above. The `name` attribute is required.
- `transaction-type`: Whether to use managed (JTA) or local (RESOURCE\_LOCAL) transaction management.
- `provider`: If you are using a third-party JPA vendor, this element names its implementation of the `PersistenceProvider` bootstrapping interface.

### Note

Set the `provider` to `org.apache.openjpa.persistence.PersistenceProviderImpl` to use OpenJPA.

- `jta-data-source`: The JNDI name of a JDBC `DataSource` that is automatically enlisted in JTA transactions. This may be an XA `DataSource`.
- `non-jta-data-source`: The JNDI name of a JDBC `DataSource` that is not enlisted in JTA transactions.
- `mapping-file*`: The resource names of XML mapping files for entities and embeddable classes. You can also specify mapping information in an `orm.xml` file in your `META-INF` directory. If present, the `orm.xml` mapping file will be read automatically.
- `jar-file*`: The names of jar files containing entities and embeddable classes. The implementation will scan the jar for annotated classes.
- `class*`: The class names of entities and embeddable classes.
- `properties`: This element contains nested `property` elements used to specify vendor-specific settings. Each `property` has a `name` attribute and a `value` attribute.

### Note

The Reference Guide's [Chapter 2, Configuration](#) [208] describes OpenJPA's configuration properties.

Here is a typical `persistence.xml` file for a non-EE environment:

#### Example 6.1. `persistence.xml`

```
<?xml version="1.0"?>
<persistence version="1.0">
  <persistence-unit name="openjpa">
    <provider>org.apache.openjpa.persistence.PersistenceProviderImpl</provider>
    <class>tutorial.Animal</class>
    <class>tutorial.Dog</class>
    <class>tutorial.Rabbit</class>
    <class>tutorial.Snake</class>
    <properties>
      <property name="openjpa.ConnectionURL" value="jdbc:hsqldb:tutorial_database"/>
      <property name="openjpa.ConnectionDriverName" value="org.hsqldb.jdbcDriver"/>
      <property name="openjpa.ConnectionUserName" value="sa"/>
      <property name="openjpa.ConnectionPassword" value=""/>
      <property name="openjpa.Log" value="DefaultLevel=WARN, Tool=INFO"/>
    </properties>
  </persistence-unit>
</persistence>
```

## 6.2. Non-EE Use

---

The example below demonstrates the `Persistence` class in action. You will typically execute code like this on application startup, then cache the resulting factory for future use. This bootstrapping code is only necessary in non-EE environments; in an EE environment `EntityManagerFactories` are typically injected.

### *Example 6.2. Obtaining an EntityManagerFactory*

```
// if your persistence.xml file does not contain all settings already, you
// can add vendor settings to a map
Properties props = new Properties();
...

// create the factory defined by the "openjpa" entity-manager entry
EntityManagerFactory emf = Persistence.createEntityManagerFactory("openjpa", props);
```

---

# Chapter 7. EntityManagerFactory

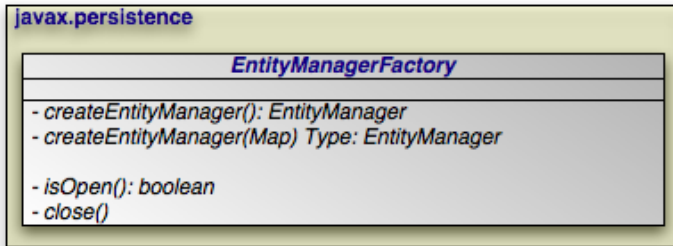

The `EntityManagerFactory` creates `EntityManager` instances for application use.

## Note

OpenJPA extends the standard `EntityManagerFactory` interface with the `OpenJPAEntityManagerFactory` to provide additional functionality.

---

## 7.1. Obtaining an EntityManagerFactory

Within a container, you will typically use *injection* to access an `EntityManagerFactory`. There are, however, alternative mechanisms for `EntityManagerFactory` construction.

Some vendors may supply public constructors for their `EntityManagerFactory` implementations, but we recommend using the Java Connector Architecture (JCA) in a managed environment, or the `Persistence` class' `createEntityManagerFactory` methods in an unmanaged environment, as described in **Chapter 6, Persistence [69]**. These strategies allow vendors to pool factories, cutting down on resource utilization.

JPA allows you to create and configure an `EntityManagerFactory`, then store it in a Java Naming and Directory Interface (JNDI) tree for later retrieval and use.

---

## 7.2. Obtaining EntityManagers

```
public EntityManager createEntityManager();  
public EntityManager createEntityManager(Map map);
```

The two `createEntityManager` methods above create a new `EntityManager` each time they are invoked. The optional `Map` is used to supply vendor-specific settings. If you have configured your implementation for JTA transactions and a JTA transaction is active, the returned `EntityManager` will be synchronized with that transaction.

## Note

OpenJPA recognizes the following string keys in the map supplied to `createEntityManager`:

- `openjpa.ConnectionUserName`
- `openjpa.ConnectionPassword`



- `openjpa.ConnectionRetainMode`
- `openjpa.TransactionMode`
- `openjpa.<property>`, where *<property>* is any JavaBean property of the `org.apache.openjpa.persistence.OpenJPAEntityManager`.

The last option uses reflection to configure any property of OpenJPA's `EntityManager` implementation with the value supplied in your map. The first options correspond exactly to the same-named OpenJPA configuration keys described in [Chapter 2, Configuration \[208\]](#) of the Reference Guide.

## 7.3. Persistence Context

A persistence context is a set of entities such that for any persistent identity there is a unique entity instance. Within a persistence context, entities are *managed*. The `EntityManager` controls their lifecycle, and they can access datastore resources.

When a persistence context ends, previously-managed entities become *detached*. A detached entity is no longer under the control of the `EntityManager`, and no longer has access to datastore resources. We discuss detachment in detail in [Section 8.2, “Entity Lifecycle Management” \[82\]](#). For now, it is sufficient to know that detachment has two obvious consequences:

1. The detached entity cannot load any additional persistent state.
2. The `EntityManager` will not return the detached entity from `find`, nor will queries include the detached entity in their results. Instead, `find` method invocations and query executions that would normally incorporate the detached entity will create a new managed entity with the same identity.

### Note

OpenJPA offers several features related to detaching entities. See [Section 12.1, “Detach and Attach” \[364\]](#) in the Reference Guide. [Section 12.1.3, “Defining the Detached Object Graph” \[365\]](#) in particular describes how to use the `DetachState` setting to boost the performance of merging detached entities.

Injected `EntityManager`s have a *transaction* persistence context, while `EntityManager`s obtained through the `EntityManagerFactory` have an *extended* persistence context. We describe these persistence context types below.

### 7.3.1. Transaction Persistence Context

Under the transaction persistence context model, an `EntityManager` begins a new persistence context with each transaction, and ends the context when the transaction commits or rolls back. Within the transaction, entities you retrieve through the `EntityManager` or via `Queries` are managed entities. They can access datastore resources to lazy-load additional persistent state as needed, and only one entity may exist for any persistent identity.

When the transaction completes, all entities lose their association with the `EntityManager` and become detached. Traversing a persistent field that wasn't already loaded now has undefined results. And using the `EntityManager` or a `Query` to retrieve additional objects may now create new instances with the same persistent identities as detached instances.

If you use an `EntityManager` with a transaction persistence context model outside of an active transaction, each method invocation creates a new persistence context, performs the method action, and ends the persistence context. For example, consider using the `EntityManager.find` method outside of a transaction. The `EntityManager` will create a temporary persistence context, perform the find operation, end the persistence context, and return the detached result object to you. A second call with the same id will return a second detached object.

When the next transaction begins, the `EntityManager` will begin a new persistence context, and will again start returning managed entities. As you'll see in [Chapter 8, EntityManager \[81\]](#), you can also merge the previously-detached entities back into the new persistence context.

**Example 7.1. Behavior of Transaction Persistence Context**

The following code illustrates the behavior of entities under an `EntityManager` using a transaction persistence context.

```
EntityManager em; // injected
...

// outside a transaction:

// each operation occurs in a separate persistence context, and returns
// a new detached instance
Magazine mag1 = em.find(Magazine.class, magId);
Magazine mag2 = em.find(Magazine.class, magId);
assertTrue(mag2 != mag1);
...

// transaction begins:

// within a transaction, a subsequent lookup doesn't return any of the
// detached objects. however, two lookups within the same transaction
// return the same instance, because the persistence context spans the
// transaction
Magazine mag3 = em.find(Magazine.class, magId);
assertTrue(mag3 != mag1 && mag3 != mag2);
Magazine mag4 = em.find(Magazine.class, magId);
assertTrue(mag4 == mag3);
...

// transaction commits:

// once again, each operation returns a new instance
Magazine mag5 = em.find(Magazine.class, magId);
assertTrue(mag5 != mag3);
```

## 7.3.2. Extended Persistence Context

An `EntityManager` using an extended persistence context maintains the same persistence context for its entire lifecycle. Whether inside a transaction or not, all entities returned from the `EntityManager` are managed, and the `EntityManager` never creates two entity instances to represent the same persistent identity. Entities only become detached when you finally close the `EntityManager` (or when they are serialized).

**Example 7.2. Behavior of Extended Persistence Context**

The following code illustrates the behavior of entities under an `EntityManager` using an extended persistence context.

```
EntityManagerFactory emf = ...
EntityManager em = emf.createEntityManager();

// persistence context active for entire life of EM, so only one entity
// for a given persistent identity
Magazine mag1 = em.find(Magazine.class, magId);
Magazine mag2 = em.find(Magazine.class, magId);
assertTrue(mag2 == mag1);

em.getTransaction().begin();

// same persistence context active within the transaction
Magazine mag3 = em.find(Magazine.class, magId);
assertTrue(mag3 == mag1);
Magazine mag4 = em.find(Magazine.class, magId);
assertTrue(mag4 == mag1);

em.getTransaction.commit();
```

```
// when the transaction commits, instance still managed
Magazine mag5 = em.find(Magazine.class, magId);
assertTrue(mag5 == mag1);

// instance finally becomes detached when EM closes
em.close();
```

## 7.4. Retrieving Properties Information

There are two sets of properties that may be specified: those that are specific to OpenJPA and those that have been defined by the JPA specification. In some cases, two properties may be equivalent, but have different keys. For example, *openjpa.LockTimeout* and *javax.persistence.lock.timeout* are two different keys for the same property.

There are two methods that can be used to retrieve information related to properties:

```
public Map<String, Object> getProperties();
public Set<String> getSupportedProperties();
```

- `getProperties` - Provides a list of current properties. If a property has more than one key, the key that will be returned is the one that was used when the property was set. If the property was not explicitly set, the key defined by the JPA specification will be returned with the default value.
- `getSupportedProperties` - Returns a set of supported property keys. This includes keys defined by the JPA specification as well as keys specific to OpenJPA. If a property has more than one key, all possible keys will be returned.

### Note

The `getSupportedProperties` method is an OpenJPA extension to the JPA specification.

## 7.5. Closing the EntityManagerFactory

```
public boolean isOpen();
public void close();
```

`EntityManagerFactory` instances are heavyweight objects. Each factory might maintain a metadata cache, object state cache, `EntityManager` pool, connection pool, and more. If your application no longer needs an `EntityManagerFactory`, you should close it to free these resources. When an `EntityManagerFactory` closes, all `EntityManagers` from that factory, and by extension all entities managed by those `EntityManagers`, become invalid. Attempting to close an `EntityManagerFactory` while one or more of its `EntityManagers` has an active transaction may result in an `IllegalStateException`.

Closing an `EntityManagerFactory` should not be taken lightly. It is much better to keep a factory open for a long period of time than to repeatedly create and close new factories. Thus, most applications will never close the factory, or only close it when the application is exiting. Only applications that require multiple factories with different configurations have an obvious reason to create and close multiple `EntityManagerFactory` instances. Once a factory is closed, all methods except `isOpen` throw an `IllegalStateException`.

## 7.6. PersistenceUnitUtil

```
public PersistenceUnitUtil getPersistenceUnitUtil();
```

The `EntityManagerFactory` method `getPersistenceUnitUtil` provides access to a `PersistenceUnitUtil` utility. `PersistenceUnitUtil` can be used to obtain the identity of a managed object and determine the load state of the entity or one of its attributes. If the object is not managed by one of the entity managers created from the entity manager factory from which the utility was obtained, the `getIdentifier` method will return null and the `isLoading` methods will return false.

```
EntityManagerFactory emf = Persistence.createEntityManagerFactory();
PersistenceUnitUtil puUtil = emf.getPersistenceUnitUtil();

if (puUtil.getIdentifier(deptEntity) == null) {
    throw new Exception("Identity is not valid.");
}
if (!puUtil.isLoading(deptEntity, "employees")) {
    throw new Exception("Employees not loaded.");
}
```

---

# Chapter 8. EntityManager

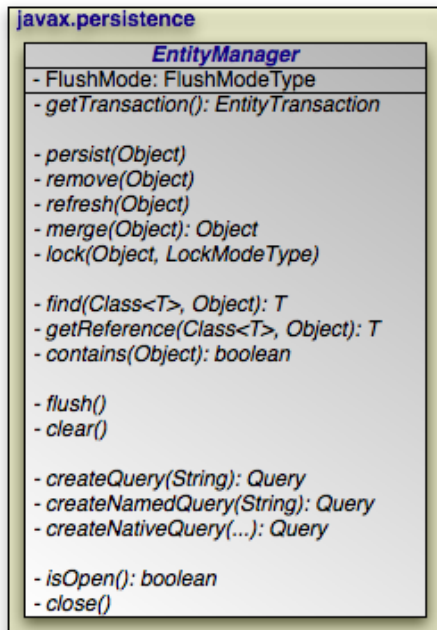

The diagram above presents an overview of the `EntityManager` interface. For a complete treatment of the `EntityManager` API, see the **Javadoc** documentation. Methods whose parameter signatures consist of an ellipsis (...) are overloaded to take multiple parameter types.

## Note

OpenJPA extends the standard `EntityManager` interface with the `org.apache.openjpa.persistence.OpenJPAEntityManager` interface to provide additional functionality.

The `EntityManager` is the primary interface used by application developers to interact with the JPA runtime. The methods of the `EntityManager` can be divided into the following functional categories:

- Transaction association.
- Entity lifecycle management.
- Entity identity management.
- Cache management.
- Query factory.
- Entity locking.
- Closing.

## 8.1. Transaction Association

---

```
public EntityTransaction getTransaction();
```

Every `EntityManager` has a one-to-one relation with an `EntityTransaction` instance. In fact, many vendors use a single class to implement both the `EntityManager` and `EntityTransaction` interfaces. If your application requires multiple concurrent transactions, you will use multiple `EntityManager`s.

You can retrieve the `EntityTransaction` associated with an `EntityManager` through the `getTransaction` method. Note that most JPA implementations can integrate with an application server's managed transactions. If you take advantage of this feature, you will control transactions by declarative demarcation or through the Java Transaction API (JTA) rather than through the `EntityTransaction`.

## 8.2. Entity Lifecycle Management

`EntityManager`s perform several actions that affect the lifecycle state of entity instances.

```
public void persist(Object entity);
```

Transitions new instances to managed. On the next flush or commit, the newly persisted instances will be inserted into the datastore.

For a given entity *A*, the `persist` method behaves as follows:

- If *A* is a new entity, it becomes managed.
- If *A* is an existing managed entity, it is ignored. However, the `persist` operation cascades as defined below.
- If *A* is a removed entity, it becomes managed.
- If *A* is a detached entity, an `IllegalArgumentException` is thrown.
- The `persist` operation recurses on all relation fields of *A* whose **cascades** include `CascadeType.PERSIST`.

This action can only be used in the context of an active transaction.

```
public void remove(Object entity);
```

Transitions managed instances to removed. The instances will be deleted from the datastore on the next flush or commit. Accessing a removed entity has undefined results.

For a given entity *A*, the `remove` method behaves as follows:

- If *A* is a new entity, it is ignored. However, the `remove` operation cascades as defined below.
- If *A* is an existing managed entity, it becomes removed.
- If *A* is a removed entity, it is ignored.
- If *A* is a detached entity, an `IllegalArgumentException` is thrown.
- The `remove` operation recurses on all relation fields of *A* whose **cascades** include `CascadeType.REMOVE`.

This action can only be used in the context of an active transaction.

```
public void refresh(Object entity);
```

Use the `refresh` action to make sure the persistent state of an instance is synchronized with the values in the datastore. `refresh` is intended for long-running optimistic transactions in which there is a danger of seeing stale data.

For a given entity A, the `refresh` method behaves as follows:

- If A is a new entity, it is ignored. However, the refresh operation cascades as defined below.
- If A is an existing managed entity, its state is refreshed from the datastore.
- If A is a removed entity, it is ignored.
- If A is a detached entity, an `IllegalArgumentException` is thrown.
- The refresh operation recurses on all relation fields of A whose **cascades** include `CascadeType.REFRESH`.

```
public Object merge(Object entity);
```

A common use case for an application running in a servlet or application server is to "detach" objects from all server resources, modify them, and then "attach" them again. For example, a servlet might store persistent data in a user session between a modification based on a series of web forms. Between each form request, the web container might decide to serialize the session, requiring that the stored persistent state be disassociated from any other resources. Similarly, a client/server application might transfer persistent objects to a client via serialization, allow the client to modify their state, and then have the client return the modified data in order to be saved. This is sometimes referred to as the *data transfer object* or *value object* pattern, and it allows fine-grained manipulation of data objects without incurring the overhead of multiple remote method invocations.

JPA provides support for this pattern by automatically detaching entities when they are serialized or when a persistence context ends (see [Section 7.3, “Persistence Context” \[77\]](#) for an exploration of persistence contexts). The JPA `merge` API re-attaches detached entities. This allows you to detach a persistent instance, modify the detached instance offline, and merge the instance back into an `EntityManager` (either the same one that detached the instance, or a new one). The changes will then be applied to the existing instance from the datastore.

A detached entity maintains its persistent identity, but cannot load additional state from the datastore. Accessing any persistent field or property that was not loaded at the time of detachment has undefined results. Also, be sure not to alter the version or identity fields of detached instances if you plan on merging them later.

The `merge` method returns a managed copy of the given detached entity. Changes made to the persistent state of the detached entity are applied to this managed instance. Because merging involves changing persistent state, you can only merge within a transaction.

If you attempt to merge an instance whose representation has changed in the datastore since detachment, the merge operation will throw an exception, or the transaction in which you perform the merge will fail on commit, just as if a normal optimistic conflict were detected.

## Note

OpenJPA offers enhancements to JPA detachment functionality, including additional options to control which fields are detached. See [Section 12.1, “Detach and Attach” \[364\]](#) in the Reference Guide for details.

For a given entity A, the merge method behaves as follows:

- If A is a detached entity, its state is copied into existing managed instance A' of the same entity identity, or a new managed copy of A is created.
- If A is a new entity, a new managed entity A' is created and the state of A is copied into A'.
- If A is an existing managed entity, it is ignored. However, the merge operation still cascades as defined below.
- If A is a removed entity, an `IllegalArgumentException` is thrown.
- The merge operation recurses on all relation fields of A whose **cascades** include `CascadeType.MERGE`.

The following diagram illustrates the lifecycle of an entity with respect to the APIs presented in this section.

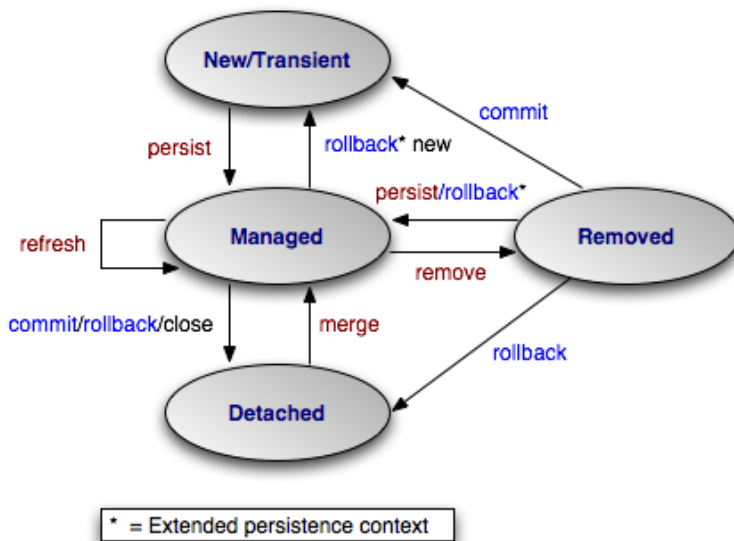

## 8.3. Lifecycle Examples

The examples below demonstrate how to use the lifecycle methods presented in the previous section. The examples are appropriate for out-of-container use. Within a container, `EntityManagers` are usually injected, and transactions are usually managed. You would therefore omit the `createEntityManager` and `close` calls, as well as all transaction demarcation code.

### Example 8.1. Persisting Objects

```

// create some objects
Magazine mag = new Magazine("1B78-YU9L", "JavaWorld");

Company pub = new Company("Weston House");
pub.setRevenue(1750000D);
mag.setPublisher(pub);
pub.addMagazine(mag);

Article art = new Article("JPA Rules!", "Transparent Object Persistence");
art.addAuthor(new Author("Fred", "Hoyle"));
mag.addArticle(art);

// persist
    
```



```
EntityManager em = emf.createEntityManager();
em.getTransaction().begin();
em.persist(mag);
em.persist(pub);
em.persist(art);
em.getTransaction().commit();

// or we could continue using the EntityManager...
em.close();
```

### ***Example 8.2. Updating Objects***

```
Magazine.MagazineId mi = new Magazine.MagazineId();
mi.isbn = "1B78-YU9L";
mi.title = "JavaWorld";

// updates should always be made within transactions; note that
// there is no code explicitly linking the magazine or company
// with the transaction; JPA automatically tracks all changes
EntityManager em = emf.createEntityManager();
em.getTransaction().begin();
Magazine mag = em.find(Magazine.class, mi);
mag.setPrice(5.99);
Company pub = mag.getPublisher();
pub.setRevenue(1750000D);
em.getTransaction().commit();

// or we could continue using the EntityManager...
em.close();
```

### ***Example 8.3. Removing Objects***

```
// assume we have an object id for the company whose subscriptions
// we want to delete
Object oid = ...;

// deletes should always be made within transactions
EntityManager em = emf.createEntityManager();
em.getTransaction().begin();
Company pub = (Company) em.find(Company.class, oid);
for (Subscription sub : pub.getSubscriptions())
    em.remove(sub);
pub.getSubscriptions().clear();
em.getTransaction().commit();

// or we could continue using the EntityManager...
em.close();
```

### ***Example 8.4. Detaching and Merging***

This example demonstrates a common client/server scenario. The client requests objects and makes changes to them, while the server handles the object lookups and transactions.

```
// CLIENT:
// requests an object with a given oid
Record detached = (Record) getFromServer(oid);

...

```

```

// SERVER:
// send object to client; object detaches on EM close
Object oid = processClientRequest();
EntityManager em = emf.createEntityManager();
Record record = em.find(Record.class, oid);
em.close();
sendToClient(record);

...

// CLIENT:
// makes some modifications and sends back to server
detached.setSomeField("bar");
sendToServer(detached);

...

// SERVER:
// merges the instance and commit the changes
Record modified = (Record) processClientRequest();
EntityManager em = emf.createEntityManager();
em.getTransaction().begin();
Record merged = (Record) em.merge(modified);
merged.setLastModified(System.currentTimeMillis());
merged.setModifier(getClientIdentityCode());
em.getTransaction().commit();
em.close();

```

## 8.4. Entity Identity Management

Each `EntityManager` is responsible for managing the persistent identities of the managed objects in the persistence context. The following methods allow you to interact with the management of persistent identities. The behavior of these methods is deeply affected by the persistence context type of the `EntityManager`; see [Section 7.3, “Persistence Context” \[77\]](#) for an explanation of persistence contexts.

```
public <T> T find(Class<T> cls, Object oid);
```

This method returns the persistent instance of the given type with the given persistent identity. If the instance is already present in the current persistence context, the cached version will be returned. Otherwise, a new instance will be constructed and loaded with state from the datastore. If no entity with the given type and identity exists in the datastore, this method returns null.

```
public <T> T getReference(Class<T> cls, Object oid);
```

This method is similar to `find`, but does not necessarily go to the database when the entity is not found in cache. The implementation may construct a *hollow* entity and return it to you instead. Hollow entities do not have any state loaded. The state only gets loaded when you attempt to access a persistent field. At that time, the implementation may throw an `EntityNotFoundException` if it discovers that the entity does not exist in the datastore. The implementation may also throw an `EntityNotFoundException` from the `getReference` method itself. Unlike `find`, `getReference` does not return null.

```
public boolean contains(Object entity);
```

Returns true if the given entity is part of the current persistence context, and false otherwise. Removed entities are not considered part of the current persistence context.

## 8.5. Cache Management

```
public void flush();
```

The `flush` method writes any changes that have been made in the current transaction to the datastore. If the `EntityManager` does not already have a connection to the datastore, it obtains one for the flush and retains it for the duration of the transaction. Any exceptions during flush cause the transaction to be marked for rollback. See [Chapter 9, Transaction \[90\]](#).

Flushing requires an active transaction. If there isn't a transaction in progress, the `flush` method throws a `TransactionRequiredException`.

```
public FlushModeType getFlushMode();
public void setFlushMode(FlushModeType flushMode);
```

The `EntityManager`'s `FlushMode` property controls whether to flush transactional changes before executing queries. This allows the query results to take into account changes you have made during the current transaction. Available `javax.persistence.FlushModeType` constants are:

- `COMMIT`: Only flush when committing, or when told to do so through the `flush` method. Query results may not take into account changes made in the current transaction.
- `AUTO`: The implementation is permitted to flush before queries to ensure that the results reflect the most recent object state.

You can also set the flush mode on individual `Query` instances.

### Note

OpenJPA only flushes before a query if the query might be affected by data changed in the current transaction. Additionally, OpenJPA allows fine-grained control over flushing behavior. See the Reference Guide's [Section 4.8, “Configuring the Use of JDBC Connections” \[262\]](#).

```
public void clear();
```

Clearing the `EntityManager` effectively ends the persistence context. All entities managed by the `EntityManager` become detached.

## 8.6. Query Factory

```
public Query createQuery(String query);
```

`Query` objects are used to find entities matching certain criteria. The `createQuery` method creates a query using the given Java Persistence Query Language (JPQL) string. See [Chapter 10, JPA Query \[93\]](#) for details.

```
public Query createNamedQuery(String name);
```

This method retrieves a query defined in metadata by name. The returned `Query` instance is initialized with the information declared in metadata. For more information on named queries, read [Section 10.1.11, “Named Queries” \[104\]](#).

```
public Query createNativeQuery(String sql);
public Query createNativeQuery(String sql, Class resultCls);
public Query createNativeQuery(String sql, String resultMapping);
```

*Native* queries are queries in the datastore's native language. For relational databases, this is the Structured Query Language (SQL). [Chapter 12, \*SQL Queries\* \[145\]](#) elaborates on JPA's native query support.

## 8.7. Entity Locking

In the area of concurrency control, the JPA specification supports optimistic and pessimistic locking.

```
public void lock(Object entity, LockModeType mode);
```

This method locks the given entity using the named mode. The `javax.persistence.LockModeType` enum defines eight modes:

- `OPTIMISTIC`: Optimistic locking.
- `OPTIMISTIC_FORCE_INCREMENT`: Optimistic locking. When a transaction is committed, the entity's version column will be incremented even if the entity's state did not change in the transaction.
- `PESSIMISTIC_READ`: Pessimistic locking. Other transactions may concurrently read the entity, but cannot concurrently update it.
- `PESSIMISTIC_WRITE`: Pessimistic locking. Other transactions cannot concurrently read or write the entity.
- `PESSIMISTIC_FORCE_INCREMENT`: Pessimistic locking. Other transactions cannot concurrently read or write the entity. When a transaction is committed, the entity's version column will be incremented even if the entity's state did not change in the transaction.
- `READ`: A synonym for `OPTIMISTIC`.
- `WRITE`: A synonym for `OPTIMISTIC_FORCE_INCREMENT`.
- `NONE`: No locking is performed.

Entities can also be locked at the time when entity state gets loaded from the datastore. This is achieved by supplying a lock mode to the respective versions of `find` and `refresh` methods. If an entity state is to be loaded by a query, a lock mode can be passed to the `Query.setLockMode` and `TypedQuery.setLockMode` methods.

```
public LockModeType getLockMode(Object entity);
```

Returns the lock mode currently held by the given entity.

### Note

- OpenJPA differentiates between `PESSIMISTIC_READ` and `PESSIMISTIC_WRITE` lock modes only with DB2 databases. While running with other databases, there is no distinction between these two modes because `PESSIMISTIC_READ` lock mode is upgraded to `PESSIMISTIC_WRITE`.
- OpenJPA has additional APIs for controlling entity locking. See [Section 9.3, “Object Locking” \[338\]](#) in the Reference Guide for details.

## 8.8. Retrieving Properties Information

There are two sets of properties that may be specified: those that are specific to OpenJPA and those that have been defined by the JPA specification. In some cases, two properties may be equivalent, but have different keys. For example, `openjpa.LockTimeout` and `javax.persistence.lock.timeout` are two different keys for the same property.

There are two methods that can be used to retrieve information related to properties:

```
public Map<String,Object> getProperties();
public Set<String> getSupportedProperties();
```

- `getProperties` - Provides a list of current properties. If a property has more than one key, the key that will be returned is the one that was used when the property was set. If the property was not explicitly set, the key defined by the JPA specification will be returned with the default value.
- `getSupportedProperties` - Returns a set of supported property keys. This includes keys defined by the JPA specification as well as keys specific to OpenJPA. If a property has more than one key, all possible keys will be returned.

### Note

The `getSupportedProperties` method is an OpenJPA extension to the JPA specification.

## 8.9. Closing

```
public boolean isOpen();
public void close();
```

When an `EntityManager` is no longer needed, you should call its `close` method. Closing an `EntityManager` releases any resources it is using. The persistence context ends, and the entities managed by the `EntityManager` become detached. Any Query instances the `EntityManager` created become invalid. Calling any method other than `isOpen` on a closed `EntityManager` results in an `IllegalStateException`. You cannot close a `EntityManager` that is in the middle of a transaction.

If you are in a managed environment using injected entity managers, you should not close them.

---

# Chapter 9. Transaction

Transactions are critical to maintaining data integrity. They are used to group operations into units of work that act in an all-or-nothing fashion. Transactions have the following qualities:

- *Atomicity*. Atomicity refers to the all-or-nothing property of transactions. Either every data update in the transaction completes successfully, or they all fail, leaving the datastore in its original state. A transaction cannot be only partially successful.
- *Consistency*. Each transaction takes the datastore from one consistent state to another consistent state.
- *Isolation*. Transactions are isolated from each other. When you are reading persistent data in one transaction, you cannot "see" the changes that are being made to that data in other transactions. Similarly, the updates you make in one transaction cannot conflict with updates made in concurrent transactions. The form of conflict resolution employed depends on whether you are using pessimistic or optimistic transactions. Both types are described later in this chapter.
- *Durability*. The effects of successful transactions are durable; the updates made to persistent data last for the lifetime of the datastore.

Together, these qualities are called the ACID properties of transactions. To understand why these properties are so important to maintaining data integrity, consider the following example:

Suppose you create an application to manage bank accounts. The application includes a method to transfer funds from one user to another, and it looks something like this:

```
public void transferFunds(User from, User to, double amnt) {
    from.decrementAccount(amnt);
    to.incrementAccount(amnt);
}
```

Now suppose that user Alice wants to transfer 100 dollars to user Bob. No problem; you simply invoke your `transferFunds` method, supplying Alice in the `from` parameter, Bob in the `to` parameter, and `100.00` as the `amnt`. The first line of the method is executed, and 100 dollars is subtracted from Alice's account. But then, something goes wrong. An unexpected exception occurs, or the hardware fails, and your method never completes.

You are left with a situation in which the 100 dollars has simply disappeared. Thanks to the first line of your method, it is no longer in Alice's account, and yet it was never transferred to Bob's account either. The datastore is in an inconsistent state.

The importance of transactions should now be clear. If the two lines of the `transferFunds` method had been placed together in a transaction, it would be impossible for only the first line to succeed. Either the funds would be transferred properly or they would not be transferred at all, and an exception would be thrown. Money could never vanish into thin air, and the data store could never get into an inconsistent state.

## 9.1. Transaction Types

---

There are two major types of transactions: pessimistic transactions and optimistic transactions. Each type has both advantages and disadvantages.

Pessimistic transactions generally lock the datastore records they act on, preventing other concurrent transactions from using the same data. This avoids conflicts between transactions, but consumes database resources. Additionally, locking records can result in *deadlock*, a situation in which two transactions are both waiting for the other to release its locks before completing. The results of a deadlock are datastore-dependent; usually one transaction is forcefully rolled back after some specified timeout interval, and an exception is thrown.

This document will often use the term *datastore* transaction in place of *pessimistic* transaction. This is to acknowledge that some datastores do not support pessimistic semantics, and that the exact meaning of a non-optimistic JPA transaction is dependent on the datastore. Most of the time, a datastore transaction is equivalent to a pessimistic transaction.

Optimistic transactions consume less resources than pessimistic/datastore transactions, but only at the expense of reliability. Because optimistic transactions do not lock datastore records, two transactions might change the same persistent information at the same time, and the conflict will not be detected until the second transaction attempts to flush or commit. At this time, the second transaction will realize that another transaction has concurrently modified the same records (usually through a timestamp or versioning system), and will throw an appropriate exception. Note that optimistic transactions still maintain data integrity; they are simply more likely to fail in heavily concurrent situations.

Despite their drawbacks, optimistic transactions are the best choice for most applications. They offer better performance, better scalability, and lower risk of hanging due to deadlock.

### Note

OpenJPA uses optimistic semantics by default, but supports both optimistic and datastore transactions. OpenJPA also offers advanced locking and versioning APIs for fine-grained control over database resource allocation and object versioning. See [Section 9.3, “Object Locking” \[338\]](#) of the Reference Guide for details on locking. [Section 5.2.6, “Version” \[35\]](#) of this document covers standard object versioning, while [Section 7.7, “Additional JPA Mappings” \[315\]](#) of the Reference Guide discusses additional versioning strategies available in OpenJPA.

## 9.2. The EntityTransaction Interface

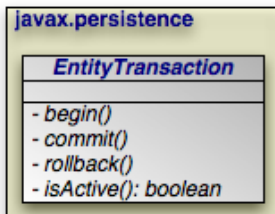

JPA integrates with your container's *managed* transactions, allowing you to use the container's declarative transaction demarcation and its Java Transaction API (JTA) implementation for transaction management. Outside of a container, though, you must demarcate transactions manually through JPA. The `EntityTransaction` interface controls unmanaged transactions in JPA.

```

public void begin();
public void commit();
public void rollback();
  
```

The `begin`, `commit`, and `rollback` methods demarcate transaction boundaries. The methods should be self-explanatory: `begin` starts a transaction, `commit` attempts to commit the transaction's changes to the datastore, and `rollback` aborts the transaction, in which case the datastore is "rolled back" to its previous state. JPA implementations will automatically roll back transactions if any exception is thrown during the commit process.

Unless you are using an extended persistence context, committing or rolling back also ends the persistence context. All managed entities will be detached from the `EntityManager`.

```
public boolean isActive();
```

Finally, the `isActive` method returns `true` if the transaction is in progress (`begin` has been called more recently than `commit` or `rollback`), and `false` otherwise.

### ***Example 9.1. Grouping Operations with Transactions***

```
public void transferFunds(EntityManager em, User from, User to, double amnt) {
    // note: it would be better practice to move the transaction demarcation
    // code out of this method, but for the purposes of example...
    Transaction trans = em.getTransaction();
    trans.begin();
    try
    {
        from.decrementAccount(amnt);
        to.incrementAccount(amnt);
        trans.commit();
    }
    catch (RuntimeException re)
    {
        if (trans.isActive())
            trans.rollback(); // or could attempt to fix error and retry
        throw re;
    }
}
```



---

# Chapter 10. JPA Query

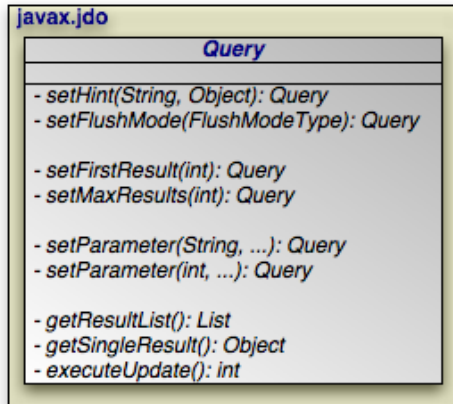

The `javax.persistence.Query` interface is the mechanism for issuing queries in JPA. The primary query language used is the Java Persistence Query Language, or JPQL. JPQL is syntactically very similar to SQL, but is object-oriented rather than table-oriented.

The API for executing JPQL queries will be discussed in [Section 10.1, “JPQL API” \[93\]](#), and a full language reference will be covered in [Section 10.2, “JPQL Language Reference” \[105\]](#).

## 10.1. JPQL API

---

### 10.1.1. Query Basics

---

```
SELECT x FROM Magazine x
```

The preceding is a simple JPQL query for all `Magazine` entities.

```
public Query createQuery(String jpql);
```

The `EntityManager.createQuery` method creates a `Query` instance from a given JPQL string.

```
public List getResultList();
```

Invoking `Query.getResultList` executes the query and returns a `List` containing the matching objects. The following example executes our `Magazine` query above:

```
EntityManager em = ...
Query q = em.createQuery("SELECT x FROM Magazine x");
List<Magazine> results = (List<Magazine>) q.getResultList();
```

A JPQL query has an internal namespace declared in the `from` clause of the query. Arbitrary identifiers are assigned to entities so that they can be referenced elsewhere in the query. In the query example above, the identifier `x` is assigned to the entity `Magazine`.

### Note

The `as` keyword can optionally be used when declaring identifiers in the `from` clause. `SELECT x FROM Magazine x` and `SELECT x FROM Magazine AS x` are synonymous.

Following the `select` clause of the query is the object or objects that the query returns. In the case of the query above, the query's result list will contain instances of the `Magazine` class.

### Note

When selecting entities, you can optionally use the keyword `object`. The clauses `select x` and `SELECT OBJECT(x)` are synonymous.

The optional `where` clause places criteria on matching results. For example:

```
SELECT x FROM Magazine x WHERE x.title = 'JDJ'
```

Keywords in JPQL expressions are case-insensitive, but entity, identifier, and member names are not. For example, the expression above could also be expressed as:

```
select x from Magazine x where x.title = 'JDJ'
```

But it could not be expressed as:

```
SELECT x FROM Magazine x WHERE x.TITLE = 'JDJ'
```

As with the `select` clause, alias names in the `where` clause are resolved to the entity declared in the `from` clause. The query above could be described in English as "for all `Magazine` instances `x`, return a list of every `x` such that `x`'s `title` field is equal to 'JDJ'".

JPQL uses SQL-like syntax for query criteria. The `and` and `or` logical operators chain multiple criteria together:

```
SELECT x FROM Magazine x WHERE x.title = 'JDJ' OR x.title = 'JavaPro'
```

The `=` operator tests for equality. `<>` tests for inequality. JPQL also supports the following arithmetic operators for numeric comparisons: `>`, `>=`, `<`, `<=`. For example:

```
SELECT x FROM Magazine x WHERE x.price > 3.00 AND x.price <= 5.00
```

This query returns all magazines whose price is greater than 3.00 and less than or equal to 5.00.

```
SELECT x FROM Magazine x WHERE x.price <> 3.00
```

This query returns all Magazines whose price is not equal to 3.00.

You can group expressions together using parentheses in order to specify how they are evaluated. This is similar to how parentheses are used in Java. For example:

```
SELECT x FROM Magazine x WHERE (x.price > 3.00 AND x.price <= 5.00) OR x.price < 7.00
```

This expression would match magazines whose price is less than 7.00. Alternately:

```
SELECT x FROM Magazine x WHERE x.price > 3.00 AND (x.price <= 5.00 OR x.price < 7.00)
```

This expression would match magazines whose price is 4.00, 5.00 or 6.00, but not 1.00, 2.00 or 3.00.

JPQL also includes the following conditionals:

- [NOT] BETWEEN: Shorthand for expressing that a value falls between two other values. The following two statements are synonymous:

```
SELECT x FROM Magazine x WHERE x.price >= 3.00 AND x.price <= 5.00
```

```
SELECT x FROM Magazine x WHERE x.price BETWEEN 3.00 AND 5.00
```

- [NOT] LIKE: Performs a string comparison with wildcard support. The special character '\_' in the parameter means to match any single character, and the special character '%' means to match any sequence of characters. The following statement matches title fields "JDJ" and "JavaPro", but not "IT Insider":

```
SELECT x FROM Magazine x WHERE x.title LIKE 'J%'
```

The following statement matches the title field "JDJ" but not "JavaPro":

```
SELECT x FROM Magazine x WHERE x.title LIKE 'J__'
```

- [NOT] IN: Specifies that the member must be equal to one element of the provided list. The following two statements are synonymous:

```
SELECT x FROM Magazine x WHERE x.title IN ('JDJ', 'JavaPro', 'IT Insider')
```

```
SELECT x FROM Magazine x WHERE x.title = 'JDJ' OR x.title = 'JavaPro' OR x.title = 'IT Insider'
```

- **IS [NOT] EMPTY:** Specifies that the collection field holds no elements. For example:

```
SELECT x FROM Magazine x WHERE x.articles is empty
```

This statement will return all magazines whose `articles` member contains no elements.

- **IS [NOT] NULL:** Specifies that the field is equal to null. For example:

```
SELECT x FROM Magazine x WHERE x.publisher is null
```

This statement will return all Magazine instances whose "publisher" field is set to null.

- **NOT:** Negates the contained expression. For example, the following two statements are synonymous:

```
SELECT x FROM Magazine x WHERE NOT(x.price = 10.0)
```

```
SELECT x FROM Magazine x WHERE x.price <> 10.0
```

## 10.1.2. Relation Traversal

Relations between objects can be traversed using Java-like syntax. For example, if the Magazine class has a field named "publisher" of type Company, that relation can be queried as follows:

```
SELECT x FROM Magazine x WHERE x.publisher.name = 'Random House'
```

This query returns all Magazine instances whose `publisher` field is set to a Company instance whose name is "Random House".

Single-valued relation traversal implies that the relation is not null. In SQL terms, this is known as an *inner join*. If you want to also include relations that are null, you can specify:

```
SELECT x FROM Magazine x WHERE x.publisher.name = 'Random House' or x.publisher is null
```

You can also traverse collection fields in queries, but you must declare each traversal in the `from` clause. Consider:

```
SELECT x FROM Magazine x, IN(x.articles) y WHERE y.authorName = 'John Doe'
```

This query says that for each `Magazine x`, traverse the `articles` relation and check each `Article y`, and pass the filter if `y`'s `authorName` field is equal to "John Doe". In short, this query will return all magazines that have any articles written by John Doe.

### Note

The `IN()` syntax can also be expressed with the keywords `inner join`. The statements `SELECT x FROM Magazine x, IN(x.articles) y WHERE y.authorName = 'John Doe'` and `SELECT x FROM Magazine x inner join x.articles y WHERE y.authorName = 'John Doe'` are synonymous.

## 10.1.3. Embeddable Traversal

Similar to relation traversal, nested embeddable objects can be traversed using Java-like syntax. For example, if the `Company` class has a field named "address" of an embeddable type `Address`, and the `Address` has a field named "geocode" of an embeddable type `Geocode`, the `geocode` of a company's address can be queried as follows:

```
SELECT c.address.geocode FROM Company c WHERE c.name = 'Random House'
```

### Note

The `geocode` returned by the above query will not be part of the state of any managed entity. Modifications to these embeddable instances are not allowed.

Traversal into embeddable's state field is also allowed as shown in the following query:

```
SELECT c.address.geocode.latitude FROM Company c WHERE c.name = 'Random House'
```

Embeddable objects may contain single-valued or collection-valued relations. These relations can also be traversed using Java-like syntax. For example, if the `Address` has a relation field named "phoneLists" of an entity type `PhoneNumber`, the following query returns the `PhoneNumber` entities of the `Company` named 'Random House':

```
SELECT p FROM Company c, IN(c.address.phoneLists) p WHERE c.name = 'Random House'
```

## 10.1.4. Fetch Joins

JPQL queries may specify one or more `join fetch` declarations, which allow the query to specify which fields in the returned instances will be pre-fetched.

```
SELECT x FROM Magazine x join fetch x.articles WHERE x.title = 'JDJ'
```

The query above returns `Magazine` instances and guarantees that the `articles` field will already be fetched in the returned instances.

Multiple fields may be specified in separate `join fetch` declarations:

```
SELECT x FROM Magazine x join fetch x.articles join fetch x.authors WHERE x.title = 'JDJ'
```

Notice that in the above query, both `articles` and `authors` are relation property in `Magazine`. JPQL syntax does not allow range variable declared for paths on the right-hand side of `join fetch`. Therefore, if `Article` entity has a relation property of `publishers`, it is not possible to specify a query that returns `Magazine` instances and pre-fetch the `articles` and the `publishers`. The following query will result in syntax error:

```
SELECT x FROM Magazine x join fetch x.articles a join fetch a.publishers p WHERE x.title = 'JDJ'
```

## Note

Specifying the `join fetch` declaration is functionally equivalent to adding the fields to the Query's `FetchConfiguration`. See [Section 5.7, “Fetch Groups” \[290\]](#).

## 10.1.5. JPQL Functions

As well as supporting direct field and relation comparisons, JPQL supports a pre-defined set of functions that you can apply.

- `CONCAT(string1, string2)`: Concatenates two string fields or literals. For example:

```
SELECT x FROM Magazine x WHERE CONCAT(x.title, 's') = 'JDJs'
```

- `SUBSTRING(string, startIndex, [length])`: Returns the part of the `string` argument starting at `startIndex` (1-based) and optionally ending at `length` characters past `startIndex`. If the `length` argument is not specified, the substring from the `startIndex` to the end of the `string` is returned.

```
SELECT x FROM Magazine x WHERE SUBSTRING(x.title, 1, 1) = 'J'
```

- `TRIM([LEADING | TRAILING | BOTH] [character FROM] string)`: Trims the specified character from either the beginning ( `LEADING` ) end ( `TRAILING` ) or both ( `BOTH` ) of the `string` argument. If no trim character is specified, the space character will be trimmed.

```
SELECT x FROM Magazine x WHERE TRIM(BOTH 'J' FROM x.title) = 'D'
```

- `LOWER(string)`: Returns the lower-case of the specified string argument.

```
SELECT x FROM Magazine x WHERE LOWER(x.title) = 'jdj'
```

- `UPPER(string)`: Returns the upper-case of the specified string argument.

```
SELECT x FROM Magazine x WHERE UPPER(x.title) = 'JAVAPRO'
```

- `LENGTH(string)`: Returns the number of characters in the specified string argument.

```
SELECT x FROM Magazine x WHERE LENGTH(x.title) = 3
```

- `LOCATE(searchString, candidateString [, startIndex])`: Returns the first index of `searchString` in `candidateString`. Positions are 1-based. If the string is not found, returns 0.

```
SELECT x FROM Magazine x WHERE LOCATE('D', x.title) = 2
```

- `ABS(number)`: Returns the absolute value of the argument.

```
SELECT x FROM Magazine x WHERE ABS(x.price) >= 5.00
```

- `SQRT(number)`: Returns the square root of the argument.

```
SELECT x FROM Magazine x WHERE SQRT(x.price) >= 1.00
```

- `MOD(number, divisor)`: Returns the modulo of `number` and `divisor`.

```
SELECT x FROM Magazine x WHERE MOD(x.price, 10) = 0
```

- `INDEX(identification_variable)`: Returns an integer value corresponding to the position of its argument in an ordered list. The `INDEX` function can only be applied to identification variables denoting types for which an order column has been specified.

In the following example, `studentWaitlist` is a list of students for which an order column has been specified, the query returns the name of the first student on the waiting list of the course named 'Calculus':

```
SELECT w.name FROM Course c JOIN c.studentWaitlist w WHERE c.name = 'Calculus' AND INDEX(w) = 0
```

- `CURRENT_DATE`: Returns the current date.
- `CURRENT_TIME`: Returns the current time.
- `CURRENT_TIMESTAMP`: Returns the current timestamp.

## 10.1.6. Polymorphic Queries

All JPQL queries are polymorphic, which means the `from` clause of a query includes not only instances of the specific entity class to which it refers, but all subclasses of that class as well. The instances returned by a query include instances of the subclasses that satisfy the query conditions. For example, the following query may return instances of `Magazine`, as well as `Tabloid` and `Digest` instances, where `Tabloid` and `Digest` are `Magazine` subclasses.

```
SELECT x FROM Magazine x WHERE x.price < 5
```

Non-polymorphic queries or queries whose polymorphism is restricted can be specified using entity type expressions (see [Section 10.2.6.4, “Entity Type Expressions” \[128\]](#)) in the `WHERE` clause to restrict the domain of the query. For example, the following query returns instances of `Digest`:

```
SELECT x FROM Magazine WHERE TYPE(x) = Digest
```

## 10.1.7. Query Parameters

JPQL provides support for parameterized queries. Either named parameters or positional parameters may be specified in the query string. Parameters allow you to re-use query templates where only the input parameters vary. A single query can declare either named parameters or positional parameters, but is not allowed to declare both named and positional parameters.

```
public Query setParameter (int pos, Object value);
```

Specify positional parameters in your JPQL string using an integer prefixed by a question mark. You can then populate the `Query` object with positional parameter values via calls to the `setParameter` method above. The method returns the `Query` instance for optional method chaining.

```
EntityManager em = ...
Query q = em.createQuery("SELECT x FROM Magazine x WHERE x.title = ?1 and x.price > ?2");
q.setParameter(1, "JDJ").setParameter(2, 5.0);
List<Magazine> results = (List<Magazine>) q.getResultList();
```

This code will substitute `JDJ` for the `?1` parameter and `5.0` for the `?2` parameter, then execute the query with those values.

```
public Query setParameter(String name, Object value);
```

Named parameters are denoted by prefixing an arbitrary name with a colon in your JPQL string. You can then populate the `Query` object with parameter values using the method above. Like the positional parameter method, this method returns the `Query` instance for optional method chaining.



```
EntityManager em = ...
Query q = em.createQuery("SELECT x FROM Magazine x WHERE x.title = :titleParam and x.price > :priceParam");
q.setParameter("titleParam", "JDJ").setParameter("priceParam", 5.0);
List<Magazine> results = (List<Magazine>) q.getResultList();
```

This code substitutes JDJ for the `:titleParam` parameter and 5.0 for the `:priceParam` parameter, then executes the query with those values.

All input parameters must be single-valued, except in IN expressions (see [Section 10.2.5.9, “JPQL In Expressions” \[122\]](#)), which support the use of collection-valued input parameters.

## 10.1.8. Query Hints

JPQL provides support for hints which are name/value pairs used to control locking and optimization keywords in SQL. The following example shows how to use the JPA hint API to set the `ReadLockMode` and `ResultCount` in the OpenJPA fetch plan. This will result in a database-specific SQL keyword (usually `FOR UPDATE`) to be emitted into the SQL provided that a pessimistic `LockManager` is being used. Additionally, if a DB2 database is being used, the `OPTIMIZE FOR 2 ROWS` clause will also be emitted.

### *Example 10.1. Query Hints*

```
...
Query q = em.createQuery("select m from Magazine m where ... ");
q.setHint("openjpa.hint.OptimizeResultCount", new Integer(2));
q.setHint("openjpa.FetchPlan.ReadLockMode", "WRITE");
List r = q.getResultList();
...
```

Hints which can not be processed by a particular database or are unknown to OpenJPA are ignored. Hints known to OpenJPA but supplied with an incompatible value will result in an `IllegalArgumentException` being thrown.

### 10.1.8.1. Locking Hints

To avoid deadlock and optimistic update exceptions among multiple updaters, use a pessimistic `LockManager`, specified in the persistence unit definition, and use a hint name of `openjpa.FetchPlan.ReadLockMode` on queries for entities that must be locked for serialization. The value of `ReadLockMode` can be either `READ` or `WRITE`. This results in a database-specific locking keyword (usually `FOR UPDATE`) to be emitted into the SQL.

Using a `ReadLockMode` hint with JPA optimistic locking (i.e. specifying `LockManager = "version"`) will result in the entity version field either being reread at end of transaction in the case of a value of `READ` or the version field updated at end of transaction in the case of `WRITE`. You must define a version field in the entity mapping when using a version `LockManager` and using `ReadLockMode`.

**Table 10.1. Interaction of `ReadLockMode` hint and `LockManager`**

<b>ReadLockMode</b>	<b>LockManager=pessimistic</b>	<b>LockManager=version</b>
READ	SQL with FOR UPDATE	SQL without FOR UPDATE; reread version field at the end of transaction and check for no change.
WRITE	SQL with FOR UPDATE	SQL without FOR UPDATE;

ReadLockMode	LockManager=pessimistic	LockManager=version
		force update version field at the end of transaction
not specified	SQL without FOR UPDATE	SQL without FOR UPDATE

### 10.1.8.2. Lock Timeout Hint

To specify a lock timeout hint in milliseconds to those databases that support it, specify a hint name of "openjpa.LockTimeout" or "javax.persistence.lock.timeout" with an integer value greater than zero, or zero for no timeout which is the default behavior.

### 10.1.8.3. Query Timeout Hint

To specify a query timeout hint in milliseconds to those database drivers that support it, specify a hint name of "javax.persistence.query.timeout" with an integer value greater than zero, or zero for no timeout which is the default behavior.

### 10.1.8.4. Result Set Size Hint

To specify a result set size hint to those databases that support it, specify a hint name of "openjpa.hint.OptimizeResultCount" with an integer value greater than zero. This causes the SQL keyword OPTIMIZE FOR to be generated.

### 10.1.8.5. Isolation Level Hint

To specify an isolation level, specify a hint name of "openjpa.FetchPlan.Isolation". The value will be used to specify isolation level using the SQL WITH <isolation> clause for those databases that support it. This hint only works in conjunction with the ReadLockMode hint.

### 10.1.8.6. Other Fetchplan Hints

Any property of an OpenJPA FetchPlan can be changed using a hint by using a name of the form "openjpa.FetchPlan."<property name>. Valid property names include: MaxFetchDepth, FetchBatchSize, LockTimeOut, EagerFetchMode, SubclassFetchMode and Isolation.

### 10.1.8.7. Database-Specific Hints

The hint names "openjpa.hint.MySQLSelectHint" and "openjpa.hint.OracleSelectHint" can be used to specify a string value of a query hint that will be inserted into SQL for MySQL and Oracle databases. See [Section 2.19.1, “Using Query Hints with MySQL” \[400\]](#) and [Section 2.20.1, “Using Query Hints with Oracle” \[401\]](#) for examples.

### 10.1.8.8. Named Query Hints

Hints can also be included as part of a NamedQuery definition.

#### *Example 10.2. Named Query using Hints*

```

...
@NamedQuery(name="magsOverPrice",
    query="SELECT x FROM Magazine x WHERE x.price > ?1",
    hints={
        @QueryHint(name="openjpa.hint.OptimizeResultCount", value="2"),
        @QueryHint(name="openjpa.FetchPlan.ReadLockMode", value="WRITE")
    }
)
...

```

### 10.1.8.9. Handling of Multiple Similar Query Hints

When similar hints in different prefix scopes are specified in a query, the following prefix precedence order is used to select the effective hint:

- javax.persistence.\*
- openjpa.FetchPlan.\*
- openjpa.jdbc.\*
- openjpa.\*

#### *Example 10.3. Setting Multiple Similar Query Hints*

```
...
Query q = em.createQuery(...);
q.setHint("openjpa.FetchPlan.LockTimeout", 1000);
q.setHint("javax.persistence.lock.timeout", 2000);
q.setHint("openjpa.LockTimeout", 3000);
// Lock time out of 2000 ms is in effect for query q
...
```

### 10.1.9. Ordering

JPQL queries may optionally contain an `order by` clause which specifies one or more fields to order by when returning query results. You may follow the `order by field` clause with the `asc` or `desc` keywords, which indicate that ordering should be ascending or descending, respectively. If the direction is omitted, ordering is ascending by default.

```
SELECT x FROM Magazine x order by x.title asc, x.price desc
```

The query above returns `Magazine` instances sorted by their title in ascending order. In cases where the titles of two or more magazines are the same, those instances will be sorted by price in descending order.

### 10.1.10. Aggregates

JPQL queries can select aggregate data as well as objects. JPQL includes the `min`, `max`, `avg`, and `count` aggregates. These functions can be used for reporting and summary queries.

The following query will return the average of all the prices of all the magazines:

```
EntityManager em = ...
Query q = em.createQuery("SELECT AVG(x.price) FROM Magazine x");
Number result = (Number) q.getSingleResult();
```

The following query will return the highest price of all the magazines titled "JDJ":

```
EntityManager em = ...
Query q = em.createQuery("SELECT MAX(x.price) FROM Magazine x WHERE x.title = 'JDJ'");
```

```
Number result = (Number) q.getSingleResult();
```

## 10.1.11. Named Queries

Query templates can be statically declared using the `NamedQuery` and `NamedQueries` annotations. For example:

```
@Entity
@NamedQueries({
    @NamedQuery(name="magsOverPrice",
        query="SELECT x FROM Magazine x WHERE x.price > ?1"),
    @NamedQuery(name="magsByTitle",
        query="SELECT x FROM Magazine x WHERE x.title = :titleParam")
})
public class Magazine {
    ...
}
```

These declarations will define two named queries called `magsOverPrice` and `magsByTitle`.

```
public Query createNamedQuery(String name);
```

You retrieve named queries with the above `EntityManager` method. For example:

```
EntityManager em = ...
Query q = em.createNamedQuery("magsOverPrice");
q.setParameter(1, 5.0f);
List<Magazine> results = (List<Magazine>) q.getResultList();
```

```
EntityManager em = ...
Query q = em.createNamedQuery("magsByTitle");
q.setParameter("titleParam", "JDJ");
List<Magazine> results = (List<Magazine>) q.getResultList();
```

## 10.1.12. Delete By Query

Queries are useful not only for finding objects, but for efficiently deleting them as well. For example, you might delete all records created before a certain date. Rather than bring these objects into memory and delete them individually, JPA allows you to perform a single bulk delete based on JPQL criteria.

Delete by query uses the same JPQL syntax as normal queries, with one exception: begin your query string with the `delete` keyword instead of the `select` keyword. To then execute the delete, you call the following `Query` method:

```
public int executeUpdate();
```

This method returns the number of objects deleted. The following example deletes all subscriptions whose expiration date has passed.

**Example 10.4. Delete by Query**

```
Query q = em.createQuery("DELETE FROM Subscription s WHERE s.subscriptionDate < :today");
q.setParameter("today", new Date());
int deleted = q.executeUpdate();
```

## 10.1.13. Update By Query

Similar to bulk deletes, it is sometimes necessary to perform updates against a large number of queries in a single operation, without having to bring all the instances down to the client. Rather than bring these objects into memory and modifying them individually, JPA allows you to perform a single bulk update based on JPQL criteria.

Update by query uses the same JPQL syntax as normal queries, except that the query string begins with the `update` keyword instead of `select`. To execute the update, you call the following `Query` method:

```
public int executeUpdate();
```

This method returns the number of objects updated. The following example updates all subscriptions whose expiration date has passed to have the "paid" field set to true..

**Example 10.5. Update by Query**

```
Query q = em.createQuery("UPDATE Subscription s SET s.paid = :paid WHERE s.subscriptionDate < :today");
q.setParameter("today", new Date());
q.setParameter("paid", true);
int updated = q.executeUpdate();
```

## 10.2. JPQL Language Reference

The Java Persistence Query Language (JPQL) is used to define searches against persistent entities independent of the mechanism used to store those entities. As such, JPQL is "portable", and not constrained to any particular data store. The Java Persistence query language is an extension of the Enterprise JavaBeans query language, EJB QL, adding operations such as bulk deletes and updates, join operations, aggregates, projections, and subqueries. Furthermore, JPQL queries can be declared statically in metadata, or can be dynamically built in code. This chapter provides the full definition of the language.

### Note

Much of this section is paraphrased or taken directly from Chapter 4 of the JSR 317 Java Persistence API Specification.

### 10.2.1. JPQL Statement Types

A JPQL statement may be either a `SELECT` statement, an `UPDATE` statement, or a `DELETE` statement. This chapter refers to all such statements as "queries". Where it is important to distinguish among statement types, the specific statement type is referenced. In BNF syntax, a query language statement is defined as:

- `QL_statement ::= select_statement | update_statement | delete_statement`

The complete BNF for JPQL is defined in **Section 10.2.13, “JPQL BNF”** [137]. Any JPQL statement may be constructed dynamically or may be statically defined in a metadata annotation or XML descriptor element. All statement types may have parameters, as discussed in **Section 10.2.5.4, “JPQL Input Parameters”** [119].

### 10.2.1.1. JPQL Select Statement

---

A select statement is a string which consists of the following clauses:

- a `SELECT` clause, which determines the type of the objects or values to be selected.
- a `FROM` clause, which provides declarations that designate the domain to which the expressions specified in the other clauses of the query apply.
- an optional `WHERE` clause, which may be used to restrict the results that are returned by the query.
- an optional `GROUP BY` clause, which allows query results to be aggregated in terms of groups.
- an optional `HAVING` clause, which allows filtering over aggregated groups.
- an optional `ORDER BY` clause, which may be used to order the results that are returned by the query.

In BNF syntax, a select statement is defined as:

- `select_statement ::= select_clause from_clause [where_clause] [groupby_clause] [having_clause] [orderby_clause]`

A select statement must always have a `SELECT` and a `FROM` clause. The square brackets `[]` indicate that the other clauses are optional.

### 10.2.1.2. JPQL Update and Delete Statements

---

Update and delete statements provide bulk operations over sets of entities. In BNF syntax, these operations are defined as:

- `update_statement ::= update_clause [where_clause]`
- `delete_statement ::= delete_clause [where_clause]`

The update and delete clauses determine the type of the entities to be updated or deleted. The `WHERE` clause may be used to restrict the scope of the update or delete operation. Update and delete statements are described further in **Section 10.2.10, “JPQL Bulk Update and Delete”** [136].

## 10.2.2. JPQL Abstract Schema Types and Query Domains

---

The Java Persistence query language is a typed language, and every expression has a type. The type of an expression is derived from the structure of the expression, the abstract schema types of the identification variable declarations, the types to which the persistent fields and relationships evaluate, and the types of literals.

The abstract schema type of an entity or embeddable is derived from the entity class and the metadata information provided by Java language annotations or in the XML descriptor.

Informally, the abstract schema type of an entity or embeddable can be characterized as follows:

- For every persistent field or get accessor method (for a persistent property) of the entity class, there is a field ("state-field") whose abstract schema type corresponds to that of the field or the result type of the accessor method.
- For every persistent relationship field or get accessor method (for a persistent relationship property) of the entity class, there is a field ("association-field") whose type is the abstract schema type of the related entity (or, if the relationship is a one-to-many or many-to-many, a collection of such).

Abstract schema types are specific to the query language data model. The persistence provider is not required to implement or otherwise materialize an abstract schema type.

The domain of a query consists of the abstract schema types of all entities and embeddables that are defined in the same persistence unit.

The domain of a query may be restricted by the `navigability` of the relationships of the entity and associated embeddable classes on which it is based. The association-fields of an entity's or embeddable's abstract schema type determine navigability. Using the association fields and their values, a query can select related entities and use their abstract schema types in the query.

### 10.2.2.1. JPQL Entity Naming

Entities are designated in query strings by their entity names. The entity name is defined by the name element of the Entity annotation (or the entity-name XML descriptor element), and defaults to the unqualified name of the entity class. Entity names are scoped within the persistence unit and must be unique within the persistence unit.

### 10.2.2.2. JPQL Schema Example

This example assumes that the application developer provides several entity classes, representing magazines, publishers, authors, and articles. The abstract schema types for these entities are `Magazine`, `Publisher`, `Author`, and `Article`.

Several Entities with Abstract Persistence Schemas Defined in the Same Persistence Unit. The entity `Publisher` has a one-to-many relationships with `Magazine`. There is also a one-to-many relationship between `Magazine` and `Article`. The entity `Article` is related to `Author` in a one-to-one relationship.

Queries to select magazines can be defined by navigating over the association-fields and state-fields defined by `Magazine` and `Author`. A query to find all magazines that have unpublished articles is as follows:

```
SELECT DISTINCT mag FROM Magazine AS mag JOIN mag.articles AS art WHERE art.published = FALSE
```

This query navigates over the association-field `authors` of the abstract schema type `Magazine` to find articles, and uses the state-field `published` of `Article` to select those magazines that have at least one article that is not published. Although predefined reserved identifiers, such as `DISTINCT`, `FROM`, `AS`, `JOIN`, `WHERE`, and `FALSE` appear in upper case in this example, predefined reserved identifiers are case insensitive.

The `SELECT` clause of this example designates the return type of this query to be of type `Magazine`.

Because the same persistence unit defines the abstract persistence schemas of the related entities, the developer can also specify a query over articles that utilizes the abstract schema type for products, and hence the state-fields and association-fields of both the abstract schema types `Magazine` and `Author`. For example, if the abstract schema type `Author` has a state-field named `firstName`, a query over articles can be specified using this state-field. Such a query might be to find all magazines that have articles authored by someone with the first name "John".

```
SELECT DISTINCT mag FROM Magazine mag JOIN mag.articles art JOIN art.author auth WHERE auth.firstName = 'John'
```

Because `Magazine` is related to `Author` by means of the relationships between `Magazine` and `Article` and between `Article` and `Author`, navigation using the association-fields `authors` and `product` is used to express the query. This query is specified by using the abstract schema name `Magazine`, which designates the abstract schema type over which the query ranges. The basis for the navigation is provided by the association-fields `authors` and `product` of the abstract schema types `Magazine` and `Article` respectively.

## 10.2.3. JPQL FROM Clause and Navigational Declarations

The `FROM` clause of a query defines the domain of the query by declaring identification variables. An identification variable is an identifier declared in the `FROM` clause of a query. The domain of the query may be constrained by path expressions (See section [Section 10.2.3.4, “JPQL Path Expressions” \[112\]](#)).

Identification variables designate instances of a particular entity abstract schema type. The `FROM` clause can contain multiple identification variable declarations separated by a comma (,).

- `from_clause ::= FROM identification_variable_declaration { , { identification_variable_declaration | collection_member_declaration } }*`
- `identification_variable_declaration ::= range_variable_declaration { join | fetch_join }*`
- `range_variable_declaration ::= abstract_schema_name [AS] identification_variable`
- `join ::= join_spec join_association_path_expression [AS] identification_variable`
- `fetch_join ::= join_spec FETCH join_association_path_expression`
- `join_association_path_expression ::= join_collection_valued_path_expression | join_single_valued_association_path_expression`
- `join_collection_valued_path_expression ::= identification_variable. {single_valued_embeddable_object_field.}*collection_valued_field`
- `join_single_valued_path_expression ::= identification_variable. {single_valued_embeddable_object_field.}*single_valued_object_field`
- `join_spec ::= [ LEFT [OUTER] | INNER ] JOIN`
- `collection_member_declaration ::= IN (collection_valued_path_expression) [AS] identification_variable`

The following subsections discuss the constructs used in the `FROM` clause.

### 10.2.3.1. JPQL FROM Identifiers

An identifier is a character sequence of unlimited length. The character sequence must begin with a Java identifier start character, and all other characters must be Java identifier part characters. An identifier start character is any character for which the method `Character.isJavaIdentifierStart` returns `true`. This includes the underscore (`_`) character and the dollar sign (`$`) character. An identifier part character is any character for which the method `Character.isJavaIdentifierPart` returns `true`. The question mark (`?`) character is reserved for use by the Java Persistence query language. The following are reserved identifiers:

- ABS
- ALL
- AND
- ANY
- AS
- ASC
- AVG



- BETWEEN
- BOTH
- BY
- CASE
- CLASS
- COALESCE
- CONCAT
- COUNT
- CURRENT\_DATE
- CURRENT\_TIME
- CURRENT\_TIMESTAMP
- DELETE
- DESC
- DISTINCT
- ELSE
- EMPTY
- END
- ENTRY
- ESCAPE
- EXISTS
- FALSE
- FETCH
- FROM
- GROUP
- HAVING
- IN
- INDEX
- INNER
- IS
- JOIN

- KEY
- LEADING
- LEFT
- LENGTH
- LIKE
- LOCATE
- LOWER
- MAX
- MEMBER
- MIN
- MOD
- NEW
- NOT
- NULL
- NULLIF
- OBJECT
- OF
- OR
- ORDER
- OUTER
- SELECT
- SET
- SIZE
- SOME
- SQRT
- SIBSTRING
- SUM
- THEN
- TRAILING
- TRIM
- TRUE

- TYPE
- UPDATE
- UPPER
- VALUE
- WHEN
- WHERE
- CHARACTER\_LENGTH
- CHAR\_LENGTH
- BIT\_LENGTH
- POSITION
- UNKNOWN

Reserved identifiers are case insensitive. Reserved identifiers must not be used as identification variables or result variables.

### Note

It is recommended that other SQL reserved words also not be used as identification variables in queries because they may be used as reserved identifiers in future releases of the specification.

### Note

BIT\_LENGTH, CHAR\_LENGTH, CHARACTER\_LENGTH, POSITION, and UNKNOWN are not currently used: they are reserved for future use.

## 10.2.3.2. JPQL Identification Variables

An identification variable is a valid identifier declared in the `FROM` clause of a query.

All identification variables must be declared in the `FROM` clause. Identification variables cannot be declared in other clauses.

An identification variable must not be a reserved identifier or have the same name as any entity in the same persistence unit.

Identification variables are case insensitive.

An identification variable evaluates to a value of the type of the expression used in declaring the variable. For example, consider the previous query:

```
SELECT DISTINCT mag FROM Magazine mag JOIN mag.articles art JOIN art.author auth WHERE auth.firstName = 'John'
```

In the `FROM` clause declaration `mag.articles art`, the identification variable `art` evaluates to any `Article` value directly reachable from `Magazine`. The association-field `articles` is a collection of instances of the abstract schema type `Article` and the identification variable `art` refers to an element of this collection. The type of `auth` is the abstract schema type of `Author`.

An identification variable can range over an entity, embeddable, or basic abstract schema type. An identification variable designates an instance of an entity abstract schema type or an element of a collection of entity abstract schema type instances.

Note that for identification variables referring to an instance of an association or collection represented as a `java.util.Map`, the identification variable is of the abstract schema type of the map value.

An identification variable always designates a reference to a single value. It is declared in one of three ways: in a range variable declaration, in a join clause, or in a collection member declaration. The identification variable declarations are evaluated from left to right in the `FROM` clause, and an identification variable declaration can use the result of a preceding identification variable declaration of the query string.

All identification variables used in the `SELECT`, `WHERE`, `ORDER BY`, `GROUP BY`, or `HAVING` clause of a `SELECT` or `DELETE` statement must be declared in the `FROM` clause. The identification variables used in the `WHERE` clause of an `UPDATE` statement must be declared in the `UPDATE` clause.

Identification variables are existentially quantified in these clauses. This means that an identification variable represents a member of a collection or an instance of an entity's abstract schema type. An identification variable never designates a collection in its entirety.

An identification variable is scoped to the query (or subquery) in which it is defined and is also visible to any subqueries within that query scope that do not define an identification variable of the same name.

### 10.2.3.3. JPQL Range Declarations

The syntax for declaring an identification variable as a range variable is similar to that of SQL; optionally, it uses the `AS` keyword. A range variable designates an entity abstract schema type.

#### Note

A range variable must not designate an embeddable class abstract schema type.

- `range_variable_declaration ::= entity_name [AS] identification_variable`

Range variable declarations allow the developer to designate a "root" for objects which may not be reachable by navigation.

In order to select values by comparing more than one instance of an entity abstract schema type, more than one identification variable ranging over the abstract schema type is needed in the `FROM` clause.

The following query returns magazines whose price is greater than the price of magazines published by "Adventure" publishers. This example illustrates the use of two different identification variables in the `FROM` clause, both of the abstract schema type `Magazine`. The `SELECT` clause of this query determines that it is the magazines with prices greater than those of "Adventure" publisher's that are returned.

```
SELECT DISTINCT mag1 FROM Magazine mag1, Magazine mag2
WHERE mag1.price > mag2.price AND mag2.publisher.name = 'Adventure'
```

### 10.2.3.4. JPQL Path Expressions

An identification variable followed by the navigation operator (`.`) and a state-field or association-field is a path expression. The type of the path expression is the type computed as the result of navigation; that is, the type of the state-field or association-field to which the expression navigates.

An identification variable qualified by the `KEY`, `VALUE`, or `ENTRY` operator is a path expression. The `KEY`, `VALUE`, and `ENTRY` operators may only be applied to identification variables that correspond to map-valued associations or map-valued element

collections. The type of the path expression is the type computed as the result of the operation; that is, the abstract schema type of the field that is the value of the `KEY`, `VALUE`, or `ENTRY` operator (the map key, map value, or map entry respectively).

### Note

Note that use of `VALUE` is optional, as an identification variable referring to an association of type `java.util.Map` is of the abstract schema type of the map value.

The syntax for qualified identification variables is as follows.

- qualified\_identification\_variable ::= `KEY(identification_variable) | VALUE(identification_variable) | ENTRY(identification_variable)`

A path expression using the `KEY` or `VALUE` operator may be further composed. A path expression using the `ENTRY` operator is terminal. It cannot be further composed and can only appear in the `SELECT` list of a query.

In the following query, `photos` is a map from `photo` label to filename.

```
SELECT i.name, VALUE(p)
FROM Item i JOIN i.photos p
WHERE KEY(p) LIKE 'egret'
```

In the above query the identification variable `p` designates an abstract schema type corresponding to the map value. The results of `VALUE(p)` and `KEY(p)` are the map value and the map key associated with `p`, respectively. The following query is equivalent:

```
SELECT i.name, p
FROM Item i JOIN i.photos p
WHERE KEY(p) LIKE 'egret'
```

Depending on navigability, a path expression that leads to a association-field or to a field whose type is an embeddable class may be further composed. Path expressions can be composed from other path expressions if the original path expression evaluates to a single-valued type (not a collection) corresponding to a association-field.

In the following example, `contactInfo` denotes an embeddable class consisting of an address and set of phones. Phone is an entity.

```
SELECT p.vendor
FROM Employee e JOIN e.contactInfo.phones p
WHERE e.contactInfo.address.zipcode = '95054'
```

Path expression navigability is composed using "inner join" semantics. That is, if the value of a non-terminal association-field in the path expression is null, the path is considered to have no value, and does not participate in the determination of the result.

The following query is equivalent to the query above:

```
SELECT p.vendor
FROM Employee e JOIN e.contactInfo c JOIN c.phones p
WHERE e.contactInfo.address.zipcode = '95054'
```

The syntax for single-valued path expressions and collection valued path expressions is as follows:

- `single_valued_path_expression ::= qualified_identification_variable | state_field_path_expression | single_valued_object_path_expression`
- `state_field_path_expression ::= general_identification_variable.{single_valued_object_field.*}state_field`
- `single_valued_object_path_expression ::= general_identification_variable.{single_valued_object_field.*}single_valued_object_field`
- `collection_valued_path_expression ::= general_identification_variable.{single_valued_object_field.*}collection_valued_field`

A `single_valued_object_field` is designated by the name of an association-field in a one-to-one or many-to-one relationship or a field of embeddable class type. The type of a `single_valued_object_field` is the abstract schema type of the related entity or embeddable class.

A `state_field` is designated by the name of an entity or embeddable class state field that corresponds to a basic type.

A `collection_valued_field` is designated by the name of an association-field in a one-to-many or a many-to-many relationship or by the name of an element collection field. The type of a `collection_valued_field` is a collection of values of the abstract schema type of the related entity or element type.

An identification variable used in a `single_valued_object_path_expression` or in a `collection_valued_path_expression` may be an unqualified identification variable or an identification variable to which the `KEY` or `VALUE` function has been applied.

- `general_identification_variable ::= identification_variable | KEY(identification_variable) | VALUE(identification_variable)`

It is syntactically illegal to compose a path expression from a path expression that evaluates to a collection. For example, if `mag` designates `Magazine`, the path expression `mag.articles.author` is illegal since navigation to authors results in a collection. This case should produce an error when the query string is verified. To handle such a navigation, an identification variable must be declared in the `FROM` clause to range over the elements of the `articles` collection. Another path expression must be used to navigate over each such element in the `WHERE` clause of the query, as in the following query which returns all authors that have any articles in any magazines:

```
SELECT DISTINCT art.author FROM Magazine AS mag, IN(mag.articles) art
```

It is illegal to use a `collection_valued_path_expression` other than in the `FROM` clause of a query except in an `empty_collection_comparison_expression`, in a `collection_member_expression`, or as an argument to the `SIZE` operator. See [Section 10.2.5.12, “JPQL Empty Collection Comparison Expressions” \[123\]](#), [Section 10.2.5.13, “JPQL Collection Member Expressions” \[124\]](#), and [Section 10.2.6.2.2, “JPQL Arithmetic Functions” \[127\]](#).

### 10.2.3.5. JPQL Joins

An inner join may be implicitly specified by the use of a cartesian product in the `FROM` clause and a join condition in the `WHERE` clause. In the absence of a join condition, this reduces to the cartesian product.

The main use case for this generalized style of join is when a join condition does not involve a foreign key relationship that is mapped to an entity relationship, for example:

```
SELECT c FROM Customer c, Employee e WHERE c.hatsize = e.shoesize
```

In general, use of this style of inner join (also referred to as theta-join) is less typical than explicitly defined joins over relationships.

The syntax for explicit join operations is as follows:

- `join ::= join_spec join_association_path_expression [AS] identification_variable`
- `fetch_join ::= join_spec FETCH join_association_path_expression`
- `join_association_path_expression ::= join_collection_valued_path_expression | join_single_valued_path_expression`
- `join_collection_valued_path_expression ::= identification_variable.  
{single_valued_embeddable_object_field.}*collection_valued_field`
- `join_single_valued_path_expression ::= identification_variable.  
{single_valued_embeddable_object_field.}*single_valued_object_field`
- `join_spec ::= [ LEFT [OUTER] | INNER ] JOIN`

The inner and outer join operation types described in [Section 10.2.3.5.1, “JPQL Inner Joins \(Relationship Joins\)” \[115\]](#) and [Section 10.2.3.5.2, “JPQL Outer Joins” \[116\]](#) are supported.

### 10.2.3.5.1. JPQL Inner Joins (Relationship Joins)

The syntax for the inner join operation is

- `[ INNER ] JOIN join_association_path_expression [AS] identification_variable`

For example, the query below joins over the relationship between publishers and magazines. This type of join typically equates to a join over a foreign key relationship in the database.

```
SELECT pub FROM Publisher pub JOIN pub.magazines mag WHERE pub.revenue > 1000000
```

The keyword `INNER` may optionally be used:

```
SELECT pub FROM Publisher pub INNER JOIN pub.magazines mag WHERE pub.revenue > 1000000
```

This is equivalent to the following query using the earlier `IN` construct. It selects those publishers with revenue of over 1 million for which at least one magazine exists:

```
SELECT OBJECT(pub) FROM Publisher pub, IN(pub.magazines) mag WHERE pub.revenue > 1000000
```

The query below joins over `Employee`, `ContactInfo` and `Phone`. `ContactInfo` is an embeddable class that consists of an address and set of phones. `Phone` is an entity.

```
SELECT p.vendor
FROM Employee e JOIN e.contactInfo c JOIN c.phones p
WHERE c.address.zipcode = '95054'
```

### 10.2.3.5.2. JPQL Outer Joins

`LEFT JOIN` and `LEFT OUTER JOIN` are synonymous. They enable the retrieval of a set of entities where matching values in the join condition may be absent. The syntax for a left outer join is:

- `LEFT [OUTER] JOIN join_association_path_expression [AS] identification_variable`

For example:

```
SELECT pub FROM Publisher pub LEFT JOIN pub.magazines mag WHERE pub.revenue > 1000000
```

The keyword `OUTER` may optionally be used:

```
SELECT pub FROM Publisher pub LEFT OUTER JOIN pub.magazines mags WHERE pub.revenue > 1000000
```

An important use case for `LEFT JOIN` is in enabling the prefetching of related data items as a side effect of a query. This is accomplished by specifying the `LEFT JOIN` as a `FETCH JOIN`.

### 10.2.3.5.3. JPQL Fetch Joins

A `FETCH JOIN` enables the fetching of an association as a side effect of the execution of a query. A `FETCH JOIN` is specified over an entity and its related entities. The syntax for a fetch join is

- `fetch_join ::= [ LEFT [OUTER] | INNER ] JOIN FETCH join_association_path_expression`

The association referenced by the right side of the `FETCH JOIN` clause must be an association that belongs to an entity that is returned as a result of the query. It is not permitted to specify an identification variable for the entities referenced by the right side of the `FETCH JOIN` clause, and hence references to the implicitly fetched entities cannot appear elsewhere in the query.

The following query returns a set of magazines. As a side effect, the associated articles for those magazines are also retrieved, even though they are not part of the explicit query result. The persistent fields or properties of the articles that are eagerly fetched are fully initialized. The initialization of the relationship properties of the `articles` that are retrieved is determined by the metadata for the `Article` entity class.

```
SELECT mag FROM Magazine mag LEFT JOIN FETCH mag.articles WHERE mag.id = 1
```

A fetch join has the same join semantics as the corresponding inner or outer join, except that the related objects specified on the right-hand side of the join operation are not returned in the query result or otherwise referenced in the query. Hence, for example, if magazine id 1 has five articles, the above query returns five references to the magazine 1 entity.

The `FETCH JOIN` construct must not be used in the `FROM` clause of a subquery.

### 10.2.3.6. JPQL Collection Member Declarations

An identification variable declared by a `collection_member_declaration` ranges over values of a collection obtained by navigation using a path expression. Such a path expression represents a navigation involving the association-fields of an entity abstract schema type. Because a path expression can be based on another path expression, the navigation can use the association-fields of related entities.

An identification variable of a collection member declaration is declared using a special operator, the reserved identifier `IN`. The argument to the `IN` operator is a collection-valued path expression. The path expression evaluates to a collection type specified as a result of navigation to a collection-valued association-field of an entity or embeddable class abstract schema type.



The syntax for declaring a collection member identification variable is as follows:

- `collection_member_declaration ::= IN (collection_valued_path_expression) [AS] identification_variable`

For example, the query

```
SELECT DISTINCT mag FROM Magazine mag
JOIN mag.articles art
JOIN art.author auth
WHERE auth.lastName = 'Grisham'
```

can equivalently be expressed as follows, using the `IN` operator:

```
SELECT DISTINCT mag FROM Magazine mag,
IN(mag.articles) art
WHERE art.author.lastName = 'Grisham'
```

In this example, `articles` is the name of an association-field whose value is a collection of instances of the abstract schema type `Article`. The identification variable `art` designates a member of this collection, a single `Article` abstract schema type instance. In this example, `mag` is an identification variable of the abstract schema type `Magazine`.

### 10.2.3.7. JPQL FROM Clause and SQL

The Java Persistence query language treats the `FROM` clause similarly to SQL in that the declared identification variables affect the results of the query even if they are not used in the `WHERE` clause. Application developers should use caution in defining identification variables because the domain of the query can depend on whether there are any values of the declared type.

For example, the `FROM` clause below defines a query over all orders that have line items and existing products. If there are no `Product` instances in the database, the domain of the query is empty and no order is selected.

```
SELECT o
FROM Order AS o JOIN o.lineItems l JOIN l.product p
```

### 10.2.3.8. JPQL Polymorphism

Java Persistence queries are automatically polymorphic. The `FROM` clause of a query designates not only instances of the specific entity classes to which explicitly refers but of subclasses as well. The instances returned by a query include instances of the subclasses that satisfy the query criteria.

Non-polymorphic queries or queries whose polymorphism is restricted can be specified using entity type expressions in the `WHERE` clause to restrict the domain of the query. See [Section 10.2.6.4, “Entity Type Expressions” \[128\]](#).

## 10.2.4. JPQL WHERE Clause

The `WHERE` clause of a query consists of a conditional expression used to select objects or values that satisfy the expression. The `WHERE` clause restricts the result of a select statement or the scope of an update or delete operation.

A `WHERE` clause is defined as follows:

- `where_clause ::= WHERE conditional_expression`

The `GROUP BY` construct enables the aggregation of values according to the properties of an entity class. The `HAVING` construct enables conditions to be specified that further restrict the query result as restrictions upon the groups.

The syntax of the `HAVING` clause is as follows:

- `having_clause ::= HAVING conditional_expression`

The `GROUP BY` and `HAVING` constructs are further discussed in [Section 10.2.7, “JPQL GROUP BY, HAVING” \[129\]](#).

## 10.2.5. JPQL Conditional Expressions

The following sections describe the language constructs that can be used in a conditional expression of the `WHERE` clause or `HAVING` clause.

State-fields that are mapped in serialized form or as LOBs may not be portably used in conditional expressions.

### Note

The implementation is not expected to perform such query operations involving such fields in memory rather than in the database.

### 10.2.5.1. JPQL Literals

A string literal is enclosed in single quotes—for example: `'literal'`. A string literal that includes a single quote is represented by two single quotes—for example: `'literal's'`. String literals in queries, like Java String literals, use unicode character encoding. The use of Java escape notation is not supported in query string literals.

Exact numeric literals support the use of Java integer literal syntax as well as SQL exact numeric literal syntax.

Approximate literals support the use of Java floating point literal syntax as well as SQL approximate numeric literal syntax.

Enum literals support the use of Java enum literal syntax. The enum class name must be specified.

Appropriate suffixes can be used to indicate the specific type of a numeric literal in accordance with the Java Language Specification. The boolean literals are `TRUE` and `FALSE`. Although predefined reserved literals appear in upper case, they are case insensitive.

The JDBC escape syntax may be used for the specification of date, time, and timestamp literals. For example:

```
SELECT o
FROM Customer c JOIN c.orders o
WHERE c.name = 'Smith'
AND o.submissionDate < {d '2008-12-31'}
```

Date, time, and timestamp literals are passed as is to the JDBC driver in use.

Entity type literals are specified by entity names—for example: `Customer`.

Although reserved literals appear in upper case, they are case insensitive.

### 10.2.5.2. JPQL Identification Variables

All identification variables used in the `WHERE` or `HAVING` clause of a `SELECT` or `DELETE` statement must be declared in the `FROM` clause, as described in [Section 10.2.3.2, “JPQL Identification Variables” \[111\]](#). The identification variables used in the `WHERE` clause of an `UPDATE` statement must be declared in the `UPDATE` clause.

Identification variables are existentially quantified in the `WHERE` and `HAVING` clause. This means that an identification variable represents a member of a collection or an instance of an entity's abstract schema type. An identification variable never designates a collection in its entirety.

### 10.2.5.3. JPQL Path Expressions

It is illegal to use a `collection_valued_path_expression` within a `WHERE` or `HAVING` clause as part of a conditional expression except in an `empty_collection_comparison_expression`, in a `collection_member_expression`, or as an argument to the `SIZE` operator.

### 10.2.5.4. JPQL Input Parameters

Either positional or named parameters may be used. Positional and named parameters may not be mixed in a single query.

Input parameters can only be used in the `WHERE` clause or `HAVING` clause of a query.

Note that if an input parameter value is null, comparison operations or arithmetic operations involving the input parameter will return an unknown value. See [Section 10.2.11, “JPQL Null Values” \[137\]](#).

All input parameters must be single-valued, except in `IN` expressions (see [Section 10.2.5.9, “JPQL In Expressions” \[122\]](#)), which support the use of collection-valued input parameters.

#### 10.2.5.4.1. JPQL Positional Parameters

The following rules apply to positional parameters.

- Input parameters are designated by the question mark (?) prefix followed by an integer. For example: ?1.
- Input parameters are numbered starting from 1.
- The same parameter can be used more than once in the query string.
- The ordering of the use of parameters within the query string need not conform to the order of the positional parameters.

#### 10.2.5.4.2. JPQL Named Parameters

A named parameter is an identifier that is prefixed by the ":" symbol. It follows the rules for identifiers defined in [Section 10.2.3.1, “JPQL FROM Identifiers” \[108\]](#). Named parameters are case sensitive.

Example:

```
SELECT pub FROM Publisher pub WHERE pub.revenue > :rev
```

The same named parameter can be used more than once in the query string.

### 10.2.5.5. JPQL Conditional Expression Composition

Conditional expressions are composed of other conditional expressions, comparison operations, logical operations, path expressions that evaluate to boolean values, boolean literals, and boolean input parameters.

The scalar expressions described in [Section 10.2.6, “JPQL Scalar Expressions” \[126\]](#) can be used in conditional expressions.

Standard bracketing () for ordering expression evaluation is supported.

Aggregate functions can only be used in conditional expressions in a `HAVING` clause. See [Section 10.2.7, “JPQL GROUP BY, HAVING” \[129\]](#).

Conditional expressions are defined as follows:

- `conditional_expression ::= conditional_term | conditional_expression OR conditional_term`
- `conditional_term ::= conditional_factor | conditional_term AND conditional_factor`
- `conditional_factor ::= [ NOT ] conditional_primary`
- `conditional_primary ::= simple_cond_expression | (conditional_expression)`
- `simple_cond_expression ::= comparison_expression | between_expression | like_expression | in_expression | null_comparison_expression | empty_collection_comparison_expression | collection_member_expression | exists_expression`

### 10.2.5.6. JPQL Operators and Operator Precedence

The operators are listed below in order of decreasing precedence.

- Navigation operator (`.`)
- Arithmetic operators: `+`, `-` unary `*`, `/` multiplication and division `+`, `-` addition and subtraction
- Comparison operators: `=`, `>`, `>=`, `<`, `<=`, `<>` (not equal), `[ NOT ] BETWEEN`, `[ NOT ] LIKE`, `[ NOT ] IN`, `IS [ NOT ] NULL`, `IS [ NOT ] EMPTY`, `[ NOT ] MEMBER [ OF ]`
- Logical operators: `NOT`, `AND`, `OR`

The following sections describe other operators used in specific expressions.

### 10.2.5.7. JPQL Comparison Expressions

The syntax for the use of comparison expressions in a conditional expression is as follows:

- `comparison_expression ::= string_expression comparison_operator {string_expression | all_or_any_expression} | boolean_expression { =|<> } {boolean_expression | all_or_any_expression} | enum_expression { =|<> } {enum_expression | all_or_any_expression} | datetime_expression comparison_operator {datetime_expression | all_or_any_expression} | entity_expression { =|<> } {entity_expression | all_or_any_expression} | arithmetic_expression comparison_operator {arithmetic_expression | all_or_any_expression} | entity_type_expression { =|<> } entity_type_expression`
- `comparison_operator ::= = | > | >= | < | <= | <>`

Examples:

```
item.cost * 1.08 <= 100.00
```

```
CONCAT(person.lastName, ' ', person.firstName) = 'Jones, Sam'
```

```
TYPE(e) = ExemptEmployee
```

## Note

Comparisons over instances of embeddable class types are not supported.

### 10.2.5.8. JPQL Between Expressions

The syntax for the use of the comparison operator [ NOT ] BETWEEN in a conditional expression is as follows:

```
arithmetic_expression [NOT] BETWEEN arithmetic_expression AND arithmetic_expression | string_expression [NOT]
BETWEEN string_expression AND string_expression | datetime_expression [NOT] BETWEEN datetime_expression AND
datetime_expression
```

The BETWEEN expression

```
x BETWEEN y AND z
```

is semantically equivalent to:

```
y <= x AND x <= z
```

The rules for unknown and NULL values in comparison operations apply. See [Section 10.2.11, “JPQL Null Values” \[137\]](#).

Examples are:

```
p.age BETWEEN 15 and 19
```

is equivalent to:

```
p.age >= 15 AND p.age <= 19
```

The following expression:

```
p.age NOT BETWEEN 15 and 19
```

excludes the range, and is equivalent to:

```
p.age < 15 OR p.age > 19
```

In the following example, `transactionHistory` is a list of credit card transactions defined using an order column.

```
SELECT t
FROM CreditCard c JOIN c.transactionHistory t
WHERE c.holder.name = 'John Doe' AND INDEX(t) BETWEEN 0 AND 9
```

### 10.2.5.9. JPQL In Expressions

The syntax for the use of the comparison operator [ NOT ] IN in a conditional expression is as follows:

- `in_expression ::= state_field_path_expression [NOT] IN (( in_item { , in_item }* ) | (subquery) | collection_valued_input_parameter )`
- `in_item ::= literal | single_valued_input_parameter`

The `state_field_path_expression` must have a string, numeric, date, time, timestamp, or enum value.

The literal and/or `input_parameter` values must be like the same abstract schema type of the `state_field_path_expression` in type. (See [Section 10.2.12, “JPQL Equality and Comparison Semantics” \[137\]](#)).

The results of the subquery must be like the same abstract schema type of the `state_field_path_expression` in type. Subqueries are discussed in [Section 10.2.5.16, “JPQL Subqueries” \[125\]](#).

Examples:

```
o.country IN ('UK', 'US', 'France')
```

is true for UK and false for Peru, and is equivalent to the expression:

```
(o.country = 'UK') OR (o.country = 'US') OR (o.country = 'France')
```

In the following expression:

```
o.country NOT IN ('UK', 'US', 'France')
```

is false for UK and true for Peru, and is equivalent to the expression:

```
NOT ((o.country = 'UK') OR (o.country = 'US') OR (o.country = 'France'))
```

There must be at least one element in the comma separated list that defines the set of values for the IN expression.

If the value of a `state_field_path_expression` or `in_item` in an IN or NOT IN expression is NULL or unknown, the value of the expression is unknown.

Note that use of a collection-valued input parameter will mean that a static query cannot be precompiled.

### 10.2.5.10. JPQL Like Expressions

The syntax for the use of the comparison operator [ NOT ] LIKE in a conditional expression is as follows:

```
like_expression ::= string_expression [NOT] LIKE pattern_value [ESCAPE escape_character]
```

The `string_expression` must have a string value. The `pattern_value` is a string literal or a string-valued input parameter in which an underscore (`_`) stands for any single character, a percent (`%`) character stands for any sequence of characters (including the empty sequence), and all other characters stand for themselves. The optional `escape_character` is a

single-character string literal or a character-valued input parameter (i.e., char or Character) and is used to escape the special meaning of the underscore and percent characters in `pattern_value`.

Examples:

```
address.phone LIKE '12%3'
```

is true for '123' '12993' and false for '1234'

```
asentence.word LIKE 'l_se'
```

is true for 'lose' and false for 'loose'

```
aword.underscored LIKE '\_%' ESCAPE '\'
```

is true for '\_foo' and false for 'bar'

```
address.phone NOT LIKE '12%3'
```

is false for '123' and '12993' and true for '1234'.

If the value of the `string_expression` or `pattern_value` is `NULL` or unknown, the value of the `LIKE` expression is unknown. If the `escape_character` is specified and is `NULL`, the value of the `LIKE` expression is unknown.

### 10.2.5.11. JPQL Null Comparison Expressions

The syntax for the use of the comparison operator `IS NULL` in a conditional expression is as follows:

```
null_comparison_expression ::= {single_valued_path_expression | input_parameter } IS [NOT] NULL
```

A null comparison expression tests whether or not the single-valued path expression or input parameter is a `NULL` value.

Null comparisons over instances of embeddable class types are not supported.

### 10.2.5.12. JPQL Empty Collection Comparison Expressions

The syntax for the use of the comparison operator `IS EMPTY` in an `empty_collection_comparison_expression` is as follows:

```
empty_collection_comparison_expression ::= collection_valued_path_expression IS [NOT] EMPTY
```

This expression tests whether or not the collection designated by the collection-valued path expression is empty (i.e. has no elements).

For example, the following query will return all magazines that don't have any articles at all:

```
SELECT mag FROM Magazine mag WHERE mag.articles IS EMPTY
```

If the value of the collection-valued path expression in an empty collection comparison expression is unknown, the value of the empty comparison expression is unknown.

### 10.2.5.13. JPQL Collection Member Expressions

The syntax for the use of the comparison operator `MEMBER OF` in an `collection_member_expression` is as follows:

- `collection_member_expression ::= entity_or_value_expression [NOT] MEMBER [OF] collection_valued_path_expression`
- `entity_or_value_expression ::= single_valued_object_path_expression | state_field_path_expression | simple_entity_or_value_expression`
- `simple_entity_or_value_expression ::= identification_variable | input_parameter | literal`

This expression tests whether the designated value is a member of the collection specified by the collection-valued path expression.

Expressions that evaluate to embeddable types are not supported in collection member expressions.

If the collection valued path expression designates an empty collection, the value of the `MEMBER OF` expression is `FALSE` and the value of the `NOT MEMBER OF` expression is `TRUE`. Otherwise, if the value of the `collection_valued_path_expression` or `entity_or_value_expression` in the collection member expression is `NULL` or unknown, the value of the collection member expression is unknown.

The use of the reserved word `OF` is optional in this expression.

Example:

```
SELECT p
FROM Person p
WHERE 'Joe' MEMBER OF p.nicknames
```

### 10.2.5.14. JPQL Exists Expressions

An `EXISTS` expression is a predicate that is true only if the result of the subquery consists of one or more values and that is false otherwise. The syntax of an exists expression is

- `exists_expression ::= [NOT] EXISTS (subquery)`

Example:

```
SELECT DISTINCT auth FROM Author auth
WHERE EXISTS
  (SELECT spouseAuthor FROM Author spouseAuthor WHERE spouseAuthor = auth.spouse)
```

The result of this query consists of all authors whose spouse is also an author.

### 10.2.5.15. JPQL All or Any Expressions

An `ALL` conditional expression is a predicate over a subquery that is true if the comparison operation is true for all values in the result of the subquery or the result of the subquery is empty. An `ALL` conditional expression is false if the result of the comparison is false for at least one value of the result of the subquery, and is unknown if neither true nor false.



An ANY conditional expression is a predicate over a subquery that is true if the comparison operation is true for some value in the result of the subquery. An ANY conditional expression is false if the result of the subquery is empty or if the comparison operation is false for every value in the result of the subquery, and is unknown if neither true nor false. The keyword SOME is synonymous with ANY.

The comparison operators used with ALL or ANY conditional expressions are =, <, <=, >, >=, <>. The result of the subquery must be like that of the other argument to the comparison operator in type. See **Section 10.2.12, “JPQL Equality and Comparison Semantics” [137]**. The syntax of an ALL or ANY expression is specified as follows:

- all\_or\_any\_expression ::= { ALL | ANY | SOME } (subquery)

The following example select the authors who make the highest salary for their magazine:

```
SELECT auth FROM Author auth
WHERE auth.salary >= ALL(SELECT a.salary FROM Author a WHERE a.magazine = auth.magazine)
```

### 10.2.5.16. JPQL Subqueries

Subqueries may be used in the WHERE or HAVING clause. The syntax for subqueries is as follows:

- subquery ::= simple\_select\_clause subquery\_from\_clause [where\_clause] [groupby\_clause] [having\_clause]
- simple\_select\_clause ::= SELECT [DISTINCT] simple\_select\_expression
- subquery\_from\_clause ::= FROM subselect\_identification\_variable\_declaration { , subselect\_identification\_variable\_declaration | collection\_member\_declaration }\*
- subselect\_identification\_variable\_declaration ::= identification\_variable\_declaration | derived\_path\_expression [AS] identification\_variable {join}\* | derived\_collection\_member\_declaration
- simple\_select\_expression ::= single\_valued\_path\_expression | scalar\_expression | aggregate\_expression | identification\_variable
- derived\_path\_expression ::= superquery\_identification\_variable.{single\_valued\_object\_field.\*collection\_valued\_field | superquery\_identification\_variable.{single\_valued\_object\_field.\*single\_valued\_object\_field
- derived\_collection\_member\_declaration ::= IN superquery\_identification\_variable.{single\_valued\_object\_field.\*collection\_valued\_field

Subqueries are restricted to the WHERE and HAVING clauses in this release. Support for subqueries in the FROM clause will be considered in a later release of the specification.

Examples:

```
SELECT DISTINCT auth FROM Author auth
WHERE EXISTS (SELECT spouseAuth FROM Author spouseAuth WHERE spouseAuth = auth.spouse)
```

```
SELECT mag FROM Magazine mag
WHERE (SELECT COUNT(art) FROM mag.articles art) > 10
```

Note that some contexts in which a subquery can be used require that the subquery be a scalar subquery (i.e., produce a single result). This is illustrated in the following example involving a numeric comparison operation.

```
SELECT goodPublisher FROM Publisher goodPublisher
WHERE goodPublisher.revenue < (SELECT AVG(p.revenue) FROM Publisher p)
```

```
SELECT goodCustomer
FROM Customer goodCustomer
WHERE goodCustomer.balanceOwed < (
SELECT AVG(c.balanceOwed)/2.0 FROM Customer c)
```

## 10.2.6. JPQL Scalar Expressions

Numeric, string, datetime, case, and entity type expressions result in scalar values.

Scalar expressions may be used in the `SELECT` clause of a query as well as in the `WHERE` and `HAVING` clauses.

scalar\_expression ::= arithmetic\_expression | string\_primary | enum\_primary | datetime\_primary | boolean\_primary | case\_expression | entity\_type\_expression

### 10.2.6.1. Arithmetic Expressions

The arithmetic operators are:

- +, - unary
- \*, / multiplication and division
- +, - addition and subtraction

Arithmetic operations use numeric promotion.

Arithmetic functions are described in [Section 10.2.6.2.2, “JPQL Arithmetic Functions” \[127\]](#).

### 10.2.6.2. String, Arithmetic, and Datetime Functional Expressions

JPQL includes the built-in functions described in subsections [Section 10.2.6.2.1, “JPQL String Functions” \[126\]](#), [Section 10.2.6.2.2, “JPQL Arithmetic Functions” \[127\]](#), [Section 10.2.6.2.3, “JPQL Datetime Functions” \[127\]](#), which may be used in the `SELECT`, `WHERE` or `HAVING` clause of a query.

If the value of any argument to a functional expression is null or unknown, the value of the functional expression is unknown.

#### 10.2.6.2.1. JPQL String Functions

- functions\_returning\_strings ::= `CONCAT(string_primary, string_primary) | SUBSTRING(string_primary, simple_arithmetic_expression[, simple_arithmetic_expression]) | TRIM([[trim_specification] [trim_character] FROM] string_primary) | LOWER(string_primary) | UPPER(string_primary)`
- trim\_specification ::= `LEADING | TRAILING | BOTH`
- functions\_returning\_numerics ::= `LENGTH(string_primary) | LOCATE(string_primary, string_primary[, simple_arithmetic_expression])`

The `CONCAT` function returns a string that is a concatenation of its arguments.

The second and third arguments of the `SUBSTRING` function denote the starting position and length of the substring to be returned. These arguments are integers. The third argument is optional. If it is not specified, the substring from the start position to the end of the string is returned. The first position of a string is denoted by 1. The `SUBSTRING` function returns a string.

The `TRIM` function trims the specified character from a string. If the character to be trimmed is not specified, it is assumed to be space (or blank). The optional `trim_character` is a single-character string literal or a character-valued input parameter (i.e., `char` or `Character`). If a trim specification is not provided, `BOTH` is assumed. The `TRIM` function returns the trimmed string.

The `LOWER` and `UPPER` functions convert a string to lower and upper case, respectively. They return a string.

The `LOCATE` function returns the position of a given string within a string, starting the search at a specified position. It returns the first position at which the string was found as an integer. The first argument is the string to be located; the second argument is the string to be searched; the optional third argument is an integer that represents the string position at which the search is started (by default, the beginning of the string to be searched). The first position in a string is denoted by 1. If the string is not found, 0 is returned.

The `LENGTH` function returns the length of the string in characters as an integer.

---

### 10.2.6.2.2. JPQL Arithmetic Functions

---

- `functions_returning_numerics ::= ABS(simple_arithmetic_expression) | SQRT(simple_arithmetic_expression) | MOD(simple_arithmetic_expression, simple_arithmetic_expression) | SIZE(collection_valued_path_expression) | INDEX(identification_variable)`

The `ABS` function takes a numeric argument and returns a number (integer, float, or double) of the same type as the argument to the function.

The `SQRT` function takes a numeric argument and returns a double.

Note that not all databases support the use of a trim character other than the space character; use of this argument may result in queries that are not portable. Note that not all databases support the use of the third argument to `LOCATE`; use of this argument may result in queries that are not portable.

The `MOD` function takes two integer arguments and returns an integer.

The `SIZE` function returns an integer value, the number of elements of the collection. If the collection is empty, the `SIZE` function evaluates to zero. Numeric arguments to these functions may correspond to the numeric Java object types as well as the primitive numeric types.

The `INDEX` function returns an integer value corresponding to the position of its argument in an ordered list. The `INDEX` function can only be applied to identification variables denoting types for which an order column has been specified.

---

### 10.2.6.2.3. JPQL Datetime Functions

---

`functions_returning_datetime:= CURRENT_DATE | CURRENT_TIME | CURRENT_TIMESTAMP`

The datetime functions return the value of current date, time, and timestamp on the database server.

---

### 10.2.6.3. Case Expressions

---

The following forms of case expressions are supported: general case expressions, simple case expressions, coalesce expressions, and nullif expressions. `CASEELSEEND`

- `case_expression ::= general_case_expression | simple_case_expression | coalesce_expression | nullif_expression`
- `general_case_expression ::= CASE when_clause {when_clause}* ELSE scalar_expression END`

- `when_clause ::= WHEN conditional_expression THEN scalar_expression`
- `case_operand ::= state_field_path_expression | type_discriminator`
- `simple_when_clause ::= WHEN scalar_expression THEN scalar_expression`
- `coalesce_expression ::= COALESCE(scalar_expression {, scalar_expression}+)`
- `nullif_expression ::= NULLIF(scalar_expression, scalar_expression)`

Examples:

```
UPDATE Employee e
SET e.salary =
    CASE WHEN e.rating = 1 THEN e.salary * 1.1
         WHEN e.rating = 2 THEN e.salary * 1.05
         ELSE e.salary * 1.01
    END
```

```
UPDATE Employee e
SET e.salary =
    CASE e.rating WHEN 1 THEN e.salary * 1.1
              WHEN 2 THEN e.salary * 1.05
              ELSE e.salary * 1.01
    END
```

```
SELECT e.name,
       CASE TYPE(e) WHEN Exempt THEN 'Exempt'
                  WHEN Contractor THEN 'Contractor'
                  WHEN Intern THEN 'Intern'
                  ELSE 'NonExempt'
       END
FROM Employee e
WHERE e.dept.name = 'Engineering'
```

```
SELECT e.name,
       f.name,
       CONCAT(CASE WHEN f.annualMiles > 50000 THEN 'Platinum '
                  WHEN f.annualMiles > 25000 THEN 'Gold '
                  ELSE ''
                  END,
              'Frequent Flyer')
FROM Employee e JOIN e.frequentFlierPlan f
```

#### 10.2.6.4. Entity Type Expressions

An entity type expression can be used to restrict query polymorphism. The `TYPE` operator returns the exact type of the argument.

The syntax of an entity type expression is as follows:

- `entity_type_expression ::= type_discriminator | entity_type_literal | input_parameter`
- `type_discriminator ::= TYPE(identification_variable | single_valued_object_path_expression | input_parameter )`

An `entity_type_literal` is designated by the entity name.

The Java class of the entity is used as an input parameter to specify the entity type.

Examples:

```
SELECT e
FROM Employee e
WHERE TYPE(e) IN (Exempt, Contractor)
```

```
SELECT e
FROM Employee e
WHERE TYPE(e) IN (:empType1, :empType2)
```

```
SELECT e
FROM Employee e
WHERE TYPE(e) IN :empTypes
```

```
SELECT TYPE(e)
FROM Employee e
WHERE TYPE(e) <> Exempt
```

## 10.2.7. JPQL GROUP BY, HAVING

The `GROUP BY` construct enables the aggregation of values according to a set of properties. The `HAVING` construct enables conditions to be specified that further restrict the query result. Such conditions are restrictions upon the groups.

The syntax of the `GROUP BY` and `HAVING` clauses is as follows:

- `groupby_clause ::= GROUP BY groupby_item {, groupby_item}*`
- `groupby_item ::= single_valued_path_expression | identification_variable`
- `having_clause ::= HAVING conditional_expression`

If a query contains both a `WHERE` clause and a `GROUP BY` clause, the effect is that of first applying the where clause, and then forming the groups and filtering them according to the `HAVING` clause. The `HAVING` clause causes those groups to be retained that satisfy the condition of the `HAVING` clause.

The requirements for the `SELECT` clause when `GROUP BY` is used follow those of `SQL`: namely, any item that appears in the `SELECT` clause (other than as an argument to an aggregate function) must also appear in the `GROUP BY` clause. In forming the groups, null values are treated as the same for grouping purposes.

Grouping by an entity is permitted. In this case, the entity must contain no serialized state fields or LOB-valued state fields that are eagerly fetched.

Grouping by embeddables is not supported.

The `HAVING` clause must specify search conditions over the grouping items or aggregate functions that apply to grouping items.

If there is no `GROUP BY` clause and the `HAVING` clause is used, the result is treated as a single group, and the select list can only consist of aggregate functions. The use of `HAVING` in the absence of `GROUP BY` is not required to be supported by a JPA implementation. Portable applications should not rely on `HAVING` without the use of `GROUP BY`.

### Note

OpenJPA supports the use of `HAVING` in the absence of `GROUP BY` if the underlying database supports it.

Examples:

```
SELECT c.status, AVG(c.filledOrderCount), COUNT(c)
FROM Customer c
GROUP BY c.status
HAVING c.status IN (1, 2)
```

```
SELECT c.country, COUNT(c)
FROM Customer c
GROUP BY c.country
HAVING COUNT(c) > 30
```

## 10.2.8. JPQL SELECT Clause

The `SELECT` clause denotes the query result. More than one value may be returned from the `SELECT` clause of a query.

The `SELECT` clause can contain one or more of the following elements: a single range variable or identification variable that ranges over an entity abstract schema type, a single-valued path expression, a scalar expression, an aggregate expression, a constructor expression.

The `SELECT` clause has the following syntax:

- `select_clause ::= SELECT [DISTINCT] select_item {, select_item}*`
- `select_item ::= select_expression [ [AS] result_variable]`
- `select_expression ::= single_valued_path_expression | scalar_expression | aggregate_expression | identification_variable | OBJECT(identification_variable) | constructor_expression`
- `constructor_expression ::= NEW constructor_name ( constructor_item {, constructor_item}*)`
- `constructor_item ::= single_valued_path_expression | scalar_expression | aggregate_expression | identification_variable`
- `aggregate_expression ::= { AVG | MAX | MIN | SUM } ([DISTINCT] state_field_path_expression) | COUNT ([DISTINCT] identification_variable | state_field_path_expression | single_valued_object_path_expression)`

For example:

```
SELECT pub.id, pub.revenue
FROM Publisher pub JOIN pub.magazines mag WHERE mag.price > 5.00
```

In the following example, `videoInventory` is a `Map` from the entity `Movie` to the number of copies in stock:

```
SELECT v.location.street, KEY(i).title, VALUE(i)
FROM VideoStore v JOIN v.videoInventory i
WHERE v.location.zipcode = '94301' AND VALUE(i) > 0
```

Note that the `SELECT` clause must be specified to return only single-valued expressions. The query below is therefore not valid:

```
SELECT mag.authors FROM Magazine AS mag
```

The `DISTINCT` keyword is used to specify that duplicate values must be eliminated from the query result.

If `DISTINCT` is not specified, duplicate values are not eliminated.

The result of `DISTINCT` over embeddable objects or map entry results is undefined.

Standalone identification variables in the `SELECT` clause may optionally be qualified by the `OBJECT` operator. The `SELECT` clause must not use the `OBJECT` operator to qualify path expressions.

A `result_variable` may be used to name a `select_item` in the query result. For example,

```
SELECT c, COUNT(l) AS itemCount
FROM Customer c JOIN c.Orders o JOIN o.lineItems l
WHERE c.address.state = 'CA'
ORDER BY itemCount
```

### 10.2.8.1. JPQL Result Type of the SELECT Clause

The type of the query result specified by the `SELECT` clause of a query is an entity abstract schema type, a state-field type, the result of a scalar expression, the result of an aggregate function, the result of a construction operation, or some sequence of these.

The result type of the `SELECT` clause is defined by the result types of the `select_expressions` contained in it. When multiple `select_expressions` are used in the `SELECT` clause, the result of the query is of type `Object[]`, and the elements in this result correspond in order to the order of their specification in the `SELECT` clause and in type to the result types of each of the `select_expressions`.

The type of the result of a `select_expression` is as follows:

- The result type of an `identification_variable` is the type of the entity object or embeddable object to which the identification variable corresponds. The type of an `identification_variable` that refers to an entity abstract schema type is the type of the entity to which that identification variable corresponds or a subtype as determined by the object/relational mapping.
- The result type of a `single_valued_path_expression` that is a `state_field_path_expression` results in an object of the same type as the corresponding state field of the entity or embeddable class. If the state field of the entity is a primitive type, the result type is the corresponding object type.
- The result type of a `single_valued_path_expression` that is a `single_valued_object_path_expression` is the type of the entity object or embeddable object to which the path expression corresponds. A `single_valued_object_path_expression` that results in an entity object will result in an entity of the type of the relationship field or the subtype of the relationship field of the entity object as determined by the object/relational mapping.

- The result type of a `single_valued_path_expression` that is an `identification_variable` to which the `KEY` or `VALUE` function has been applied is determined by the type of the map key or value respectively, as defined by the above rules
- The result type of a `single_valued_path_expression` that is an `identification_variable` to which the `ENTRY` function has been applied is `java.util.Map.Entry`, where the key and value types of the map entry are determined by the above rules as applied to the map key and map value respectively.
- The result type of a `scalar_expression` is the type of the scalar value to which the expression evaluates. The result type of a numeric `scalar_expression` is defined in [Section 10.2.6, “JPQL Scalar Expressions” \[126\]](#)
- The result type of an `entity_type_expression` scalar expression is the Java class to which the resulting abstract schema type corresponds.
- The result type of `aggregate_expression` is defined in [Section 10.2.8.5, “JPQL Aggregate Functions” \[133\]](#).
- The result type of a `constructor_expression` is the type of the class for which the constructor is defined. The types of the arguments to the constructor are defined by the above rules.

### 10.2.8.2. JPQL Constructor Expressions

A constructor may be used in the `SELECT` list to return one or more Java instances. The specified class is not required to be an entity or to be mapped to the database. The constructor name must be fully qualified.

If an entity class name is specified in the `SELECT NEW` clause, the resulting entity instances are in the new state.

If a `single_valued_path_expression` or `identification_variable` that is an argument to the constructor references an entity, the resulting entity instance referenced by that `single_valued_path_expression` or `identification_variable` will be in the managed state.

If `PublisherInfo` is an entity class, the following 2 queries return instances of `PublisherInfo` that will be in the new state. In the second example, `mag` is an `identification_variable` passed as an argument to the constructor `PublisherInfo(Magazine mag)`; the entity instances of `Magazine` created during query evaluation will be in the managed state. Example:

```
SELECT NEW com.company.PublisherInfo(pub.id, pub.revenue, mag.price)
FROM Publisher pub JOIN pub.magazines mag WHERE mag.price > 5.00
```

```
SELECT NEW com.company.PublisherInfo(mag)
FROM Publisher pub JOIN pub.magazines mag WHERE mag.price > 5.00
```

### 10.2.8.3. JPQL Null Values in the Query Result

If the result of a query corresponds to a association-field or state-field whose value is null, that null value is returned in the result of the query method. The `IS NOT NULL` construct can be used to eliminate such null values from the result set of the query.

Note, however, that state-field types defined in terms of Java numeric primitive types cannot produce `NULL` values in the query result. A query that returns such a state-field type as a result type must not return a null value.

### 10.2.8.4. JPQL Embeddables in the Query Result

If the result of a query corresponds to an identification variable or state field whose value is an embeddable, the embeddable instance returned by the query will not be in the managed state (i.e., it will not be part of the state of any managed entity).



In the following example, the `Address` instances returned by the query will reference `Phone` instances. While the `Phone` instances will be managed, the `Address` instances referenced by the `addr` result variable will not be. Modifications to these embeddable instances are not allowed.

```

@Entity
public class Employee {
    @Id int id;
    Address address;
    ...
}

@Embeddable
public class Address {
    String street;
    ...
    @OneToOne Phone phone; // fetch=EAGER
}

@Entity
public class Phone {
    @Id int id;
    ...
    @OneToOne(mappedBy="address.phone") Employee emp; // fetch=EAGER
}

SELECT e.address AS addr
FROM Employee e

```

### 10.2.8.5. JPQL Aggregate Functions

The result of a query may be the result of an aggregate function applied to a path expression.

The following aggregate functions can be used in the `SELECT` clause of a query: `AVG`, `COUNT`, `MAX`, `MIN`, `SUM`.

For all aggregate functions except `COUNT`, the path expression that is the argument to the aggregate function must terminate in a state-field. The path expression argument to `COUNT` may terminate in either a state-field or a association-field, or the argument to `COUNT` may be an identification variable.

Arguments to the functions `SUM` and `AVG` must be numeric. Arguments to the functions `MAX` and `MIN` must correspond to orderable state-field types (i.e., numeric types, string types, character types, or date types).

The Java type that is contained in the result of a query using an aggregate function is as follows:

- `COUNT` returns `Long`.
- `MAX`, `MIN` return the type of the state-field to which they are applied.
- `AVG` returns `Double`.
- `SUM` returns `Long` when applied to state-fields of integral types (other than `BigInteger`); `Double` when applied to state-fields of floating point types; `BigInteger` when applied to state-fields of type `BigInteger`; and `BigDecimal` when applied to state-fields of type `BigDecimal`.

If `SUM`, `AVG`, `MAX`, or `MIN` is used, and there are no values to which the aggregate function can be applied, the result of the aggregate function is `NULL`.

If `COUNT` is used, and there are no values to which `COUNT` can be applied, the result of the aggregate function is 0.

The argument to an aggregate function may be preceded by the keyword `DISTINCT` to specify that duplicate values are to be eliminated before the aggregate function is applied. It is legal to specify `DISTINCT` with `MAX` or `MIN`, but it does not affect the result.

Null values are eliminated before the aggregate function is applied, regardless of whether the keyword `DISTINCT` is specified.

The use of `DISTINCT` with `COUNT` is not supported for arguments of embeddable types or map entry types.

### 10.2.8.5.1. JPQL Aggregate Examples

The following query returns the average price of all magazines:

```
SELECT AVG(mag.price) FROM Magazine mag
```

The following query returns the sum of all the prices from all the magazines published by 'Larry':

```
SELECT SUM(mag.price) FROM Publisher pub JOIN pub.magazines mag WHERE pub.firstName = 'Larry'
```

The following query returns the total number of magazines:

```
SELECT COUNT(mag) FROM Magazine mag
```

### 10.2.8.5.2. JPQL Numeric Expressions in the SELECT Clause

The type of a numeric expression in the query result is determined as follows:

An operand that corresponds to a persistent state-field is of the same type as that persistent state-field.

An operand that corresponds to one of arithmetic functions described in [Section 10.2.6.2.2, “JPQL Arithmetic Functions” \[127\]](#) is of the type defined by [Section 10.2.6.2.2, “JPQL Arithmetic Functions” \[127\]](#).

An operand that corresponds to one of an aggregate functions described in [Section 10.2.8.5, “JPQL Aggregate Functions” \[133\]](#) is of the type defined by [Section 10.2.8.5, “JPQL Aggregate Functions” \[133\]](#).

The result of a case expression, coalesce expression, nullif expression, or arithmetic expression (+, -, \*, /) is determined by applying the following rule to its operands.

- If there is an operand of type `Double` or `double`, the result of the operation is of type `Double`;
- otherwise, if there is an operand of type `Float` or `float`, the result of the operation is of type `Float`;
- otherwise, if there is an operand of type `BigDecimal`, the result of the operation is of type `Big-Decimal`;
- otherwise, if there is an operand of type `BigInteger`, the result of the operation is of type `BigInteger`;
- otherwise, if there is an operand of type `Long` or `long`, the result of the operation is of type `Long`;
- otherwise, if there is an operand of integral type, the result of the operation is of type `Integer`.

## 10.2.9. JPQL ORDER BY Clause

The `ORDER BY` clause allows the objects or values that are returned by the query to be ordered. The syntax of the `ORDER BY` clause is

- `orderby_clause ::= ORDER BY orderby_item {, orderby_item}*`

- `orderby_item ::= { state_field_path_expression | result_variable } [ASC | DESC]`

An `orderby_item` must be one of the following:

- A `state_field_path_expression` that evaluates to an orderable state field of an entity or embeddable class abstract schema type designated in the `SELECT` clause by one of the following:
  - a `general_identification_variable`
  - a `single_valued_object_path_expression`
- A `state_field_path_expression` that evaluates to the same state field of the same entity or embeddable abstract schema type as a `state_field_path_expression` in the `SELECT` clause.
- A `result_variable` that refers to an orderable item in the `SELECT` clause for which the same `result_variable` has been specified. This may be the result of an `aggregate_expression`, a `scalar_expression`, or a `state_field_path_expression` in the `SELECT` clause.

For example, the five queries below are legal.

```
SELECT pub FROM Publisher pub ORDER BY pub.revenue, pub.name
```

```
SELECT o
FROM Customer c JOIN c.orders o JOIN c.address a
WHERE a.state = 'CA'
ORDER BY o.quantity DESC, o.totalcost
```

```
SELECT o.quantity, a.zipcode
FROM Customer c JOIN c.orders o JOIN c.address a
WHERE a.state = 'CA'
ORDER BY o.quantity, a.zipcode
```

```
SELECT o.quantity, o.cost*1.08 AS taxedCost, a.zipcode
FROM Customer c JOIN c.orders o JOIN c.address a
WHERE a.state = 'CA' AND a.county = 'Santa Clara'
ORDER BY o.quantity, taxedCost, a.zipcode
```

```
SELECT AVG(o.quantity) as q, a.zipcode
FROM Customer c JOIN c.orders o JOIN c.address a
WHERE a.state = 'CA'
GROUP BY a.zipcode
ORDER BY q DESC
```

The following two queries are not legal because the `orderby_item` is not reflected in the `SELECT` clause of the query.

```
SELECT p.product_name
```

```
FROM Order o JOIN o.lineItems l JOIN l.product p JOIN o.customer c
WHERE c.lastname = 'Smith' AND c.firstname = 'John'
ORDER BY p.price
```

```
SELECT p.product_name
FROM Order o, IN(o.lineItems) l JOIN o.customer c
WHERE c.lastname = 'Smith' AND c.firstname = 'John'
ORDER BY o.quantity
```

If more than one `orderby_item` is specified, the left-to-right sequence of the `orderby_item` elements determines the precedence, whereby the leftmost `orderby_item` has highest precedence.

The keyword `ASC` specifies that ascending ordering be used; the keyword `DESC` specifies that descending ordering be used. Ascending ordering is the default.

SQL rules for the ordering of null values apply: that is, all null values must appear before all non-null values in the ordering or all null values must appear after all non-null values in the ordering, but it is not specified which.

The ordering of the query result is preserved in the result of the query method if the `ORDER BY` clause is used.

## 10.2.10. JPQL Bulk Update and Delete

Bulk update and delete operations apply to entities of a single entity class (together with its subclasses, if any). Only one entity abstract schema type may be specified in the `FROM` or `UPDATE` clause. The syntax of these operations is as follows:

- `update_statement ::= update_clause [where_clause]`
- `update_clause ::= UPDATE entity_name [[AS] identification_variable] SET update_item {, update_item}*`
- `update_item ::= [identification_variable.]{state_field | single_valued_object_field} = new_value`
- `new_value ::= scalar_expression | simple_entity_expression | NULL`
- `delete_statement ::= delete_clause [where_clause]`
- `delete_clause ::= DELETE FROM entity_name [[AS] identification_variable]`

The syntax of the `WHERE` clause is described in [Section 10.2.4, “JPQL WHERE Clause” \[117\]](#).

A delete operation only applies to entities of the specified class and its subclasses. It does not cascade to related entities.

The `new_value` specified for an update operation must be compatible in type with the state-field to which it is assigned.

Bulk update maps directly to a database update operation, bypassing optimistic locking checks. Portable applications must manually update the value of the version column, if desired, and/or manually validate the value of the version column.

The persistence context is not synchronized with the result of the bulk update or delete.

Caution should be used when executing bulk update or delete operations because they may result in inconsistencies between the database and the entities in the active persistence context. In general, bulk update and delete operations should only be performed within a transaction in a new persistence context or at the beginning of a transaction (before entities have been accessed whose state might be affected by such operations).

Examples:

```
DELETE FROM Publisher pub WHERE pub.revenue > 1000000.0
```

```
DELETE FROM Publisher pub WHERE pub.revenue = 0 AND pub.magazines IS EMPTY
```

```
UPDATE Publisher pub SET pub.status = 'outstanding'  
WHERE pub.revenue < 1000000 AND 20 > (SELECT COUNT(mag) FROM pub.magazines mag)
```

## 10.2.11. JPQL Null Values

When the target of a reference does not exist in the database, its value is regarded as `NULL`. SQL 92 `NULL` semantics defines the evaluation of conditional expressions containing `NULL` values. The following is a brief description of these semantics:

- Comparison or arithmetic operations with a `NULL` value always yield an unknown value.
- Two `NULL` values are not considered to be equal, the comparison yields an unknown value.
- Comparison or arithmetic operations with an unknown value always yield an unknown value.
- The `IS NULL` and `IS NOT NULL` operators convert a `NULL` state-field or single-valued association-field value into the respective `TRUE` or `FALSE` value.

Note: The JPQL defines the empty string, `""`, as a string with 0 length, which is not equal to a `NULL` value. However, `NULL` values and empty strings may not always be distinguished when queries are mapped to some databases. Application developers should therefore not rely on the semantics of query comparisons involving the empty string and `NULL` value.

## 10.2.12. JPQL Equality and Comparison Semantics

Only the values of `like` types are permitted to be compared. A type is `like` another type if they correspond to the same Java language type, or if one is a primitive Java language type and the other is the wrapped Java class type equivalent (e.g., `int` and `Integer` are like types in this sense). There is one exception to this rule: it is valid to compare numeric values for which the rules of numeric promotion apply. Conditional expressions attempting to compare non-like type values are disallowed except for this numeric case.

Note that the arithmetic operators and comparison operators are permitted to be applied to state-fields and input parameters of the wrapped Java class equivalents to the primitive numeric Java types.

Two entities of the same abstract schema type are equal if and only if they have the same primary key value.

Equality/inequality comparisons over enums are supported.

Comparisons over instances of embeddable class or map entry types are not supported.

## 10.2.13. JPQL BNF

The following is the BNF for the Java Persistence query language, from section 4.14 of the JSR 317 specification.

```
select_item ::= select_expression [[AS] result_variable]
```

- `QL_statement ::= select_statement | update_statement | delete_statement`

- `select_statement ::= select_clause from_clause [where_clause] [groupby_clause] [having_clause] [orderby_clause]`
- `update_statement ::= update_clause [where_clause]`
- `delete_statement ::= delete_clause [where_clause]`
- `from_clause ::= FROM identification_variable_declaration {, {identification_variable_declaration | collection_member_declaration}}*`
- `identification_variable_declaration ::= range_variable_declaration { join | fetch_join }*`
- `range_variable_declaration ::= entity_name [ AS ] identification_variable`
- `join ::= join_spec join_association_path_expression [ AS ] identification_variable`
- `fetch_join ::= join_spec FETCH join_association_path_expression`
- `join_spec ::= [ LEFT [ OUTER ] | INNER ] JOIN`
- `join_association_path_expression ::= join_collection_valued_path_expression | join_single_valued_path_expression`
- `join_collection_valued_path_expression ::= identification_variable. {single_valued_embeddable_object_field.}*collection_valued_field`
- `join_single_valued_path_expression ::= identification_variable. {single_valued_embeddable_object_field.}*single_valued_object_field`
- `collection_member_declaration ::= IN (join_collection_valued_path_expression) [ AS ] identification_variable`
- `qualified_identification_variable ::= KEY(identification_variable) | VALUE(identification_variable) | ENTRY(identification_variable)`
- `single_valued_path_expression ::= qualified_identification_variable | state_field_path_expression | single_valued_object_path_expression`
- `general_identification_variable ::= identification_variable | KEY(identification_variable) | VALUE(identification_variable)`
- `state_field_path_expression ::= general_identification_variable.{single_valued_object_field.}*state_field`
- `single_valued_object_path_expression ::= general_identification_variable.{single_valued_object_field.}*single_valued_object_field`
- `collection_valued_path_expression ::= general_identification_variable.{single_valued_object_field.}*collection_valued_field`
- `update_clause ::= UPDATE entity_name [[ AS ] identification_variable] SET update_item {, update_item}*`
- `update_item ::= [identification_variable.]{state_field | single_valued_object_field}= new_value`
- `new_value ::= scalar_expression | simple_entity_expression | NULL`
- `delete_clause ::= DELETEFROM entity_name [[ AS ] identification_variable]`
- `select_clause ::= SELECT [ DISTINCT ] select_item {, select_item}*`
- 
- `select_expression ::= single_valued_path_expression | scalar_expression | aggregate_expression | identification_variable | OBJECT (identification_variable)| constructor_expression`

- constructor\_expression ::= NEW constructor\_name( constructor\_item {, constructor\_item}\*)
- constructor\_item ::= single\_valued\_path\_expression | scalar\_expression | aggregate\_expression | identification\_variable
- aggregate\_expression ::= { AVG | MAX | MIN | SUM }([ DISTINCT ] state\_field\_path\_expression) | COUNT ([ DISTINCT ] identification\_variable | state\_field\_path\_expression | single\_valued\_object\_path\_expression)
- where\_clause ::= WHERE conditional\_expression
- groupby\_clause ::= GROUPBY groupby\_item {, groupby\_item}\*
- groupby\_item ::= single\_valued\_path\_expression | identification\_variable
- having\_clause ::= HAVING conditional\_expression
- orderby\_clause ::= ORDERBY orderby\_item {, orderby\_item}\*
- orderby\_item ::= state\_field\_path\_expression | result\_variable [ ASC | DESC ]
- subquery ::= simple\_select\_clause subquery\_from\_clause [where\_clause] [groupby\_clause] [having\_clause]
- subquery\_from\_clause ::= FROM subselect\_identification\_variable\_declaration {, subselect\_identification\_variable\_declaration | collection\_member\_declaration}\*
- subselect\_identification\_variable\_declaration ::= identification\_variable\_declaration | derived\_path\_expression [ AS ] identification\_variable | derived\_collection\_member\_declaration
- derived\_path\_expression ::= superquery\_identification\_variable.{single\_valued\_object\_field.}\*collection\_valued\_field | superquery\_identification\_variable.{single\_valued\_object\_field.}\*single\_valued\_object\_field
- derived\_collection\_member\_declaration ::= IN superquery\_identification\_variable.{single\_valued\_object\_field.}\*collection\_valued\_field
- simple\_select\_clause ::= SELECT [ DISTINCT ] simple\_select\_expression
- simple\_select\_expression ::= single\_valued\_path\_expression | scalar\_expression | aggregate\_expression | identification\_variable
- scalar\_expression ::= simple\_arithmetic\_expression | string\_primary | enum\_primary | datetime\_primary | boolean\_primary | case\_expression | entity\_type\_expression
- conditional\_expression ::= conditional\_term | conditional\_expression OR conditional\_term
- conditional\_term ::= conditional\_factor | conditional\_term AND conditional\_factor
- conditional\_factor ::= [ NOT ] conditional\_primary
- conditional\_primary ::= simple\_cond\_expression |(conditional\_expression)
- simple\_cond\_expression ::= comparison\_expression | between\_expression | like\_expression | in\_expression | null\_comparison\_expression | empty\_collection\_comparison\_expression | collection\_member\_expression | exists\_expression
- between\_expression ::= arithmetic\_expression [ NOT ] BETWEEN arithmetic\_expression AND arithmetic\_expression | string\_expression [ NOT ] BETWEEN string\_expression AND string\_expression | datetime\_expression [ NOT ] BETWEEN datetime\_expression AND datetime\_expression
- in\_expression ::= {state\_field\_path\_expression | type\_discriminator} [ NOT ] IN {( in\_item {, in\_item}\*) | (subquery) | collection\_valued\_input\_parameter }

- `in_item ::= literal | single_valued_input_parameter`
- `like_expression ::= string_expression [ NOT ] LIKE pattern_value [ ESCAPE escape_character]`
- `null_comparison_expression ::= {single_valued_path_expression | input_parameter} IS [ NOT ] NULL`
- `empty_collection_comparison_expression ::= collection_valued_path_expression IS [ NOT ] EMPTY`
- `collection_member_expression ::= entity_expression [ NOT ] MEMBER [ OF ] collection_valued_path_expression`
- `entity_or_value_expression ::= single_valued_object_path_expression | state_field_path_expression | simple_entity_or_value_expression`
- `simple_entity_or_value_expression ::= identification_variable | input_parameter | literal`
- `exists_expression ::= [ NOT ] EXISTS (subquery)`
- `all_or_any_expression ::= { ALL | ANY | SOME }(subquery)`
- `comparison_expression ::= string_expressioncomparison_operator{string_expression|all_or_any_expression}| boolean_expression {=|<>} {boolean_expression | all_or_any_expression} | enum_expression {=|<>} {enum_expression | all_or_any_expression} | datetime_expression comparison_operator {datetime_expression | all_or_any_expression} | entity_expression {=|<>} {entity_expression | all_or_any_expression} | arithmetic_expression comparison_operator {arithmetic_expression | all_or_any_expression} | entity_type_expression {=|<>} entity_type_expression`
- `comparison_operator ::= = |> |>= |< |<= |<>`
- `arithmetic_expression ::= simple_arithmetic_expression |(subquery)`
- `simple_arithmetic_expression ::= arithmetic_term | simple_arithmetic_expression {+ |-} arithmetic_term`
- `arithmetic_term ::= arithmetic_factor | arithmetic_term {* /} arithmetic_factor`
- `arithmetic_factor ::= [{+ |-}] arithmetic_primary`
- `arithmetic_primary ::= state_field_path_expression | numeric_literal | (simple_arithmetic_expression) | input_parameter | functions_returning_numerics | aggregate_expression | case_expression`
- `string_expression ::= string_primary |(subquery)`
- `string_primary ::= state_field_path_expression | string_literal | input_parameter | functions_returning_strings | aggregate_expression | case_expression`
- `datetime_expression ::= datetime_primary |(subquery)`
- `datetime_primary ::= state_field_path_expression | input_parameter | functions_returning_datetime | aggregate_expression | case_expression | date_time_timestamp_literal`
- `boolean_expression ::= boolean_primary |(subquery)`
- `boolean_primary ::= state_field_path_expression | boolean_literal | input_parameter | case_expression`
- `enum_expression ::= enum_primary |(subquery)`
- `enum_primary ::= state_field_path_expression | enum_literal | input_parameter | case_expression`
- `entity_expression ::= single_valued_object_path_expression | simple_entity_expression`
- `simple_entity_expression ::= identification_variable | input_parameter`



- `entity_type_expression ::= type_discriminator | entity_type_literal | input_parameter`
- `type_discriminator ::= TYPE(identification_variable | single_valued_object_path_expression | input_parameter)`
- `functions_returning_numerics ::= LENGTH (string_primary)| LOCATE (string_primary,string_primary [, simple_arithmetic_expression]) | ABS (simple_arithmetic_expression) | SQRT (simple_arithmetic_expression) | MOD (simple_arithmetic_expression, simple_arithmetic_expression) | SIZE (collection_valued_path_expression) | INDEX(identification_variable)`
- `functions_returning_datetime ::= CURRENT_DATE | CURRENT_TIME | CURRENT_TIMESTAMP`
- `functions_returning_strings ::= CONCAT (string_primary, string_primary) | SUBSTRING (string_primary, simple_arithmetic_expression[,simple_arithmetic_expression])| TRIM ([[trim_specification] [trim_character] FROM ] string_primary) | LOWER (string_primary) | UPPER (string_primary)`
- `trim_specification ::= LEADING | TRAILING | BOTH`
- `case_expression ::= general_case_expression | simple_case_expression | coalesce_expression | nullif_expression`
- `general_case_expression ::= CASE when_clause {when_clause}* ELSE scalar_expression END`
- `when_clause ::= WHEN conditional_expression THEN scalar_expression`
- `simple_case_expression ::= CASE case_operand simple_when_clause {simple_when_clause}* ELSE scalar_expression END`
- `case_operand ::= state_field_path_expression | type_discriminator`
- `simple_when_clause ::= WHEN scalar_expression THEN scalar_expression`
- `coalesce_expression ::= COALESCE(scalar_expression {, scalar_expression}+)`
- `nullif_expression ::= NULLIF(scalar_expression, scalar_expression)`

---

# Chapter 11. JPA Criteria

JPA 2.0 specification introduces a new API to define queries dynamically via construction of an object-based `javax.persistence.CriteriaQuery` instance, rather than string-based approach used in JPQL (Java Persistence Query Language). This dynamic query definition capability, referred as Criteria API, is based on the abstract persistent schema of the entities, their embedded objects and their relationships. The syntax is designed to construct a *Query Tree* whose nodes represent the semantic query elements such as projections, conditional predicates of WHERE clause or GROUP BY elements etc.

## 11.1. Constructing a CriteriaQuery

---

The `CriteriaBuilder` interface is the factory for `CriteriaQuery`. A `CriteriaBuilder` is obtained from either an `EntityManagerFactory` or an `EntityManager` as follows:

```
EntityManager em = ... ;
CriteriaBuilder queryBuilder = em.getCriteriaBuilder();
CriteriaQuery qdef = queryBuilder.createQuery();
```

The first step in constructing a query definition is specification of query roots. Query roots specify the domain objects on which the query is evaluated. Query root is an instance of the `Root<T>` interface. A query root is added to a `CriteriaQuery` by `addRoot(Class c)` method.

```
Root<Customer> customer = qdef.from(Customer.class);
```

A query domain can be further refined by joining to other domain objects. For example, for the above query definition to operate over customers and their orders, use `join(String attribute)`:

```
Root<Order> order = customer.join(customer.get(Customer_.orders));
```

where `Customer_.orders` represent a field of canonical metamodel class for `Customer`. These canonical metamodel classes are generated during compilation by processing the persistent annotation in the source code of `Customer.java`.

The condition of a query definition is set via `where(Predicate p)` where the argument designates a conditional predicate. Conditional predicates are often composed of one or more comparisons between the attribute values of the domain objects and some variable. For example, to select the `Customer` whose name is "John Doe" and has orders that are not yet delivered, you can build the predicate and set it to the query definition as:

```
qdef.where(customer.get(Customer_.name).equal("John Doe")
    .and(order.get(Order_.status).equal(OrderStatus.DELIVERED).not()));
```

The `select()` method defines the result of the query. If left unspecified, the select projection is assumed to be the root domain object. However, you can specify the selected projections explicitly as a list:

```
qdef.select(customer.get(Customer_.name), order.get(Order_.status));
```

An attribute of a domain object can also be specified by navigating via `get(String attr)`. The attribute *should* refer to a valid persistent property of the receiving domain object, however no such validation is enforced during the construction of the query definition. All validation is deferred until the query is actually executed. On the other hand, using canonical metamodel for path navigate enforces compile type checking.

## 11.2. Executing a CriteriaQuery

A `CriteriaQuery` is executed in a similar fashion to a string-based JPQL query via the `EntityManager` and `Query` interfaces.

```
EntityManager em = ...
Query query = em.createQuery(qdef);
List result = query.getResultList();
```

A query definition can use named parameters, and the parameter values are set as usual in the `Query` instance.

A [developerworks article](#) explains details and further usage of Criteria API and its OpenJPA extensions.

## 11.3. Extension to Criteria API

Criteria API has provided an alternative means to string-based JPQL to execute a query. However, JPA 2.0 specification has not explicitly specified any equivalence between a dynamically constructed `CriteriaQuery` and a JPQL string. OpenJPA provides a mechanism to convert a `CriteriaQuery` to an equivalent JPQL query string via the extended `OpenJPACriteriaQuery` API.

```
public interface OpenJPACriteriaQuery extends CriteriaQuery {
    /**
     * Gets equivalent JPQL String for the given CriteriaQuery.
     */
    public String toCQL();
}
```

## 11.4. Generation of Canonical MetaModel classes

Annotation processing tool generates source code for a metamodel class given the annotated source code of persistent entity. This tool is invoked during compilation for JDK6 compiler if OpenJPA and JPA libraries are specified in the compiler `-classpath` option *and* Annotation processor option `-Aopenjpa.metamodel=true` is specified.

```
$ javac -classpath path/to/openjpa-all.jar -Aopenjpa.metamodel=true mypackage/MyEntity.java
```

will generate source code for canonical meta-model class `mypackage.MyEntity_`. The source code is generated relative to the directory specified in `-s` option of `javac` compiler and defaulted to the current directory.

The Annotation Processor recognizes the following options specified in the command-line with `-A` (none of them are mandatory).

- `-Aopenjpa.log=TRACE|INFO|WARN|ERROR` : The logging level. Default is `WARN`.
- `-Aopenjpa.source=<n>` : where `<n>` denotes the integral number for Java source version of the generated code. Default is `6`.
- `-Aopenjpa.naming=class name` : fully-qualified name of a class implementing `org.apache.openjpa.meta.MetadataFactory` that determines the name of a meta-class given the name of the original persistent Java entity class. Defaults to `org.apache.openjpa.persistence.PersistenceMetadataFactory` which appends an underscore character (`_`) to the original Java class name.
- `-Aopenjpa.header=<url>` : A url whose content will appear as comment header to the generated file(s). Recognizes special value `ASL` for Apache Source License header as comment. By default, adds an OpenJPA proprietary text as comment block.

---

# Chapter 12. SQL Queries

JPQL is a powerful query language, but there are times when it is not enough. Maybe you're migrating a JDBC application to JPA on a strict deadline, and you don't have time to translate your existing SQL selects to JPQL. Or maybe a certain query requires database-specific SQL your JPA implementation doesn't support. Or maybe your DBA has spent hours crafting the perfect select statement for a query in your application's critical path. Whatever the reason, SQL queries can remain an essential part of an application.

You are probably familiar with executing SQL queries by obtaining a `java.sql.Connection`, using the JDBC APIs to create a `Statement`, and executing that `Statement` to obtain a `ResultSet`. And of course, you are free to continue using this low-level approach to SQL execution in your JPA applications. However, JPA also supports executing SQL queries through the `javax.persistence.Query` interface introduced in **Chapter 10, JPA Query [93]**. Using a JPA SQL query, you can retrieve either persistent objects or projections of column values. The following sections detail each use.

---

## 12.1. Creating SQL Queries

The `EntityManager` has two factory methods suitable for creating SQL queries:

```
public Query createNativeQuery(String sqlString, Class resultClass);
public Query createNativeQuery(String sqlString, String resultSetMapping);
```

The first method is used to create a new `Query` instance that will return instances of the specified class.

The second method uses a `SqlResultSetMapping` to determine the type of object or objects to return. The example below shows these methods in action.

### *Example 12.1. Creating a SQL Query*

```
EntityManager em = ...;
Query query = em.createNativeQuery("SELECT * FROM MAG", Magazine.class);
processMagazines(query.getResultList());
```

### Note

In addition to `SELECT` statements, OpenJPA supports stored procedure invocations as SQL queries. OpenJPA will assume any SQL that does not begin with the `SELECT` keyword (ignoring case) is a stored procedure call, and invoke it as such at the JDBC level.

---

## 12.2. Retrieving Persistent Objects with SQL

When you give a SQL `Query` a candidate class, it will return persistent instances of that class. At a minimum, your SQL must select the class' primary key columns, discriminator column (if mapped), and version column (also if mapped). The JPA runtime uses the values of the primary key columns to construct each result object's identity, and possibly to match it with a persistent object already in the `EntityManager`'s cache. When an object is not already cached, the implementation creates a new object to represent the current result row. It might use the discriminator column value to make sure it constructs an object of the correct subclass. Finally, the query records available version column data for use in optimistic concurrency checking, should you later change the result object and flush it back to the database.

Aside from the primary key, discriminator, and version columns, any columns you select are used to populate the persistent fields of each result object. JPA implementations will compete on how effectively they map your selected data to your persistent instance fields.

Let's make the discussion above concrete with an example. It uses the following simple mapping between a class and the database:

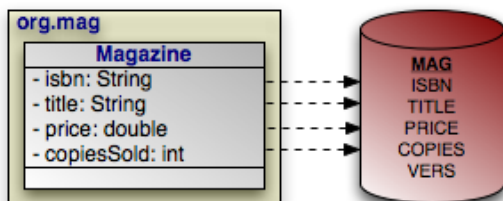

### Example 12.2. Retrieving Persistent Objects

```
Query query = em.createNativeQuery("SELECT ISBN, TITLE, PRICE, "
    + "VERS FROM MAG WHERE PRICE > 5 AND PRICE < 10", Magazine.class);
List<Magazine> results = (List<Magazine>) query.getResultList();
for (Magazine mag : results)
    processMagazine(mag);
```

The query above works as advertised, but isn't very flexible. Let's update it to take in parameters for the minimum and maximum price, so we can reuse it to find magazines in any price range:

### Example 12.3. SQL Query Parameters

```
Query query = em.createNativeQuery("SELECT ISBN, TITLE, PRICE, "
    + "VERS FROM MAG WHERE PRICE > ?1 AND PRICE < ?2", Magazine.class);

query.setParameter(1, 5d);
query.setParameter(2, 10d);

List<Magazine> results = (List<Magazine>) query.getResultList();
for (Magazine mag : results)
    processMagazine(mag);
```

Like JDBC prepared statements, SQL queries represent parameters with question marks, but are followed by an integer to represent its index.

# Chapter 13. Mapping Metadata

*Object-relational mapping* is the process of mapping entities to relational database tables. In JPA, you perform object/relational mapping through *mapping metadata*. Mapping metadata uses annotations to describe how to link your object model to your relational model.

## Note

OpenJPA offers tools to automate mapping and schema creation. See [Chapter 7, Mapping \[304\]](#) in the Reference Guide.

Throughout this chapter, we will draw on the object model introduced in [Chapter 5, Metadata \[27\]](#). We present that model again below. As we discuss various aspects of mapping metadata, we will zoom in on specific areas of the model and show how we map the object layer to the relational layer.

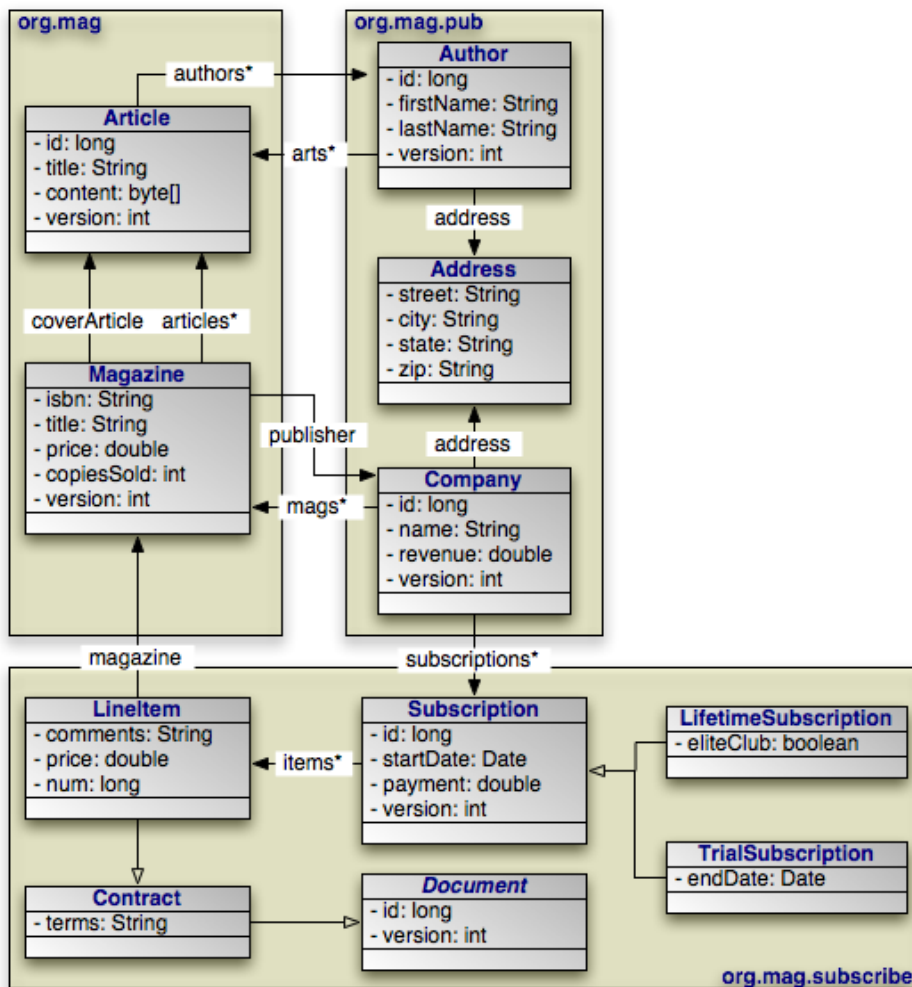

All mapping metadata is optional. Where no explicit mapping metadata is given, JPA uses the defaults defined by the specification. As we present each mapping throughout this chapter, we also describe the defaults that apply when the mapping is absent.

## Note

Mapping metadata is used primarily with schema generation. This metadata should not be relied upon for validation prior to communicating with the database. For example using the `@Column(nullable=false)` annotation does not do up front validation that the value in the entity is correct.

## 13.1. Table

The `Table` annotation specifies the table for an entity class. If you omit the `Table` annotation, base entity classes default to a table with their unqualified class name. The default table of an entity subclass depends on the inheritance strategy, as you will see in [Section 13.6, “Inheritance” \[158\]](#).

Tables have the following properties:

- `String name`: The name of the table. Defaults to the unqualified entity class name.
- `String schema`: The table's schema. If you do not name a schema, JPA uses the default schema for the database connection.
- `String catalog`: The table's catalog. If you do not name a catalog, JPA uses the default catalog for the database connection.
- `UniqueConstraint[] uniqueConstraints`: An array of unique constraints to place on the table. We cover unique constraints below. Defaults to an empty array.

The equivalent XML element is `table`. It has the following attributes, which correspond to the annotation properties above:

- `name`
- `schema`
- `catalog`

The `table` element also accepts nested `unique-constraint` elements representing unique constraints. We will detail unique constraints shortly.

Sometimes, some of the fields in a class are mapped to secondary tables. In that case, use the class' `Table` annotation to name what you consider the class' primary table. Later, we will see how to map certain fields to other tables.

The example below maps classes to tables to separate schemas. The `CONTRACT`, `SUB`, and `LINE_ITEM` tables are in the `CNTRCT` schema; all other tables are in the default schema.

### *Example 13.1. Mapping Classes*

```
package org.mag;

@Entity
@IdClass(Magazine.MagazineId.class)
@Table(name="MAG")
public class Magazine {
    ...

    public static class MagazineId {
        ...
    }
}

@Entity
@Table(name="ART")
public class Article {
```



```

    ...
}

package org.mag.pub;

@Entity
@Table(name="COMP")
public class Company {
    ...
}

@Entity
@Table(name="AUTH")
public class Author {
    ...
}

@Embeddable
public class Address {
    ...
}

package org.mag.subscribe;

@MappedSuperclass
public abstract class Document {
    ...
}

@Entity
@Table(schema="CNTRCT")
public class Contract
    extends Document {
    ...
}

@Entity
@Table(name="SUB", schema="CNTRCT")
public class Subscription {
    ...

    @Entity
    @Table(name="LINE_ITEM", schema="CNTRCT")
    public static class LineItem
        extends Contract {
        ...
    }
}

@Entity(name="Lifetime")
public class LifetimeSubscription
    extends Subscription {
    ...
}

@Entity(name="Trial")
public class TrialSubscription
    extends Subscription {
    ...
}

```

The same mapping information expressed in XML:

```

<entity-mappings xmlns="http://java.sun.com/xml/ns/persistence/orm"
  xmlns:xsi="http://www.w3.org/2001/XMLSchema-instance"
  xsi:schemaLocation="http://java.sun.com/xml/ns/persistence/orm orm_1_0.xsd"
  version="1.0">
  <mapped-superclass class="org.mag.subscribe.Document">
    ...
  </mapped-superclass>
  <entity class="org.mag.Magazine">

```

```

        <table name="MAG" />
        <id-class="org.mag.Magazine.MagazineId" />
        ...
    </entity>
    <entity class="org.mag.Article">
        <table name="ART" />
        ...
    </entity>
    <entity class="org.mag.pub.Company">
        <table name="COMP" />
        ...
    </entity>
    <entity class="org.mag.pub.Author">
        <table name="AUTH" />
        ...
    </entity>
    <entity class="org.mag.subscribe.Contract">
        <table schema="CNTRCT" />
        ...
    </entity>
    <entity class="org.mag.subscribe.Subscription">
        <table name="SUB" schema="CNTRCT" />
        ...
    </entity>
    <entity class="org.mag.subscribe.Subscription.LineItem">
        <table name="LINE_ITEM" schema="CNTRCT" />
        ...
    </entity>
    <entity class="org.mag.subscribe.LifetimeSubscription" name="Lifetime">
        ...
    </entity>
    <entity class="org.mag.subscribe.TrialSubscription" name="Trial">
        ...
    </entity>
    <embeddable class="org.mag.pub.Address">
        ...
    </embeddable>
</entity-mappings>

```

## 13.2. Unique Constraints

Unique constraints ensure that the data in a column or combination of columns is unique for each row. A table's primary key, for example, functions as an implicit unique constraint. In JPA, you represent other unique constraints with an array of `UniqueConstraint` annotations within the table annotation. The unique constraints you define are used during table creation to generate the proper database constraints, and may also be used at runtime to order `INSERT`, `UPDATE`, and `DELETE` statements. For example, suppose there is a unique constraint on the columns of field `F`. In the same transaction, you remove an object `A` and persist a new object `B`, both with the same `F` value. The JPA runtime must ensure that the SQL deleting `A` is sent to the database before the SQL inserting `B` to avoid a unique constraint violation.

`UniqueConstraint` has these properties:

- `String name`: The name of the constraint. OpenJPA will choose a name if you do not provide one, or will create an anonymous constraint.
- `String[] columnNames`: The names of the columns the constraint spans.

In XML, unique constraints are represented by nesting `unique-constraint` elements within the `table` element. Each `unique-constraint` element in turn nests `column-name` text elements to enumerate the constraint's columns.

### *Example 13.2. Defining a Unique Constraint*

The following defines a unique constraint on the `TITLE` column of the `ART` table:

```

@Entity
@Table(name="ART", uniqueConstraints=@UniqueConstraint(name="TITLE_CNSTR", columnNames="TITLE"))

```

```
public class Article {
    ...
}
```

The same metadata expressed in XML form:

```
<entity class="org.mag.Article">
  <table name="ART">
    <unique-constraint>
      <name>TITLE_CNSTR</name>
      <column-name>TITLE</column-name>
    </unique-constraint>
  </table>
  ...
</entity>
```

## 13.3. Column

In the previous section, we saw that a `UniqueConstraint` uses an array of column names. Field mappings, however, use full-fledged `Column` annotations. Column annotations have the following properties:

- `String name`: The column name. Defaults to the field name.
- `String columnDefinition`: The database-specific column type name. This property is only used by vendors that support creating tables from your mapping metadata. During table creation, the vendor will use the value of the `columnDefinition` as the declared column type. If no `columnDefinition` is given, the vendor will choose an appropriate default based on the field type combined with the column's length, precision, and scale.
- `int length`: The column length. This property is typically only used during table creation, though some vendors might use it to validate data before flushing. `CHAR` and `VARCHAR` columns typically default to a length of 255; other column types use the database default.
- `int precision`: The precision of a numeric column. This property is often used in conjunction with `scale` to form the proper column type name during table creation.
- `int scale`: The number of decimal digits a numeric column can hold. This property is often used in conjunction with `precision` to form the proper column type name during table creation.
- `boolean nullable`: Whether the column can store null values. Vendors may use this property both for table creation and at runtime; however, it is never required. Defaults to `true`.
- `boolean insertable`: By setting this property to `false`, you can omit the column from SQL `INSERT` statements. Defaults to `true`.
- `boolean updatable`: By setting this property to `false`, you can omit the column from SQL `UPDATE` statements. Defaults to `true`.
- `String table`: Sometimes you will need to map fields to tables other than the primary table. This property allows you specify that the column resides in a secondary table. We will see how to map fields to secondary tables later in the chapter.

The equivalent XML element is `column`. This element has attributes that are exactly equivalent to the `Column` annotation's properties described above:

- `name`
- `column-definition`
- `length`

- precision
- scale
- insertable
- updatable
- table

## 13.4. Identity Mapping

With our new knowledge of columns, we can map the identity fields of our entities. The diagram below now includes primary key columns for our model's tables. The primary key column for `Author` uses nonstandard type `INTEGER64`, and the `Magazine.isbn` field is mapped to a `VARCHAR(9)` column instead of a `VARCHAR(255)` column, which is the default for string fields. We do not need to point out either one of these oddities to the JPA implementation for runtime use. If, however, we want to use the JPA implementation to create our tables for us, it needs to know about any desired non-default column types. Therefore, the example following the diagram includes this data in its encoding of our mappings.

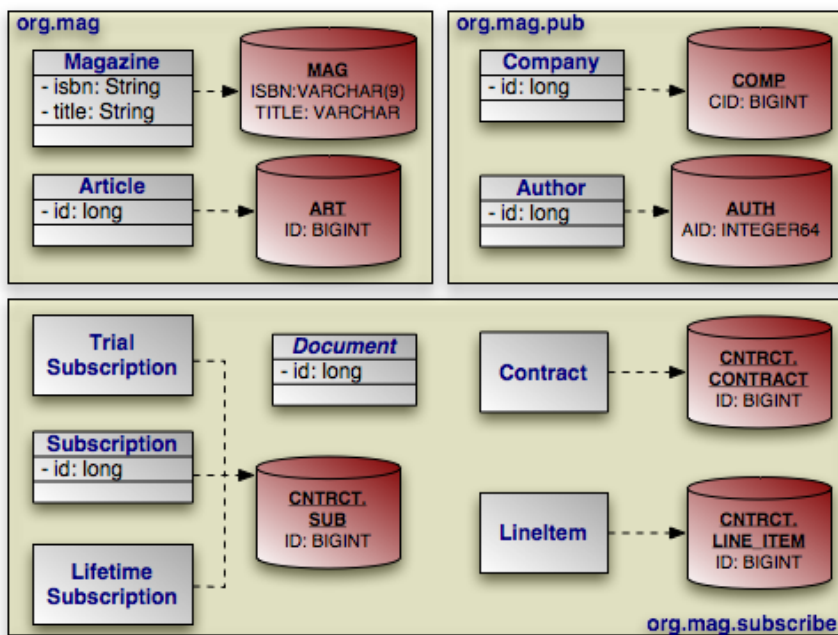

Note that many of our identity fields do not need to specify column information, because they use the default column name and type.

### Example 13.3. Identity Mapping

```
package org.mag;

@Entity
@IdClass(Magazine.MagazineId.class)
@Table(name="MAG")
public class Magazine {

    @Column(length=9)
    @Id private String isbn;
    @Id private String title;
}
```

```

    ...

    public static class MagazineId {
        ...
    }
}

@Entity
@Table(name="ART", uniqueConstraints=@Unique(columnNames="TITLE"))
public class Article {

    @Id private long id;

    ...
}

package org.mag.pub;

@Entity
@Table(name="COMP")
public class Company {

    @Column(name="CID")
    @Id private long id;

    ...
}

@Entity
@Table(name="AUTH")
public class Author {

    @Column(name="AID", columnDefinition="INTEGER64")
    @Id private long id;

    ...
}

@Embeddable
public class Address {
    ...
}

package org.mag.subscribe;

@MappedSuperclass
public abstract class Document {

    @Id
    @GeneratedValue(strategy=GenerationType.IDENTITY)
    private long id;

    ...
}

@Entity
@Table(schema="CNTRCT")
public class Contract
    extends Document {
    ...
}

@Entity
@Table(name="SUB", schema="CNTRCT")
public class Subscription {

    @Id private long id;

    ...

    @Entity
    @Table(name="LINE_ITEM", schema="CNTRCT")
    public static class LineItem
        extends Contract {
        ...
    }
}

```

```

}

@Entity(name="Lifetime")
public class LifetimeSubscription
    extends Subscription {
    ...
}

@Entity(name="Trial")
public class TrialSubscription
    extends Subscription {
    ...
}

```

The same metadata for Magazine and Company expressed in XML form:

```

<entity class="org.mag.Magazine">
  <id-class class="org.mag.Magazine.MagazineId"/>
  <table name="MAG"/>
  <attributes>
    <id name="isbn">
      <column length="9"/>
    </id>
    <id name="title"/>
    ...
  </attributes>
</entity>
<entity class="org.mag.pub.Company">
  <table name="COMP"/>
  <attributes>
    <id name="id">
      <column name="CID"/>
    </id>
    ...
  </attributes>
</entity>

```

## 13.5. Generators

One aspect of identity mapping not covered in the previous section is JPA's ability to automatically assign a value to your numeric identity fields using *generators*. We discussed the available generator types in [Section 5.2.3, “Id” \[34\]](#). Now we show you how to define named generators.

### 13.5.1. Sequence Generator

Most databases allow you to create native sequences. These are database structures that generate increasing numeric values. The `SequenceGenerator` annotation represents a named database sequence. You can place the annotation on any package, entity class, persistent field declaration (if your entity uses field access), or getter method for a persistent property (if your entity uses property access). `SequenceGenerator` has the following properties:

- `String name`: The generator name. This property is required.
- `String sequenceName`: The name of the database sequence. If you do not specify the database sequence, your vendor will choose an appropriate default.
- `int initialValue`: The initial sequence value.
- `int allocationSize`: The number of values to allocate in memory for each trip to the database. Allocating values in memory allows the JPA runtime to avoid accessing the database for every sequence request. This number also specifies the amount that the sequence value is incremented each time the sequence is accessed. Defaults to 50.

- `String schema`: The sequence's schema. If you do not name a schema, JPA uses the default schema for the database connection.

### Note

OpenJPA allows you to use one of OpenJPA's built-in generator implementations in the `sequenceName` property. You can also set the `sequenceName` to `system` to use the system sequence defined by the `open.jpa.Sequence` configuration property. See the Reference Guide's [Section 9.6, “Generators” \[344\]](#) for details.

The XML element for a sequence generator is `sequence-generator`. Its attributes mirror the above annotation's properties:

- `name`
- `sequence-name`
- `initial-value`
- `allocation-size`
- `schema`

To use a sequence generator, set your `GeneratedValue` annotation's `strategy` property to `GenerationType.SEQUENCE`, and its `generator` property to the sequence generator's declared name. Or equivalently, set your `generated-value` XML element's `strategy` attribute to `SEQUENCE` and its `generator` attribute to the generator name.

## 13.5.2. Table Generator

A `TableGenerator` refers to a database table used to store increasing sequence values for one or more entities. As with `SequenceGenerator`, you can place the `TableGenerator` annotation on any package, entity class, persistent field declaration (if your entity uses field access), or getter method for a persistent property (if your entity uses property access). `TableGenerator` has the following properties:

- `String name`: The generator name. This property is required.
- `String table`: The name of the generator table. If left unspecified, your vendor will choose a default table.
- `String schema`: The named table's schema.
- `String catalog`: The named table's catalog.
- `String pkColumnName`: The name of the primary key column in the generator table. If unspecified, your implementation will choose a default.
- `String valueColumnName`: The name of the column that holds the sequence value. If unspecified, your implementation will choose a default.
- `String pkColumnValue`: The primary key column value of the row in the generator table holding this sequence value. You can use the same generator table for multiple logical sequences by supplying different `pkColumnValue`s. If you do not specify a value, the implementation will supply a default.
- `int initialValue`: The value of the generator's first issued number.
- `int allocationSize`: The number of values to allocate in memory for each trip to the database. Allocating values in memory allows the JPA runtime to avoid accessing the database for every sequence request. This number also specifies the amount that the sequence value is incremented each time the generator table is updated. Defaults to 50.

The XML equivalent is the `table-generator` element. This element's attributes correspond exactly to the above annotation's properties:

- name
- table
- schema
- catalog
- pk-column-name
- value-column-name
- pk-column-value
- initial-value
- allocation-size

To use a table generator, set your `GeneratedValue` annotation's `strategy` property to  `GenerationType.TABLE`, and its `generator` property to the table generator's declared name. Or equivalently, set your `generated-value` XML element's `strategy` attribute to `TABLE` and its `generator` attribute to the generator name.

### 13.5.3. Example

Let's take advantage of generators in our entity model. Here are our updated mappings.

#### *Example 13.4. Generator Mapping*

```
package org.mag;

@Entity
@IdClass(Magazine.MagazineId.class)
@Table(name="MAG")
public class Magazine {

    @Column(length=9)
    @Id private String isbn;
    @Id private String title;

    ...

    public static class MagazineId {
        ...
    }
}

@Entity
@Table(name="ART", uniqueConstraints=@Unique(columnNames="TITLE"))
@SequenceGenerator(name="ArticleSeq", sequenceName="ART_SEQ")
public class Article {

    @Id
    @GeneratedValue(strategy=GenerationType.SEQUENCE, generator="ArticleSeq")
    private long id;

    ...
}

package org.mag.pub;

@Entity
@Table(name="COMP")
public class Company {

    @Column(name="CID")
    @Id private long id;
}
```



```

    ...
}

@Entity
@Table(name="AUTH")
public class Author {

    @Id
    @GeneratedValue(strategy=GenerationType.TABLE, generator="AuthorGen")
    @TableGenerator(name="AuthorGen", table="AUTH_GEN", pkColumnName="PK",
        valueColumnName="AID")
    @Column(name="AID", columnDefinition="INTEGER64")
    private long id;

    ...
}

@Embeddable
public class Address {

    ...
}

package org.mag.subscribe;

@MappedSuperclass
public abstract class Document {

    @Id
    @GeneratedValue(generate=GenerationType.IDENTITY)
    private long id;

    ...
}

@Entity
@Table(schema="CNTRCT")
public class Contract
    extends Document {

    ...
}

@Entity
@Table(name="SUB", schema="CNTRCT")
public class Subscription {

    @Id
    @GeneratedValue(strategy=GenerationType.IDENTITY)
    private long id;

    ...

    @Entity
    @Table(name="LINE_ITEM", schema="CNTRCT")
    public static class LineItem
        extends Contract {

        ...
    }
}

@Entity(name="Lifetime")
public class LifetimeSubscription
    extends Subscription {

    ...
}

@Entity(name="Trial")
public class TrialSubscription
    extends Subscription {

    ...
}

```

The same metadata for Article and Author expressed in XML form:

```

<entity class="org.mag.Article">
  <table name="ART">
    <unique-constraint>
      <column-name>TITLE</column-name>
    </unique-constraint>
  </table>
  <sequence-generator name="ArticleSeq" sequence-name="ART_SEQ"/>
  <attributes>
    <id name="id">
      <generated-value strategy="SEQUENCE" generator="ArticleSeq"/>
    </id>
    ...
  </attributes>
</entity>
<entity class="org.mag.pub.Author">
  <table name="AUTH"/>
  <attributes>
    <id name="id">
      <column name="AID" column-definition="INTEGER64"/>
      <generated-value strategy="TABLE" generator="AuthorGen"/>
      <table-generator name="AuthorGen" table="AUTH_GEN"
        pk-column-name="PK" value-column-name="AID"/>
    </id>
    ...
  </attributes>
</entity>

```

## 13.6. Inheritance

In the 1990's programmers coined the term *impedance mismatch* to describe the difficulties in bridging the object and relational worlds. Perhaps no feature of object modeling highlights the impedance mismatch better than inheritance. There is no natural, efficient way to represent an inheritance relationship in a relational database.

Luckily, JPA gives you a choice of inheritance strategies, making the best of a bad situation. The base entity class defines the inheritance strategy for the hierarchy with the `Inheritance` annotation. Inheritance has the following properties:

- `InheritanceType strategy`: Enum value declaring the inheritance strategy for the hierarchy. Defaults to `InheritanceType.SINGLE_TABLE`. We detail each of the available strategies below.

The corresponding XML element is `inheritance`, which has a single attribute:

- `strategy`: One of `SINGLE_TABLE`, `JOINED`, or `TABLE_PER_CLASS`.

The following sections describe JPA's standard inheritance strategies.

### Note

OpenJPA allows you to vary your inheritance strategy for each class, rather than forcing a single strategy per inheritance hierarchy. See [Section 7.7, “Additional JPA Mappings” \[315\]](#) in the Reference Guide for details.

### 13.6.1. Single Table

The `InheritanceType.SINGLE_TABLE` strategy maps all classes in the hierarchy to the base class' table.

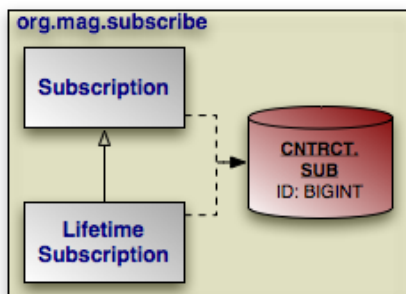

In our model, `Subscription` is mapped to the `CNRCT.SUB` table. `LifetimeSubscription`, which extends `Subscription`, adds its field data to this table as well.

### Example 13.5. Single Table Mapping

```
@Entity
@Table(name="SUB", schema="CNRCT")
@Inheritance(strategy=InheritanceType.SINGLE_TABLE)
public class Subscription {
    ...
}

@Entity(name="Lifetime")
public class LifetimeSubscription
    extends Subscription {
    ...
}
```

The same metadata expressed in XML form:

```
<entity class="org.mag.subscribe.Subscription">
  <table name="SUB" schema="CNRCT" />
  <inheritance strategy="SINGLE_TABLE" />
  ...
</entity>
<entity class="org.mag.subscribe.LifetimeSubscription">
  ...
</entity>
```

Single table inheritance is the default strategy. Thus, we could omit the `@Inheritance` annotation in the example above and get the same result.

## Note

Mapping subclass state to the superclass table is often called *flat* inheritance mapping.

### 13.6.1.1. Advantages

Single table inheritance mapping is the fastest of all inheritance models, since it never requires a join to retrieve a persistent instance from the database. Similarly, persisting or updating a persistent instance requires only a single `INSERT` or `UPDATE` statement. Finally, relations to any class within a single table inheritance hierarchy are just as efficient as relations to a base class.

### 13.6.1.2. Disadvantages

The larger the inheritance model gets, the "wider" the mapped table gets, in that for every field in the entire inheritance hierarchy, a column must exist in the mapped table. This may have undesirable consequence on the database size, since a wide or deep inheritance hierarchy will result in tables with many mostly-empty columns.

### 13.6.2. Joined

The `InheritanceType.JOINED` strategy uses a different table for each class in the hierarchy. Each table only includes state declared in its class. Thus to load a subclass instance, the JPA implementation must read from the subclass table as well as the table of each ancestor class, up to the base entity class.

#### Note

Using joined subclass tables is also called *vertical* inheritance mapping.

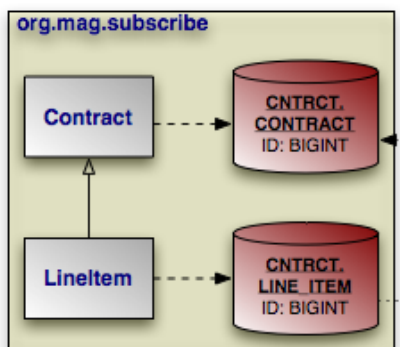

`PrimaryKeyJoinColumn` annotations tell the JPA implementation how to join each subclass table record to the corresponding record in its direct superclass table. In our model, the `LINE_ITEM.ID` column joins to the `CONTRACT.ID` column. The `PrimaryKeyJoinColumn` annotation has the following properties:

- `String name`: The name of the subclass table column. When there is a single identity field, defaults to that field's column name.
- `String referencedColumnName`: The name of the superclass table column this subclass table column joins to. When there is a single identity field, defaults to that field's column name.
- `String columnDefinition`: This property has the same meaning as the `columnDefinition` property on the `Column` annotation, described in [Section 13.3, “Column” \[151\]](#).

The XML equivalent is the `primary-key-join-column` element. Its attributes mirror the annotation properties described above:

- `name`
- `referenced-column-name`
- `column-definition`

The example below shows how we use `InheritanceTable.JOINED` and a primary key join column to map our sample model according to the diagram above. Note that a primary key join column is not strictly needed, because there is only one identity column, and the subclass table column has the same name as the superclass table column. In this situation, the defaults suffice. However, we include the primary key join column for illustrative purposes.

**Example 13.6. Joined Subclass Tables**

```

@Entity
@Table(schema="CNTRCT")
@Inheritance(strategy=InheritanceType.JOINED)
public class Contract
    extends Document {
    ...
}

public class Subscription {
    ...

    @Entity
    @Table(name="LINE_ITEM", schema="CNTRCT")
    @PrimaryKeyJoinColumn(name="ID", referencedColumnName="ID")
    public static class LineItem
        extends Contract {
        ...
    }
}

```

The same metadata expressed in XML form:

```

<entity class="org.mag.subscribe.Contract">
  <table schema="CNTRCT"/>
  <inheritance strategy="JOINED"/>
  ...
</entity>
<entity class="org.mag.subscribe.Subscription.LineItem">
  <table name="LINE_ITEM" schema="CNTRCT"/>
  <primary-key-join-column name="ID" referenced-column-name="PK"/>
  ...
</entity>

```

When there are multiple identity columns, you must define multiple `PrimaryKeyJoinColumns` using the aptly-named `PrimaryKeyJoinColumns` annotation. This annotation's value is an array of `PrimaryKeyJoinColumn`s. We could rewrite `LineItem`'s mapping as:

```

@Entity
@Table(name="LINE_ITEM", schema="CNTRCT")
@PrimaryKeyJoinColumns({
    @PrimaryKeyJoinColumn(name="ID", referencedColumnName="ID")
})
public static class LineItem
    extends Contract {
    ...
}

```

In XML, simply list as many `primary-key-join-column` elements as necessary.

### 13.6.2.1. Advantages

The joined strategy has the following advantages:

1. Using joined subclass tables results in the most *normalized* database schema, meaning the schema with the least spurious or redundant data.

- As more subclasses are added to the data model over time, the only schema modification that needs to be made is the addition of corresponding subclass tables in the database (rather than having to change the structure of existing tables).
- Relations to a base class using this strategy can be loaded through standard joins and can use standard foreign keys, as opposed to the machinations required to load polymorphic relations to table-per-class base types, described below.

### 13.6.2.2. Disadvantages

Aside from certain uses of the table-per-class strategy described below, the joined strategy is often the slowest of the inheritance models. Retrieving any subclass requires one or more database joins, and storing subclasses requires multiple `INSERT` or `UPDATE` statements. This is only the case when persistence operations are performed on subclasses; if most operations are performed on the least-derived persistent superclass, then this mapping is very fast.

#### Note

When executing a select against a hierarchy that uses joined subclass table inheritance, you must consider how to load subclass state. [Section 5.8, “Eager Fetching” \[294\]](#) in the Reference Guide describes OpenJPA's options for efficient data loading.

### 13.6.3. Table Per Class

Like the `JOINED` strategy, the `InheritanceType.TABLE_PER_CLASS` strategy uses a different table for each class in the hierarchy. Unlike the `JOINED` strategy, however, each table includes all state for an instance of the corresponding class. Thus to load a subclass instance, the JPA implementation must only read from the subclass table; it does not need to join to superclass tables.

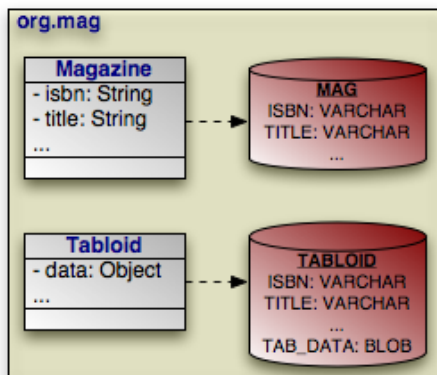

Suppose that our sample model's `Magazine` class has a subclass `Tabloid`. The classes are mapped using the table-per-class strategy, as in the diagram above. In a table-per-class mapping, `Magazine`'s table `MAG` contains all state declared in the base `Magazine` class. `Tabloid` maps to a separate table, `TABLOID`. This table contains not only the state declared in the `Tabloid` subclass, but all the base class state from `Magazine` as well. Thus the `TABLOID` table would contain columns for `isbn`, `title`, and other `Magazine` fields. These columns would default to the names used in `Magazine`'s mapping metadata. [Section 13.8.3, “Embedded Mapping” \[179\]](#) will show you how to use `AttributeOverrides` and `AssociationOverrides` to override superclass field mappings.

#### Example 13.7. Table Per Class Mapping

```

@Entity
@Table(name="MAG")
@Inheritance(strategy=InheritanceType.TABLE_PER_CLASS)
public class Magazine {
    ...
}

@Entity
@Table(name="TABLOID")
public class Tabloid
    extends Magazine {
    ...
}

```

And the same classes in XML:

```

<entity class="org.mag.Magazine">
  <table name="MAG"/>
  <inheritance strategy="TABLE_PER_CLASS"/>
  ...
</entity>
<entity class="org.mag.Tabloid">
  <table name="TABLOID"/>
  ...
</entity>

```

### 13.6.3.1. Advantages

The table-per-class strategy is very efficient when operating on instances of a known class. Under these conditions, the strategy never requires joining to superclass or subclass tables. Reads, joins, inserts, updates, and deletes are all efficient in the absence of polymorphic behavior. Also, as in the joined strategy, adding additional classes to the hierarchy does not require modifying existing class tables.

### 13.6.3.2. Disadvantages

Polymorphic relations to non-leaf classes in a table-per-class hierarchy have many limitations. When the concrete subclass is not known, the related object could be in any of the subclass tables, making joins through the relation impossible. This ambiguity also affects identity lookups and queries; these operations require multiple SQL SELECTs (one for each possible subclass), or a complex UNION.

#### Note

**Section 7.8.1, “Table Per Class” [328]** in the Reference Guide describes the limitations OpenJPA places on table-per-class mapping.

## 13.6.4. Putting it All Together

Now that we have covered JPA's inheritance strategies, we can update our mapping document with inheritance information. Here is the complete model:

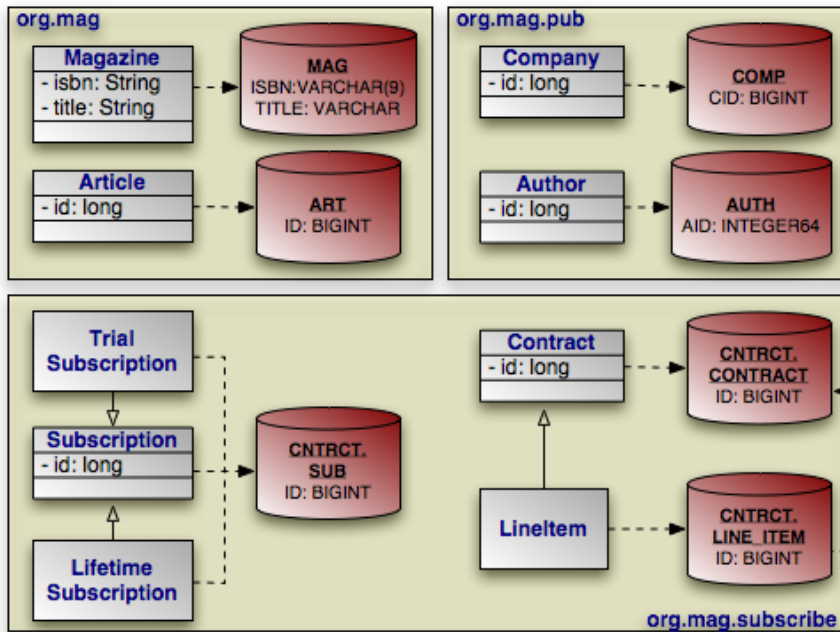

And here is the corresponding mapping metadata:

**Example 13.8. Inheritance Mapping**

```

package org.mag;

@Entity
@IdClass(Magazine.MagazineId.class)
@Table(name="MAG")
public class Magazine {

    @Column(length=9)
    @Id private String isbn;
    @Id private String title;

    ...

    public static class MagazineId {
        ...
    }
}

@Entity
@Table(name="ART", uniqueConstraints=@Unique(columnNames="TITLE"))
@SequenceGenerator(name="ArticleSeq", sequenceName="ART_SEQ")
public class Article {

    @Id
    @GeneratedValue(strategy=GenerationType.SEQUENCE, generator="ArticleSeq")
    private long id;

    ...
}

package org.mag.pub;

@Entity
@Table(name="COMP")
public class Company {

```



```

        @Column(name="CID")
        @Id private long id;

        ...
    }

@Entity
@Table(name="AUTH")
public class Author {

    @Id
    @GeneratedValue(strategy=GenerationType.TABLE, generator="AuthorGen")
    @TableGenerator(name="AuthorGen", table="AUTH_GEN", pkColumnName="PK",
        valueColumnName="AID")
    @Column(name="AID", columnDefinition="INTEGER64")
    private long id;

    ...
}

@Embeddable
public class Address {
    ...
}

package org.mag.subscribe;

@MappedSuperclass
public abstract class Document {

    @Id
    @GeneratedValue(strategy=GenerationType.IDENTITY)
    private long id;

    ...
}

@Entity
@Table(schema="CNTRCT")
@Inheritance(strategy=InheritanceType.JOINED)
public class Contract
    extends Document {
    ...
}

@Entity
@Table(name="SUB", schema="CNTRCT")
@Inheritance(strategy=InheritanceType.SINGLE_TABLE)
public class Subscription {

    @Id
    @GeneratedValue(strategy=GenerationType.IDENTITY)
    private long id;

    ...

    @Entity
    @Table(name="LINE_ITEM", schema="CNTRCT")
    @PrimaryKeyJoinColumn(name="ID", referencedColumnName="ID")
    public static class LineItem
        extends Contract {
        ...
    }
}

@Entity(name="Lifetime")
public class LifetimeSubscription
    extends Subscription {
    ...
}

@Entity(name="Trial")
public class TrialSubscription
    extends Subscription {
    ...
}

```

}

The same metadata expressed in XML form:

```

<entity-mappings xmlns="http://java.sun.com/xml/ns/persistence/orm"
  xmlns:xsi="http://www.w3.org/2001/XMLSchema-instance"
  xsi:schemaLocation="http://java.sun.com/xml/ns/persistence/orm orm_1_0.xsd"
  version="1.0">
  <mapped-superclass class="org.mag.subscribe.Document">
    <attributes>
      <id name="id">
        <generated-value strategy="IDENTITY"/>
      </id>
      ...
    </attributes>
  </mapped-superclass>
  <entity class="org.mag.Magazine">
    <table name="MAG"/>
    <id-class="org.mag.Magazine.MagazineId"/>
    <attributes>
      <id name="isbn">
        <column length="9"/>
      </id>
      <id name="title"/>
      ...
    </attributes>
  </entity>
  <entity class="org.mag.Article">
    <table name="ART">
      <unique-constraint>
        <column-name>TITLE</column-name>
      </unique-constraint>
    </table>
    <sequence-generator name="ArticleSeq" sequence-name="ART_SEQ"/>
    <attributes>
      <id name="id">
        <generated-value strategy="SEQUENCE" generator="ArticleSeq"/>
      </id>
      ...
    </attributes>
  </entity>
  <entity class="org.mag.pub.Company">
    <table name="COMP"/>
    <attributes>
      <id name="id">
        <column name="CID"/>
      </id>
      ...
    </attributes>
  </entity>
  <entity class="org.mag.pub.Author">
    <table name="AUTH"/>
    <attributes>
      <id name="id">
        <column name="AID" column-definition="INTEGER64"/>
        <generated-value strategy="TABLE" generator="AuthorGen"/>
        <table-generator name="AuthorGen" table="AUTH_GEN"
          pk-column-name="PK" value-column-name="AID"/>
      </id>
      ...
    </attributes>
  </entity>
  <entity class="org.mag.subscribe.Contract">
    <table schema="CNTRCT"/>
    <inheritance strategy="JOINED"/>
    <attributes>
      ...
    </attributes>
  </entity>
  <entity class="org.mag.subscribe.Subscription">
    <table name="SUB" schema="CNTRCT"/>
    <inheritance strategy="SINGLE_TABLE"/>
    <attributes>

```

```

        <id name="id">
            <generated-value strategy="IDENTITY"/>
        </id>
        ...
    </attributes>
</entity>
<entity class="org.mag.subscribe.Subscription.LineItem">
    <table name="LINE_ITEM" schema="CNTRCT"/>
    <primary-key-join-column name="ID" referenced-column-name="PK"/>
    ...
</entity>
<entity class="org.mag.subscribe.LifetimeSubscription" name="Lifetime">
    ...
</entity>
<entity class="org.mag.subscribe.TrialSubscription" name="Trial">
    ...
</entity>
</entity-mappings>

```

## 13.7. Discriminator

The **single table** inheritance strategy results in a single table containing records for two or more different classes in an inheritance hierarchy. Similarly, using the **joined** strategy results in the superclass table holding records for superclass instances as well as for the superclass state of subclass instances. When selecting data, JPA needs a way to differentiate a row representing an object of one class from a row representing an object of another. That is the job of the *discriminator* column.

The discriminator column is always in the table of the base entity. It holds a different value for records of each class, allowing the JPA runtime to determine what class of object each row represents.

The `DiscriminatorColumn` annotation represents a discriminator column. It has these properties:

- `String name`: The column name. Defaults to `DTYPE`.
- `length`: For string discriminator values, the length of the column. Defaults to 31.
- `String columnDefinition`: This property has the same meaning as the `columnDefinition` property on the `Column` annotation, described in [Section 13.3, “Column” \[151\]](#).
- `DiscriminatorType discriminatorType`: Enum value declaring the discriminator strategy of the hierarchy.

The corresponding XML element is `discriminator-column`. Its attributes mirror the annotation properties above:

- `name`
- `length`
- `column-definition`
- `discriminator-type`: One of `STRING`, `CHAR`, or `INTEGER`.

The `DiscriminatorValue` annotation specifies the discriminator value for each class. Though this annotation's value is always a string, the implementation will parse it according to the `DiscriminatorColumn`'s `discriminatorType` property above. The type defaults to `DiscriminatorType.STRING`, but may be `DiscriminatorType.CHAR` or `DiscriminatorType.INTEGER`. If you do not specify a `DiscriminatorValue`, the provider will choose an appropriate default.

The corresponding XML element is `discriminator-value`. The text within this element is parsed as the discriminator value.

### Note

OpenJPA assumes your model employs a discriminator column if any of the following are true:

1. The base entity explicitly declares an inheritance type of `SINGLE_TABLE`.
2. The base entity sets a discriminator value.
3. The base entity declares a discriminator column.

Only `SINGLE_TABLE` inheritance hierarchies require a discriminator column and values. `JOINED` hierarchies can use a discriminator to make some operations more efficient, but do not require one. `TABLE_PER_CLASS` hierarchies have no use for a discriminator.

OpenJPA defines additional discriminator strategies; see [Section 7.7, “Additional JPA Mappings” \[315\]](#) in the Reference Guide for details. OpenJPA also supports final entity classes. OpenJPA does not use a discriminator on final classes.

We can now translate our newfound knowledge of JPA discriminators into concrete JPA mappings. We first extend our diagram with discriminator columns:

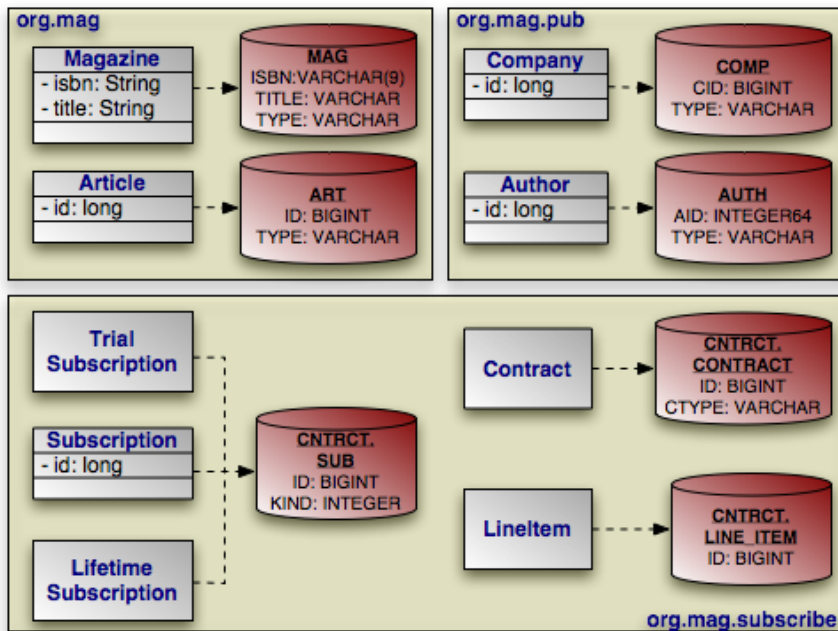

Next, we present the updated mapping document. Notice that in this version, we have removed explicit inheritance annotations when the defaults sufficed. Also, notice that entities using the default `DTYPE` discriminator column mapping do not need an explicit `DiscriminatorColumn` annotation.

### Example 13.9. Discriminator Mapping

```
package org.mag;

@Entity
@IdClass(Magazine.MagazineId.class)
@Table(name="MAG")
@DiscriminatorValue("Mag")
public class Magazine {

    @Column(length=9)
    @Id private String isbn;
    @Id private String title;
    ...
}
```

```

    public static class MagazineId {
        ...
    }
}

@Entity
@Table(name="ART", uniqueConstraints=@Unique(columnNames="TITLE"))
@SequenceGenerator(name="ArticleSeq", sequenceName="ART_SEQ")
public class Article {

    @Id
    @GeneratedValue(strategy=GenerationType.SEQUENCE, generator="ArticleSeq")
    private long id;

    ...
}

package org.mag.pub;

@Entity
@Table(name="COMP")
public class Company {

    @Column(name="CID")
    @Id private long id;

    ...
}

@Entity
@Table(name="AUTH")
public class Author {

    @Id
    @GeneratedValue(strategy=GenerationType.TABLE, generator="AuthorGen")
    @TableGenerator(name="AuthorGen", table="AUTH_GEN", pkColumnName="PK",
        valueColumnName="AID")
    @Column(name="AID", columnDefinition="INTEGER64")
    private long id;

    ...
}

@Embeddable
public class Address {
    ...
}

package org.mag.subscribe;

@MappedSuperclass
public abstract class Document {

    @Id
    @GeneratedValue(strategy=GenerationType.IDENTITY)
    private long id;

    ...
}

@Entity
@Table(schema="CNTRCT")
@Inheritance(strategy=InheritanceType.JOINED)
@DiscriminatorColumn(name="CTYPE")
public class Contract
    extends Document {
    ...
}

@Entity
@Table(name="SUB", schema="CNTRCT")
@DiscriminatorColumn(name="KIND", discriminatorType=DiscriminatorType.INTEGER)
@DiscriminatorValue("1")
public class Subscription {

```

```

@Id
@GeneratedValue(strategy=GenerationType.IDENTITY)
private long id;

...

@Entity
@Table(name="LINE_ITEM", schema="CNTRCT")
public static class LineItem
    extends Contract {
    ...
}

@Entity(name="Lifetime")
@DiscriminatorValue("2")
public class LifetimeSubscription
    extends Subscription {
    ...
}

@Entity(name="Trial")
@DiscriminatorValue("3")
public class TrialSubscription
    extends Subscription {
    ...
}

```

The same metadata expressed in XML:

```

<entity-mappings xmlns="http://java.sun.com/xml/ns/persistence/orm"
  xmlns:xsi="http://www.w3.org/2001/XMLSchema-instance"
  xsi:schemaLocation="http://java.sun.com/xml/ns/persistence/orm orm_1_0.xsd"
  version="1.0">
  <mapped-superclass class="org.mag.subscribe.Document">
    <attributes>
      <id name="id">
        <generated-value strategy="IDENTITY"/>
      </id>
      ...
    </attributes>
  </mapped-superclass>
  <entity class="org.mag.Magazine">
    <table name="MAG"/>
    <id-class="org.mag.Magazine.MagazineId"/>
    <discriminator-value>Mag</discriminator-value>
    <attributes>
      <id name="isbn">
        <column length="9"/>
      </id>
      <id name="title"/>
      ...
    </attributes>
  </entity>
  <entity class="org.mag.Article">
    <table name="ART">
      <unique-constraint>
        <column-name>TITLE</column-name>
      </unique-constraint>
    </table>
    <sequence-generator name="ArticleSeq" sequence-name="ART_SEQ"/>
    <attributes>
      <id name="id">
        <generated-value strategy="SEQUENCE" generator="ArticleSeq"/>
      </id>
      ...
    </attributes>
  </entity>
  <entity class="org.mag.pub.Company">
    <table name="COMP"/>
    <attributes>
      <id name="id">
        <column name="CID"/>

```

```

        </id>
        ...
    </attributes>
</entity>
<entity class="org.mag.pub.Author">
    <table name="AUTH"/>
    <attributes>
        <id name="id">
            <column name="AID" column-definition="INTEGER64"/>
            <generated-value strategy="TABLE" generator="AuthorGen"/>
            <table-generator name="AuthorGen" table="AUTH_GEN"
                pk-column-name="PK" value-column-name="AID"/>
        </id>
        ...
    </attributes>
</entity>
<entity class="org.mag.subscribe.Contract">
    <table schema="CNTRCT"/>
    <inheritance strategy="JOINED"/>
    <discriminator-column name="CTYPE"/>
    <attributes>
        ...
    </attributes>
</entity>
<entity class="org.mag.subscribe.Subscription">
    <table name="SUB" schema="CNTRCT"/>
    <inheritance strategy="SINGLE_TABLE"/>
    <discriminator-value>1</discriminator-value>
    <discriminator-column name="KIND" discriminator-type="INTEGER"/>
    <attributes>
        <id name="id">
            <generated-value strategy="IDENTITY"/>
        </id>
        ...
    </attributes>
</entity>
<entity class="org.mag.subscribe.Subscription.LineItem">
    <table name="LINE_ITEM" schema="CNTRCT"/>
    <primary-key-join-column name="ID" referenced-column-name="PK"/>
    ...
</entity>
<entity class="org.mag.subscribe.LifetimeSubscription" name="Lifetime">
    <discriminator-value>2</discriminator-value>
    ...
</entity>
<entity class="org.mag.subscribe.TrialSubscription" name="Trial">
    <discriminator-value>3</discriminator-value>
    ...
</entity>
</entity-mappings>

```

## 13.8. Field Mapping

The following sections enumerate the myriad of field mappings JPA supports. JPA augments the persistence metadata covered in [Chapter 5, \*Metadata\* \[27\]](#) with many new object-relational annotations. As we explore the library of standard mappings, we introduce each of these enhancements in context.

### Note

OpenJPA supports many additional field types, and allows you to create custom mappings for unsupported field types or database schemas. See the Reference Guide's [Chapter 7, \*Mapping\* \[304\]](#) for complete coverage of OpenJPA's mapping capabilities.

### 13.8.1. Basic Mapping

A *basic* field mapping stores the field value directly into a database column. The following field metadata types use basic mapping. These types were defined in [Section 5.2, “Field and Property Metadata” \[32\]](#).

- **Id** fields.
- **Version** fields.
- **Basic** fields.

In fact, you have already seen examples of basic field mappings in this chapter - the mapping of all identity fields in [Example 13.3, “Identity Mapping” \[152\]](#). As you saw in that section, to write a basic field mapping you use the `Column` annotation to describe the column the field value is stored in. We discussed the `Column` annotation in [Section 13.3, “Column” \[151\]](#). Recall that the name of the column defaults to the field name, and the type of the column defaults to an appropriate type for the field type. These defaults allow you to sometimes omit the annotation altogether.

### 13.8.1.1. LOBs

Adding the `Lob` marker annotation to a basic field signals that the data is to be stored as a LOB (Large Object). If the field holds string or character data, it will map to a CLOB (Character Large Object) database column. If the field holds any other data type, it will be stored as binary data in a BLOB (Binary Large Object) column. The implementation will serialize the Java value if needed.

The equivalent XML element is `lob`, which has no children or attributes.

#### Note

OpenJPA also supports LOB streaming. See [Section 7.7.11, “LOB Streaming” \[327\]](#) in the Reference Guide for details.

### 13.8.1.2. Enumerated

You can apply the `Enumerated` annotation to your `Enum` fields to control how they map to the database. The `Enumerated` annotation's value one of the following constants from the `EnumType` enum:

- `EnumType.ORDINAL`: The default. The persistence implementation places the ordinal value of the enum in a numeric column. This is an efficient mapping, but may break if you rearrange the Java enum declaration.
- `EnumType.STRING`: Store the name of the enum value rather than the ordinal. This mapping uses a `VARCHAR` column rather than a numeric one.

The `Enumerated` annotation is optional. Any un-annotated enumeration field defaults to `ORDINAL` mapping.

The corresponding XML element is `enumerated`. Its embedded text must be one of `STRING` or `ORIDINAL`.

### 13.8.1.3. Temporal Types

The `Temporal` annotation determines how the implementation handles your basic `java.util.Date` and `java.util.Calendar` fields at the JDBC level. The `Temporal` annotation's value is a constant from the `TemporalType` enum. Available values are:

- `TemporalType.TIMESTAMP`: The default. Use JDBC's timestamp APIs to manipulate the column data.
- `TemporalType.DATE`: Use JDBC's SQL date APIs to manipulate the column data.
- `TemporalType.TIME`: Use JDBC's time APIs to manipulate the column data.

If the `Temporal` annotation is omitted, the implementation will treat the data as a timestamp.



The corresponding XML element is `temporal`, whose text value must be one of: `TIME`, `DATE`, or `TIMESTAMP`.

### 13.8.1.4. The Updated Mappings

Below we present an updated diagram of our model and its associated database schema, followed by the corresponding mapping metadata. Note that the mapping metadata relies on defaults where possible. Also note that as a mapped superclass, `Document` can define mappings that will automatically transfer to its subclass' tables. In [Section 13.8.3, "Embedded Mapping" \[179\]](#), you will see how a subclass can override its mapped superclass' mappings.

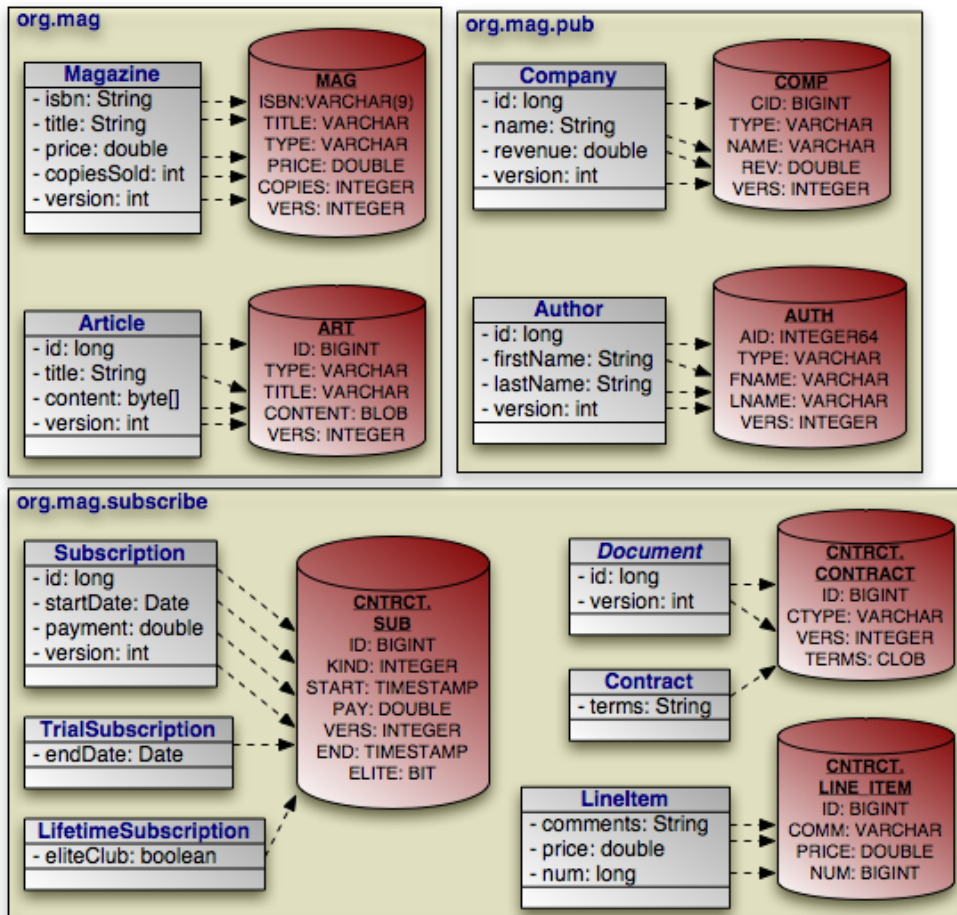

#### Example 13.10. Basic Field Mapping

```
package org.mag;

@Entity
@IdClass(Magazine.MagazineId.class)
@Table(name="MAG")
@DiscriminatorValue("Mag")
public class Magazine {

    @Column(length=9)
    @Id private String isbn;
    @Id private String title;

    @Column(name="VERS")
    @Version private int version;

    private String name;
```

```

private double price;

@Column(name="COPIES")
private int copiesSold;

...

public static class MagazineId {
    ...
}

@Entity
@Table(name="ART", uniqueConstraints=@Unique(columnNames="TITLE"))
@SequenceGenerator(name="ArticleSeq", sequenceName="ART_SEQ")
public class Article {

    @Id
    @GeneratedValue(strategy=GenerationType.SEQUENCE, generator="ArticleSeq")
    private long id;

    @Column(name="VERS")
    @Version private int version;

    private String title;
    private byte[] content;

    ...
}

package org.mag.pub;

@Entity
@Table(name="COMP")
public class Company {

    @Column(name="CID")
    @Id private long id;

    @Column(name="VERS")
    @Version private int version;

    private String name;

    @Column(name="REV")
    private double revenue;

    ...
}

@Entity
@Table(name="AUTH")
public class Author {

    @Id
    @GeneratedValue(strategy=GenerationType.TABLE, generator="AuthorGen")
    @TableGenerator(name="AuthorGen", table="AUTH_GEN", pkColumnName="PK",
        valueColumnName="AID")
    @Column(name="AID", columnDefinition="INTEGER64")
    private long id;

    @Column(name="VERS")
    @Version private int version;

    @Column(name="FNAME")
    private String firstName;

    @Column(name="LNAME")
    private String lastName;

    ...
}

@Embeddable
public class Address {
    ...
}

```

```

package org.mag.subscribe;

@MappedSuperclass
public abstract class Document {

    @Id
    @GeneratedValue(strategy=GenerationType.IDENTITY)
    private long id;

    @Column(name="VERS")
    @Version private int version;

    ...
}

@Entity
@Table(schema="CNTRCT")
@Inheritance(strategy=InheritanceType.JOINED)
@DiscriminatorColumn(name="CTYPE")
public class Contract
    extends Document {

    @Lob
    private String terms;

    ...
}

@Entity
@Table(name="SUB", schema="CNTRCT")
@DiscriminatorColumn(name="KIND", discriminatorType=DiscriminatorType.INTEGER)
@DiscriminatorValue("1")
public class Subscription {

    @Id
    @GeneratedValue(strategy=GenerationType.IDENTITY)
    private long id;

    @Column(name="VERS")
    @Version private int version;

    @Column(name="START")
    private Date startDate;

    @Column(name="PAY")
    private double payment;

    ...

    @Entity
    @Table(name="LINE_ITEM", schema="CNTRCT")
    public static class LineItem
        extends Contract {

        @Column(name="COMM")
        private String comments;

        private double price;
        private long num;
        ...
    }
}

@Entity(name="Lifetime")
@DiscriminatorValue("2")
public class LifetimeSubscription
    extends Subscription {

    @Basic(fetch=FetchType.LAZY)
    @Column(name="ELITE")
    private boolean getEliteClub() { ... }
    public void setEliteClub(boolean elite) { ... }

    ...
}

@Entity(name="Trial")

```

```

@DiscriminatorValue("3")
public class TrialSubscription
    extends Subscription {

    @Column(name="END")
    public Date getEndDate() { ... }
    public void setEndDate(Date end) { ... }

    ...
}

```

The same metadata expressed in XML:

```

<entity-mappings xmlns="http://java.sun.com/xml/ns/persistence/orm"
    xmlns:xsi="http://www.w3.org/2001/XMLSchema-instance"
    xsi:schemaLocation="http://java.sun.com/xml/ns/persistence/orm orm_1_0.xsd"
    version="1.0">
  <mapped-superclass class="org.mag.subscribe.Document">
    <attributes>
      <id name="id">
        <generated-value strategy="IDENTITY"/>
      </id>
      <version name="version">
        <column name="VERS"/>
      </version>
      ...
    </attributes>
  </mapped-superclass>
  <entity class="org.mag.Magazine">
    <table name="MAG"/>
    <id-class="org.mag.Magazine.MagazineId"/>
    <discriminator-value>Mag</discriminator-value>
    <attributes>
      <id name="isbn">
        <column length="9"/>
      </id>
      <id name="title"/>
      <basic name="name"/>
      <basic name="price"/>
      <basic name="copiesSold">
        <column name="COPIES"/>
      </basic>
      <version name="version">
        <column name="VERS"/>
      </version>
      ...
    </attributes>
  </entity>
  <entity class="org.mag.Article">
    <table name="ART">
      <unique-constraint>
        <column-name>TITLE</column-name>
      </unique-constraint>
    </table>
    <sequence-generator name="ArticleSeq", sequenceName="ART_SEQ"/>
    <attributes>
      <id name="id">
        <generated-value strategy="SEQUENCE" generator="ArticleSeq"/>
      </id>
      <basic name="title"/>
      <basic name="content"/>
      <version name="version">
        <column name="VERS"/>
      </version>
      ...
    </attributes>
  </entity>
  <entity class="org.mag.pub.Company">
    <table name="COMP"/>
    <attributes>
      <id name="id">
        <column name="CID"/>
      </id>

```

```

        <basic name="name"/>
        <basic name="revenue">
            <column name="REV"/>
        </basic>
    </attributes>
</entity>
<entity class="org.mag.pub.Author">
    <table name="AUTH"/>
    <attributes>
        <id name="id">
            <column name="AID" column-definition="INTEGER64"/>
            <generated-value strategy="TABLE" generator="AuthorGen"/>
            <table-generator name="AuthorGen" table="AUTH_GEN"
                pk-column-name="PK" value-column-name="AID"/>
        </id>
        <basic name="firstName">
            <column name="FNAME"/>
        </basic>
        <basic name="lastName">
            <column name="LNAME"/>
        </basic>
        <version name="version">
            <column name="VERS"/>
        </version>
        ...
    </attributes>
</entity>
<entity class="org.mag.subscribe.Contract">
    <table schema="CNTRCT"/>
    <inheritance strategy="JOINED"/>
    <discriminator-column name="CTYPE"/>
    <attributes>
        <basic name="terms">
            <lob/>
        </basic>
        ...
    </attributes>
</entity>
<entity class="org.mag.subscribe.Subscription">
    <table name="SUB" schema="CNTRCT"/>
    <inheritance strategy="SINGLE_TABLE"/>
    <discriminator-value>1</discriminator-value>
    <discriminator-column name="KIND" discriminator-type="INTEGER"/>
    <attributes>
        <id name="id">
            <generated-value strategy="IDENTITY"/>
        </id>
        <basic name="payment">
            <column name="PAY"/>
        </basic>
        <basic name="startDate">
            <column name="START"/>
        </basic>
        <version name="version">
            <column name="VERS"/>
        </version>
        ...
    </attributes>
</entity>
<entity class="org.mag.subscribe.Subscription.LineItem">
    <table name="LINE_ITEM" schema="CNTRCT"/>
    <primary-key-join-column name="ID" referenced-column-name="PK"/>
    <attributes>
        <basic name="comments">
            <column name="COMM"/>
        </basic>
        <basic name="price"/>
        <basic name="num"/>
        ...
    </attributes>
</entity>
<entity class="org.mag.subscribe.LifetimeSubscription" name="Lifetime">
    <discriminator-value>2</discriminator-value>
    <attributes>
        <basic name="eliteClub" fetch="LAZY">
            <column name="ELITE"/>
        </basic>
        ...
    </attributes>

```

```

    </attributes>
  </entity>
  <entity class="org.mag.subscribe.TrialSubscription" name="Trial">
    <discriminator-value>3</discriminator-value>
    <attributes>
      <basic name="endDate">
        <column name="END" />
      </basic>
      ...
    </attributes>
  </entity>
</entity-mappings>

```

## 13.8.2. Secondary Tables

Sometimes a logical record is spread over multiple database tables. JPA calls a class' declared table the *primary* table, and calls other tables that make up a logical record *secondary* tables. You can map any persistent field to a secondary table. Just write the standard field mapping, then perform these two additional steps:

1. Set the `table` attribute of each of the field's columns or join columns to the name of the secondary table.
2. Define the secondary table on the entity class declaration.

You define secondary tables with the `SecondaryTable` annotation. This annotation has all the properties of the `Table` annotation covered in [Section 13.1, “Table” \[148\]](#), plus a `pkJoinColumns` property.

The `pkJoinColumns` property is an array of `PrimaryKeyJoinColumn` dictating how to join secondary table records to their owning primary table records. Each `PrimaryKeyJoinColumn` joins a secondary table column to a primary key column in the primary table. See [Section 13.6.2, “Joined” \[160\]](#) above for coverage of `PrimaryKeyJoinColumn`'s properties.

The corresponding XML element is `secondary-table`. This element has all the attributes of the `table` element, but also accepts nested `primary-key-join-column` elements.

In the following example, we move the `Article.content` field we mapped in [Section 13.8.1, “Basic Mapping” \[171\]](#) into a joined secondary table, like so:

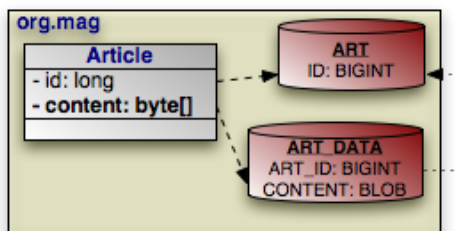

### Example 13.11. Secondary Table Field Mapping

```

package org.mag;

@Entity
@Table(name="ART")
@SecondaryTable(name="ART_DATA",
    pkJoinColumns=@PrimaryKeyJoinColumn(name="ART_ID", referencedColumnName="ID"))
public class Article {

    @Id private long id;

    @Column(table="ART_DATA")
    private byte[] content;

```

```

}
...
}

```

And in XML:

```

<entity class="org.mag.Article">
  <table name="ART" />
  <secondary-table name="ART_DATA">
    <primary-key-join-column name="ART_ID" referenced-column-name="ID" />
  </secondary-table>
  <attributes>
    <id name="id" />
    <basic name="content">
      <column table="ART_DATA" />
    </basic>
    ...
  </attributes>
</entity>

```

### 13.8.3. Embedded Mapping

Chapter 5, *Metadata* [27] describes JPA's concept of *embeddable* objects. The field values of embedded objects are stored as part of the owning record, rather than as a separate database record. Thus, instead of mapping a relation to an embeddable object as a foreign key, you map all the fields of the embeddable instance to columns in the owning field's table.

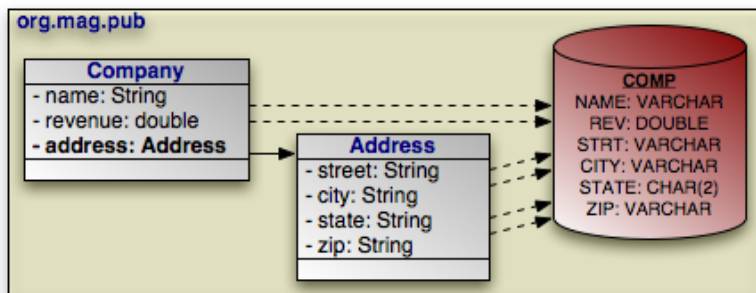

JPA defaults the embedded column names and descriptions to those of the embeddable class' field mappings. The `AttributeOverride` annotation overrides a basic embedded mapping. This annotation has the following properties:

- `String name`: The name of the embedded class' field being mapped to this class' table.
- `Column column`: The column defining the mapping of the embedded class' field to this class' table.

The corresponding XML element is `attribute-override`. It has a single `name` attribute to name the field being overridden, and a single `column` child element.

To declare multiple overrides, use the `AttributeOverrides` annotation, whose value is an array of `AttributeOverride` s. In XML, simply list multiple `attribute-override` elements in succession.

To override a many to one or one to one relationship, use the `AssociationOverride` annotation in place of `AttributeOverride`. `AssociationOverride` has the following properties:

- `String name`: The name of the embedded class' field being mapped to this class' table.
- `JoinColumn[] joinColumns`: The foreign key columns joining to the related record.

The corresponding XML element is `association-override`. It has a single `name` attribute to name the field being overridden, and one or more `join-column` child elements.

To declare multiple relation overrides, use the `AssociationOverrides` annotation, whose value is an array of `AssociationOverride`s. In XML, simply list multiple `association-override` elements in succession.

### **Example 13.12. Embedded Field Mapping**

In this example, `Company` overrides the default mapping of `Address.street` and `Address.city`. All other embedded mappings are taken from the `Address` embeddable class.

```
package org.mag.pub;

@Entity
@Table(name="COMP")
public class Company {

    @Embedded
    @AttributeOverrides({
        @AttributeOverride(name="street", column=@Column(name="STRT")),
        @AttributeOverride(name="city", column=@Column(name="ACITY"))
    })
    private Address address;

    ...
}

@Entity
@Table(name="AUTH")
public class Author {

    // use all defaults from Address class mappings
    private Address address;

    ...
}

@Embeddable
public class Address {

    private String street;
    private String city;
    @Column(columnDefinition="CHAR(2)")
    private String state;
    private String zip;
}

```

The same metadata expressed in XML:

```
<entity class="org.mag.pub.Company">
  <table name="COMP"/>
  <attributes>
    ...
    <embedded name="address">
      <attribute-override name="street">
        <column name="STRT"/>
      </attribute-override>
      <attribute-override name="city">
        <column name="ACITY"/>
      </attribute-override>
    </embedded>
  </attributes>
</entity>
<entity class="org.mag.pub.Author">
  <table name="AUTH"/>
  <attributes>

```



```

    <embedded name="address">
      <!-- use all defaults from Address -->
    </embedded>
  </attributes>
</entity>
<embeddable class="org.mag.pub.Address">
  <attributes>
    <basic name="street"/>
    <basic name="city"/>
    <basic name="state">
      <column column-definition="CHAR(2)"/>
    </basic>
    <basic name="zip"/>
  </attributes>
</embeddable>

```

You can also use attribute overrides on an entity class to override mappings defined by its mapped superclass or table-per-class superclass. The example below re-maps the `Document.version` field to the `Contract` table's `CVERSION` column.

### Example 13.13. Mapping Mapped Superclass Field

```

@MappedSuperclass
public abstract class Document {

    @Column(name="VERS")
    @Version private int version;

    ...
}

@Entity
@Table(schema="CNTRCT")
@Inheritance(strategy=InheritanceType.JOINED)
@DiscriminatorColumn(name="CTYPE")
@AttributeOverride(name="version", column=@Column(name="CVERSION"))
public class Contract
    extends Document {
    ...
}

```

The same metadata expressed in XML form:

```

<mapped-superclass class="org.mag.subscribe.Document">
  <attributes>
    <version name="version">
      <column name="VERS">
    </version>
    ...
  </attributes>
</mapped-superclass>
<entity class="org.mag.subscribe.Contract">
  <table schema="CNTRCT"/>
  <inheritance strategy="JOINED"/>
  <discriminator-column name="CTYPE"/>
  <attribute-override name="version">
    <column name="CVERSION"/>
  </attribute-override>
  <attributes>
    ...
  </attributes>
</entity>

```

## 13.8.4. Direct Relations

A direct relation is a non-embedded persistent field that holds a reference to another entity. **many to one** and **one to one** metadata field types are mapped as direct relations. Our model has three direct relations: Magazine's publisher field is a direct relation to a Company, Magazine's coverArticle field is a direct relation to Article, and the LineItem.magazine field is a direct relation to a Magazine. Direct relations are represented in the database by foreign key columns:

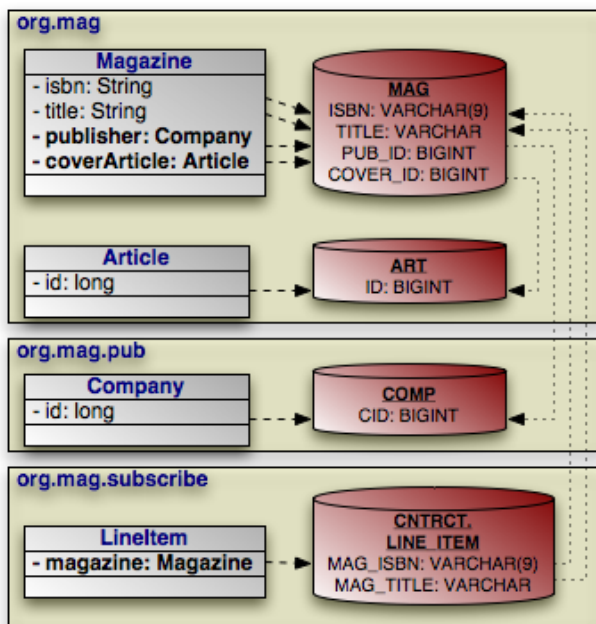

You typically map a direct relation with `JoinColumn` annotations describing how the local foreign key columns join to the primary key columns of the related record. The `JoinColumn` annotation exposes the following properties:

- `String name`: The name of the foreign key column. Defaults to the relation field name, plus an underscore, plus the name of the referenced primary key column.
- `String referencedColumnName`: The name of the primary key column being joined to. If there is only one identity field in the related entity class, the join column name defaults to the name of the identity field's column.
- `boolean unique`: Whether this column is guaranteed to hold unique values for all rows. Defaults to false.

`JoinColumn` also has the same `nullable`, `insertable`, `updatable`, `columnDefinition`, and `table` properties as the `Column` annotation. See [Section 13.3, “Column” \[151\]](#) for details on these properties.

The `join-column` element represents a join column in XML. Its attributes mirror the above annotation's properties:

- `name`
- `referenced-column-name`
- `unique`
- `nullable`
- `insertable`
- `updatable`
- `column-definition`

- table

When there are multiple columns involved in the join, as when a `LineItem` references a `Magazine` in our model, the `JoinColumns` annotation allows you to specify an array of `JoinColumn` values. In XML, simply list multiple `join-column` elements.

### Note

OpenJPA supports many non-standard joins. See [Section 7.6, “Non-Standard Joins” \[314\]](#) in the Reference Guide for details.

### Example 13.14. Direct Relation Field Mapping

```
package org.mag;

@Table(name="AUTH")
public class Magazine {

    @Column(length=9)
    @Id private String isbn;
    @Id private String title;

    @OneToOne
    @JoinColumn(name="COVER_ID" referencedColumnName="ID")
    private Article coverArticle;

    @ManyToOne
    @JoinColumn(name="PUB_ID" referencedColumnName="CID")
    private Company publisher;

    ...
}

@Table(name="ART")
public class Article {

    @Id private long id;

    ...
}

package org.mag.pub;

@Table(name="COMP")
public class Company {

    @Column(name="CID")
    @Id private long id;

    ...
}

package org.mag.subscribe;

public class Subscription {
    ...

    @Table(name="LINE_ITEM", schema="CNTRCT")
    public static class LineItem
        extends Contract {

        @ManyToOne
        @JoinColumns({
            @JoinColumn(name="MAG_ISBN" referencedColumnName="ISBN"),
            @JoinColumn(name="MAG_TITLE" referencedColumnName="TITLE")
        })
    }
}
```

```

    private Magazine magazine;

    ...
}
}

```

The same metadata expressed in XML form:

```

<entity class="org.mag.Magazine">
  <table name="MAG" />
  <id-class="org.mag.Magazine.MagazineId" />
  <attributes>
    <id name="isbn">
      <column length="9" />
    </id>
    <id name="title" />
    <one-to-one name="coverArticle">
      <join-column name="COVER_ID" referenced-column-name="ID" />
    </one-to-one>
    <many-to-one name="publisher">
      <join-column name="PUB_IC" referenced-column-name="CID" />
    </many-to-one>
    ...
  </attributes>
</entity>
<entity class="org.mag.Article">
  <table name="ART" />
  <attributes>
    <id name="id" />
    ...
  </attributes>
</entity>
<entity class="org.mag.pub.Company">
  <table name="COMP" />
  <attributes>
    <id name="id">
      <column name="CID" />
    </id>
    ...
  </attributes>
</entity>
<entity class="org.mag.subscribe.Subscription.LineItem">
  <table name="LINE_ITEM" schema="CNTRCT" />
  <primary-key-join-column name="ID" referenced-column-name="PK" />
  <attributes>
    <many-to-one name="magazine">
      <join-column name="MAG_ISBN" referenced-column-name="ISBN" />
      <join-column name="MAG_TITLE" referenced-column-name="TITLE" />
    </many-to-one>
    ...
  </attributes>
</entity>

```

When the entities in a one to one relation join on shared primary key values rather than separate foreign key columns, use the `PrimaryKeyJoinColumn(s)` annotation or `primary-key-join-column` elements in place of `JoinColumn(s)` / `join-column` elements.

## 13.8.5. Join Table

A *join table* consists of two foreign keys. Each row of a join table associates two objects together. JPA uses join tables to represent collections of entity objects: one foreign key refers back to the collection's owner, and the other refers to a collection element.

**one to many** and **many to many** metadata field types can map to join tables. Several fields in our model use join table mappings, including `Magazine.articles` and `Article.authors`.

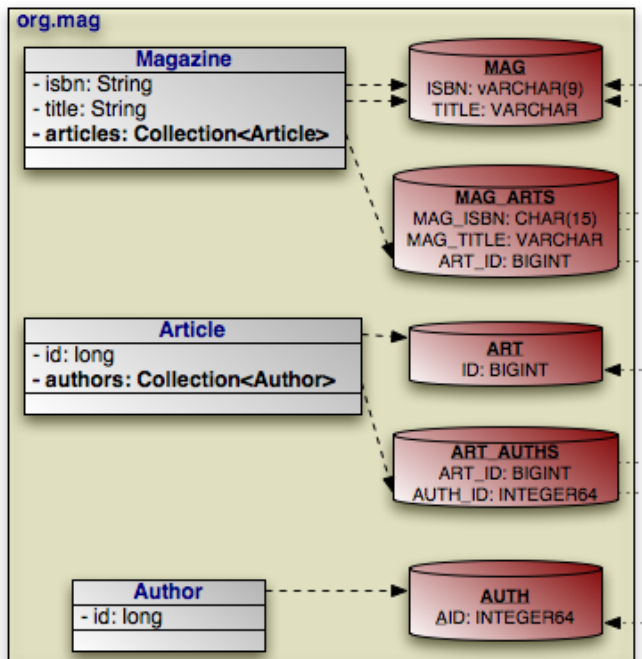

You define join tables with the `JoinTable` annotation. This annotation has the following properties:

- `String name`: Table name. If not given, the name of the table defaults to the name of the owning entity's table, plus an underscore, plus the name of the related entity's table.
- `String catalog`: Table catalog.
- `String schema`: Table schema.
- `JoinColumn[] joinColumns`: Array of `JoinColumn` showing how to associate join table records with the owning row in the primary table. This property mirrors the `pkJoinColumns` property of the `SecondaryTable` annotation in functionality. See [Section 13.8.2, “Secondary Tables” \[178\]](#) to refresh your memory on secondary tables.

If this is a bidirectional relation (see [Section 5.2.10.1, “Bidirectional Relations” \[39\]](#)), the name of a join column defaults to the inverse field name, plus an underscore, plus the referenced primary key column name. Otherwise, the join column name defaults to the field's owning entity name, plus an underscore, plus the referenced primary key column name.

- `JoinColumn[] inverseJoinColumns`: Array of `JoinColumn`s showing how to associate join table records with the records that form the elements of the collection. These join columns are used just like the join columns for direct relations, and they have the same naming defaults. Read [Section 13.8.4, “Direct Relations” \[181\]](#) for a review of direct relation mapping.

`join-table` is the corresponding XML element. It has the same attributes as the `table` element, but includes the ability to nest `join-column` and `inverse-join-column` elements as children. We have seen `join-column` elements already; `inverse-join-column` elements have the same attributes.

Here are the join table mappings for the diagram above.

### **Example 13.15. Join Table Mapping**

```
package org.mag;
```

```

@Entity
@Table(name="MAG")
public class Magazine {

    @Column(length=9)
    @Id private String isbn;
    @Id private String title;

    @OneToMany(...)
    @OrderBy
    @JoinTable(name="MAG_ARTS",
        joinColumns={
            @JoinColumn(name="MAG_ISBN", referencedColumnName="ISBN"),
            @JoinColumn(name="MAG_TITLE", referencedColumnName="TITLE")
        },
        inverseJoinColumns=@JoinColumn(name="ART_ID", referencedColumnName="ID"))
    private Collection<Article> articles;

    ...
}

@Entity
@Table(name="ART")
public class Article {

    @Id private long id;

    @ManyToMany(cascade=CascadeType.PERSIST)
    @OrderBy("lastName, firstName")
    @JoinTable(name="ART_AUTHS",
        joinColumns=@JoinColumn(name="ART_ID", referencedColumnName="ID"),
        inverseJoinColumns=@JoinColumn(name="AUTH_ID", referencedColumnName="AID"))
    private Collection<Author> authors;

    ...
}

package org.mag.pub;

@Entity
@Table(name="AUTH")
public class Author {

    @Column(name="AID", columnDefinition="INTEGER64")
    @Id private long id;

    ...
}

```

The same metadata expressed in XML:

```

<entity class="org.mag.Magazine">
  <table name="MAG"/>
  <attributes>
    <id name="isbn">
      <column length="9"/>
    </id>
    <id name="title"/>
    <one-to-many name="articles">
      <order-by/>
      <join-table name="MAG_ARTS">
        <join-column name="MAG_ISBN" referencedColumnName="ISBN"/>
        <join-column name="MAG_TITLE" referencedColumnName="TITLE"/>
        <inverse-join-column name="ART_ID" referencedColumnName="ID"/>
      </join-table>
    </one-to-many>
    ...
  </attributes>
</entity>
<entity class="org.mag.Article">
  <table name="ART"/>

```

```

<attributes>
  <id name="id"/>
  <many-to-many name="authors">
    <order-by>lastName, firstName</order-by>
    <join-table name="ART_AUTHS">
      <join-column name="ART_ID" referenced-column-name="ID" />
      <inverse-join-column name="AUTH_ID" referenced-column-name="AID" />
    </join-table>
    <cascade>
      <cascade-persist/>
    </cascade>
  </many-to-many>
  ...
</attributes>
</entity>
<entity class="org.mag.pub.Author">
  <table name="AUTH"/>
  <attributes>
    <id name="id">
      <column name="AID" column-definition="INTEGER64"/>
    </id>
    ...
  </attributes>
</entity>

```

## 13.8.6. Bidirectional Mapping

**Section 5.2.10.1, “Bidirectional Relations”** [39] introduced bidirectional relations. To map a bidirectional relation, you map one field normally using the annotations we have covered throughout this chapter. Then you use the `mappedBy` property of the other field's metadata annotation or the corresponding `mapped-by` XML attribute to refer to the mapped field. Look for this pattern in these bidirectional relations as you peruse the complete mappings below:

- `Magazine.publisher` and `Company.mags`.
- `Article.authors` and `Author.articles`.

## 13.8.7. Map Mapping

All map fields in JPA are modeled on either one to many or many to many associations. The map key is always derived from an associated entity's field. Thus map fields use the same mappings as any one to many or many to many fields, namely dedicated **join tables** or **bidirectional relations**. The only additions are the `MapKey` annotation and `map-key` element to declare the key field. We covered these additions in **Section 5.2.14, “Map Key”** [41].

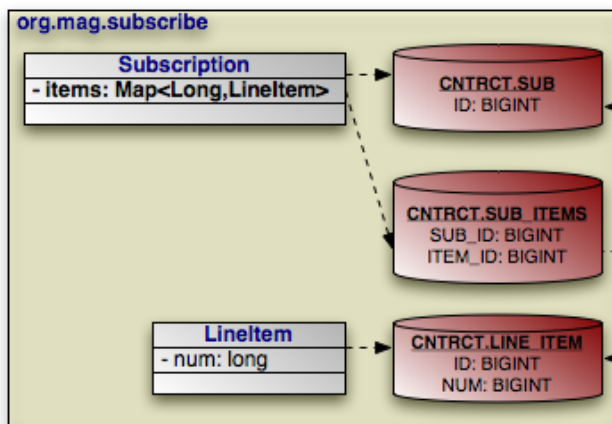

The example below maps `Subscription`'s map of `LineItems` to the `SUB_ITEMS` join table. The key for each map entry is the `LineItem`'s `num` field value.

**Example 13.16. Join Table Map Mapping**

```

package org.mag.subscribe;

@Entity
@Table(name="SUB", schema="CNTRCT")
public class Subscription {

    @OneToMany(cascade={CascadeType.PERSIST,CascadeType.REMOVE})
    @MapKey(name="num")
    @JoinTable(name="SUB_ITEMS", schema="CNTRCT",
        joinColumns=@JoinColumn(name="SUB_ID"),
        inverseJoinColumns=@JoinColumn(name="ITEM_ID"))
    private Map<Long,LineItem> items;

    ...

    @Entity
    @Table(name="LINE_ITEM", schema="CNTRCT")
    public static class LineItem
        extends Contract {

        private long num;

        ...
    }
}

```

The same metadata expressed in XML:

```

<entity class="org.mag.subscribe.Subscription">
  <table name="SUB" schema="CNTRCT"/>
  <attributes>
    ...
    <one-to-many name="items">
      <map-key name="num">
        <join-table name="SUB_ITEMS" schema="CNTRCT">
          <join-column name="SUB_ID"/>
          <inverse-join-column name="ITEM_ID"/>
        </join-table>
        <cascade>
          <cascade-persist/>
          <cascade-remove/>
        </cascade>
      </one-to-many>
    ...
  </attributes>
</entity>
<entity class="org.mag.subscribe.Subscription.LineItem">
  <table name="LINE_ITEM" schema="CNTRCT"/>
  <attributes>
    ...
    <basic name="num"/>
    ...
  </attributes>
</entity>

```

## 13.9. The Complete Mappings

We began this chapter with the goal of mapping the following object model:





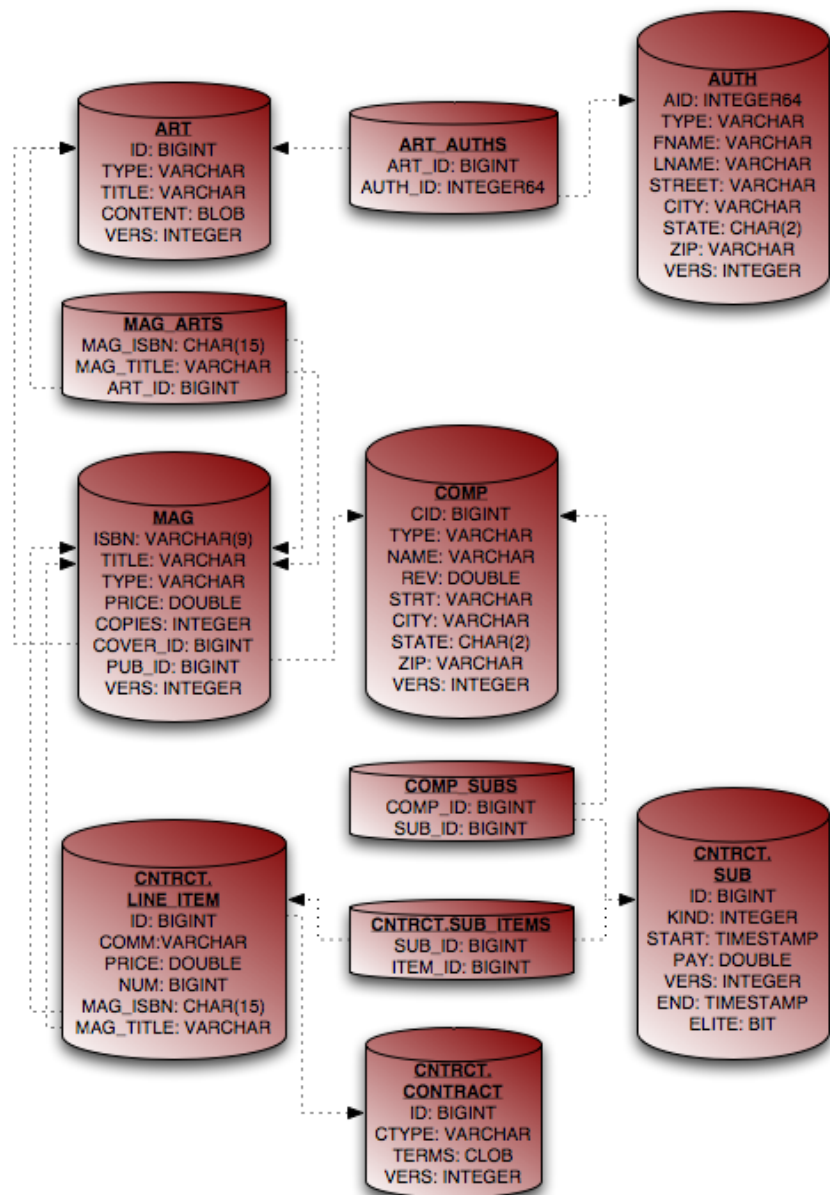

And finally, the complete entity mappings. We have trimmed the mappings to take advantage of JPA defaults where possible.

### Example 13.17. Full Entity Mappings

```
package org.mag;

@Entity
@IdClass(Magazine.MagazineId.class)
@Table(name="MAG")
@DiscriminatorValue("Mag")
public class Magazine {

    @Column(length=9)
    @Id private String isbn;
    @Id private String title;
```

```

@Column(name="VERS")
@Version private int version;

private String name;
private double price;

@Column(name="COPIES")
private int copiesSold;

@OneToOne(fetch=FetchType.LAZY,
    cascade={CascadeType.PERSIST,CascadeType.REMOVE})
@JoinColumn(name="COVER_ID")
private Article coverArticle;

@OneToMany(cascade={CascadeType.PERSIST,CascadeType.REMOVE})
@OrderBy
@JoinTable(name="MAG_ARTS",
    joinColumns={
        @JoinColumn(name="MAG_ISBN", referencedColumnName="ISBN"),
        @JoinColumn(name="MAG_TITLE", referencedColumnName="TITLE")
    },
    inverseJoinColumns=@JoinColumn(name="ART_ID"))
private Collection<Article> articles;

@ManyToOne(fetch=FetchType.LAZY, cascade=CascadeType.PERSIST)
@JoinColumn(name="PUB_ID")
private Company publisher;

@Transient private byte[] data;

...

public static class MagazineId {
    ...
}

@Entity
@Table(name="ART", uniqueConstraints=@Unique(columnNames="TITLE"))
@SequenceGenerator(name="ArticleSeq", sequenceName="ART_SEQ")
public class Article {

    @Id
    @GeneratedValue(strategy=GenerationType.SEQUENCE, generator="ArticleSeq")
    private long id;

    @Column(name="VERS")
    @Version private int version;

    private String title;
    private byte[] content;

    @ManyToMany(cascade=CascadeType.PERSIST)
    @OrderBy("lastName, firstName")
    @JoinTable(name="ART_AUTHS",
        joinColumns=@JoinColumn(name="ART_ID"),
        inverseJoinColumns=@JoinColumn(name="AUTH_ID"))
    private Collection<Author> authors;

    ...
}

package org.mag.pub;

@Entity
@Table(name="COMP")
public class Company {

    @Column(name="CID")
    @Id private long id;

    @Column(name="VERS")
    @Version private int version;

    private String name;

```

```

@Column(name="REV")
private double revenue;

@Embedded
@AttributeOverrides({
    @AttributeOverride(name="street", column=@Column(name="STRT")),
    @AttributeOverride(name="city", column=@Column(name="ACITY"))
})
private Address address;

@OneToMany(mappedBy="publisher", cascade=CascadeType.PERSIST)
private Collection<Magazine> mags;

@OneToMany(cascade=CascadeType.PERSIST,CascadeType.REMOVE)
@JoinTable(name="COMP_SUBS",
    joinColumns=@JoinColumn(name="COMP_ID"),
    inverseJoinColumns=@JoinColumn(name="SUB_ID"))
private Collection<Subscription> subscriptions;

...
}

@Entity
@Table(name="AUTH")
public class Author {

    @Id
    @GeneratedValue(strategy=GenerationType.TABLE, generator="AuthorGen")
    @TableGenerator(name="AuthorGen", tableName="AUTH_GEN", pkColumnName="PK",
        valueColumnName="AID")
    @Column(name="AID", columnDefinition="INTEGER64")
    private long id;

    @Column(name="VERS")
    @Version private int version;

    @Column(name="FNAME")
    private String firstName;

    @Column(name="LNAME")
    private String lastName;

    private Address address;

    @ManyToMany(mappedBy="authors", cascade=CascadeType.PERSIST)
    private Collection<Article> arts;

    ...
}

@Embeddable
public class Address {

    private String street;
    private String city;
    @Column(columnDefinition="CHAR(2)")
    private String state;
    private String zip;
}

package org.mag.subscribe;

@MappedSuperclass
public abstract class Document {

    @Id
    @GeneratedValue(strategy=GenerationType.IDENTITY)
    private long id;

    @Column(name="VERS")
    @Version private int version;

    ...
}

@Entity
@Table(schema="CNTRCT")

```

```

@Inheritance(strategy=InheritanceType.JOINED)
@DiscriminatorColumn(name="CTYPE")
public class Contract
    extends Document {

    @Lob
    private String terms;

    ...
}

@Entity
@Table(name="SUB", schema="CNTRCT")
@DiscriminatorColumn(name="KIND", discriminatorType=DiscriminatorType.INTEGER)
@DiscriminatorValue("1")
public class Subscription {

    @Id
    @GeneratedValue(strategy=GenerationType.IDENTITY)
    private long id;

    @Column(name="VERS")
    @Version private int version;

    @Column(name="START")
    private Date startDate;

    @Column(name="PAY")
    private double payment;

    @OneToMany(cascade={CascadeType.PERSIST,CascadeType.REMOVE})
    @MapKey(name="num")
    @JoinTable(name="SUB_ITEMS", schema="CNTRCT",
        joinColumns=@JoinColumn(name="SUB_ID"),
        inverseJoinColumns=@JoinColumn(name="ITEM_ID"))
    private Map<Long,LineItem> items;

    ...

    @Entity
    @Table(name="LINE_ITEM", schema="CNTRCT")
    public static class LineItem
        extends Contract {

        @Column(name="COMM")
        private String comments;

        private double price;
        private long num;

        @ManyToOne
        @JoinColumns({
            @JoinColumn(name="MAG_ISBN", referencedColumnName="ISBN"),
            @JoinColumn(name="MAG_TITLE", referencedColumnName="TITLE")
        })
        private Magazine magazine;
        ...
    }
}

@Entity(name="Lifetime")
@DiscriminatorValue("2")
public class LifetimeSubscription
    extends Subscription {

    @Basic(fetch=FetchType.LAZY)
    @Column(name="ELITE")
    private boolean getEliteClub() { ... }
    public void setEliteClub(boolean elite) { ... }

    ...
}

@Entity(name="Trial")
@DiscriminatorValue("3")
public class TrialSubscription
    extends Subscription {

```

```

@Column(name="END")
public Date getEndDate() { ... }
public void setEndDate(Date end) { ... }

...
}

```

The same metadata expressed in XML form:

```

<entity-mappings xmlns="http://java.sun.com/xml/ns/persistence/orm"
  xmlns:xsi="http://www.w3.org/2001/XMLSchema-instance"
  xsi:schemaLocation="http://java.sun.com/xml/ns/persistence/orm orm_1_0.xsd"
  version="1.0">
  <mapped-superclass class="org.mag.subscribe.Document">
    <attributes>
      <id name="id">
        <generated-value strategy="IDENTITY"/>
      </id>
      <version name="version">
        <column name="VERS"/>
      </version>
    </attributes>
  </mapped-superclass>
  <entity class="org.mag.Magazine">
    <table name="MAG"/>
    <id-class="org.mag.Magazine.MagazineId"/>
    <discriminator-value>Mag</discriminator-value>
    <attributes>
      <id name="isbn">
        <column length="9"/>
      </id>
      <id name="title"/>
      <basic name="name"/>
      <basic name="price"/>
      <basic name="copiesSold">
        <column name="COPIES"/>
      </basic>
      <version name="version">
        <column name="VERS"/>
      </version>
      <many-to-one name="publisher" fetch="LAZY">
        <join-column name="PUB_ID"/>
        <cascade>
          <cascade-persist/>
        </cascade>
      </many-to-one>
      <one-to-many name="articles">
        <order-by/>
        <join-table name="MAG_ARTS">
          <join-column name="MAG_ISBN" referenced-column-name="ISBN"/>
          <join-column name="MAG_TITLE" referenced-column-name="TITLE"/>
          <inverse-join-column name="ART_ID"/>
        </join-table>
        <cascade>
          <cascade-persist/>
          <cascade-remove/>
        </cascade>
      </one-to-many>
      <one-to-one name="coverArticle" fetch="LAZY">
        <join-column name="COVER_ID"/>
        <cascade>
          <cascade-persist/>
          <cascade-remove/>
        </cascade>
      </one-to-one>
      <transient name="data"/>
    </attributes>
  </entity>
  <entity class="org.mag.Article">
    <table name="ART">
      <unique-constraint>
        <column-name>TITLE</column-name>
      </unique-constraint>

```

```

</table>
<sequence-generator name="ArticleSeq", sequenceName="ART_SEQ"/>
<attributes>
  <id name="id">
    <generated-value strategy="SEQUENCE" generator="ArticleSeq"/>
  </id>
  <basic name="title"/>
  <basic name="content"/>
  <version name="version">
    <column name="VERS"/>
  </version>
  <many-to-many name="articles">
    <order-by>lastName, firstName</order-by>
    <join-table name="ART_AUTHS">
      <join-column name="ART_ID" referenced-column-name="ID"/>
      <inverse-join-column name="AUTH_ID" referenced-column-name="AID"/>
    </join-table>
  </many-to-many>
</attributes>
</entity>
<entity class="org.mag.pub.Company">
  <table name="COMP"/>
  <attributes>
    <id name="id">
      <column name="CID"/>
    </id>
    <basic name="name"/>
    <basic name="revenue">
      <column name="REV"/>
    </basic>
    <version name="version">
      <column name="VERS"/>
    </version>
    <one-to-many name="mags" mapped-by="publisher">
      <cascade>
        <cascade-persist/>
      </cascade>
    </one-to-many>
    <one-to-many name="subscriptions">
      <join-table name="COMP_SUBS">
        <join-column name="COMP_ID"/>
        <inverse-join-column name="SUB_ID"/>
      </join-table>
      <cascade>
        <cascade-persist/>
        <cascade-remove/>
      </cascade>
    </one-to-many>
    <embedded name="address">
      <attribute-override name="street">
        <column name="STRT"/>
      </attribute-override>
      <attribute-override name="city">
        <column name="ACITY"/>
      </attribute-override>
    </embedded>
  </attributes>
</entity>
<entity class="org.mag.pub.Author">
  <table name="AUTH"/>
  <attributes>
    <id name="id">
      <column name="AID" column-definition="INTEGER64"/>
      <generated-value strategy="TABLE" generator="AuthorGen"/>
      <table-generator name="AuthorGen" table="AUTH_GEN"
        pk-column-name="PK" value-column-name="AID"/>
    </id>
    <basic name="firstName">
      <column name="FNAME"/>
    </basic>
    <basic name="lastName">
      <column name="LNAME"/>
    </basic>
    <version name="version">
      <column name="VERS"/>
    </version>
    <many-to-many name="arts" mapped-by="authors">
      <cascade>

```

```

        <cascade-persist/>
      </cascade>
    </many-to-many>
    <embedded name="address"/>
  </attributes>
</entity>
<entity class="org.mag.subscribe.Contract">
  <table schema="CNTRCT"/>
  <inheritance strategy="JOINED"/>
  <discriminator-column name="CTYPE"/>
  <attributes>
    <basic name="terms">
      <lob/>
    </basic>
  </attributes>
</entity>
<entity class="org.mag.subscribe.Subscription">
  <table name="SUB" schema="CNTRCT"/>
  <inheritance strategy="SINGLE_TABLE"/>
  <discriminator-value>1</discriminator-value>
  <discriminator-column name="KIND" discriminator-type="INTEGER"/>
  <attributes>
    <id name="id">
      <generated-value strategy="IDENTITY"/>
    </id>
    <basic name="payment">
      <column name="PAY"/>
    </basic>
    <basic name="startDate">
      <column name="START"/>
    </basic>
    <version name="version">
      <column name="VERS"/>
    </version>
    <one-to-many name="items">
      <map-key name="num">
        <join-table name="SUB_ITEMS" schema="CNTRCT">
          <join-column name="SUB_ID"/>
          <inverse-join-column name="ITEM_ID"/>
        </join-table>
        <cascade>
          <cascade-persist/>
          <cascade-remove/>
        </cascade>
      </one-to-many>
    </attributes>
  </entity>
<entity class="org.mag.subscribe.Subscription.LineItem">
  <table name="LINE_ITEM" schema="CNTRCT"/>
  <attributes>
    <basic name="comments">
      <column name="COMM"/>
    </basic>
    <basic name="price"/>
    <basic name="num"/>
    <many-to-one name="magazine">
      <join-column name="MAG_ISBN" referenced-column-name="ISBN"/>
      <join-column name="MAG_TITLE" referenced-column-name="TITLE"/>
    </many-to-one>
  </attributes>
</entity>
<entity class="org.mag.subscribe.LifetimeSubscription" name="Lifetime">
  <discriminator-value>2</discriminator-value>
  <attributes>
    <basic name="eliteClub" fetch="LAZY">
      <column name="ELITE"/>
    </basic>
  </attributes>
</entity>
<entity class="org.mag.subscribe.TrialSubscription" name="Trial">
  <discriminator-value>3</discriminator-value>
  <attributes>
    <basic name="endDate">
      <column name="END"/>
    </basic>
  </attributes>
</entity>
<embeddable class="org.mag.pub.Address">

```



```
<attributes>
  <basic name="street"/>
  <basic name="city"/>
  <basic name="state">
    <column column-definition="CHAR(2)"/>
  </basic>
  <basic name="zip"/>
</attributes>
</embeddable>
</entity-mappings>
```

---

# Chapter 14. Conclusion

This concludes our overview of the JPA specification. The **OpenJPA Reference Guide** contains detailed documentation on all aspects of the OpenJPA implementation and core development tools.

---

## **Part 3. Reference Guide**

---

---

1. Introduction .....	207
1.1. Intended Audience .....	207
2. Configuration .....	208
2.1. Introduction .....	208
2.2. Runtime Configuration .....	208
2.3. Command Line Configuration .....	208
2.3.1. Code Formatting .....	209
2.4. Plugin Configuration .....	210
2.5. OpenJPA Properties .....	211
2.5.1. openjpa.AutoClear .....	211
2.5.2. openjpa.AutoDetach .....	211
2.5.3. openjpa.BrokerFactory .....	212
2.5.4. openjpa.BrokerImpl .....	212
2.5.5. openjpa.Callbacks .....	212
2.5.6. openjpa.ClassResolver .....	212
2.5.7. openjpa.Compatibility .....	213
2.5.8. openjpa.ConnectionDriverName .....	213
2.5.9. openjpa.Connection2DriverName .....	213
2.5.10. openjpa.ConnectionFactory .....	213
2.5.11. openjpa.ConnectionFactory2 .....	214
2.5.12. openjpa.ConnectionFactoryName .....	214
2.5.13. openjpa.ConnectionFactory2Name .....	214
2.5.14. openjpa.ConnectionFactoryMode .....	214
2.5.15. openjpa.ConnectionFactoryProperties .....	215
2.5.16. openjpa.ConnectionFactory2Properties .....	215
2.5.17. openjpa.ConnectionPassword .....	215
2.5.18. openjpa.Connection2Password .....	215
2.5.19. openjpa.ConnectionProperties .....	216
2.5.20. openjpa.Connection2Properties .....	216
2.5.21. openjpa.ConnectionURL .....	216
2.5.22. openjpa.Connection2URL .....	216
2.5.23. openjpa.ConnectionUserName .....	217
2.5.24. openjpa.Connection2UserName .....	217
2.5.25. openjpa.ConnectionRetainMode .....	217
2.5.26. openjpa.DataCache .....	217
2.5.27. openjpa.DataCacheManager .....	217
2.5.28. openjpa.DataCacheMode .....	218
2.5.29. openjpa.DataCacheTimeout .....	218
2.5.30. openjpa.DetachState .....	218
2.5.31. openjpa.DynamicDataStructs .....	218
2.5.32. openjpa.DynamicEnhancementAgent .....	219
2.5.33. openjpa.FetchBatchSize .....	219
2.5.34. openjpa.EncryptionProvider .....	219
2.5.35. openjpa.FetchGroups .....	220
2.5.36. openjpa.FlushBeforeQueries .....	220
2.5.37. openjpa.IgnoreChanges .....	220
2.5.38. openjpa.Id .....	220
2.5.39. openjpa.InitializeEagerly .....	220
2.5.40. openjpa.Instrumentation .....	221
2.5.41. openjpa.InverseManager .....	221
2.5.42. openjpa.LockManager .....	221
2.5.43. openjpa.LockTimeout .....	222
2.5.44. openjpa.Log .....	222
2.5.45. openjpa.ManagedRuntime .....	222

---

2.5.46. openjpa.Mapping .....	222
2.5.47. openjpa.MaxFetchDepth .....	223
2.5.48. openjpa.MetaDataFactory .....	223
2.5.49. openjpa.MetaDataRepository .....	223
2.5.50. openjpa.Multithreaded .....	223
2.5.51. openjpa.Optimistic .....	224
2.5.52. openjpa.OptimizeIdCopy .....	224
2.5.53. openjpa.OrphanedKeyAction .....	224
2.5.54. openjpa.NontransactionalRead .....	224
2.5.55. openjpa.NontransactionalWrite .....	225
2.5.56. openjpa.ProxyManager .....	225
2.5.57. openjpa.PostLoadOnMerge .....	225
2.5.58. openjpa.QueryCache .....	225
2.5.59. openjpa.QueryCompilationCache .....	226
2.5.60. openjpa.ReadLockLevel .....	226
2.5.61. openjpa.RemoteCommitProvider .....	226
2.5.62. openjpa.RestoreState .....	226
2.5.63. openjpa.RetainState .....	227
2.5.64. openjpa.RetryClassRegistration .....	227
2.5.65. openjpa.RuntimeUnenhancedClasses .....	227
2.5.66. openjpa.SavepointManager .....	228
2.5.67. openjpa.Sequence .....	228
2.5.68. openjpa.Specification .....	228
2.5.69. openjpa.TransactionMode .....	228
2.5.70. openjpa.UseTCCLinSelectNew .....	229
2.5.71. openjpa.WriteLockLevel .....	229
2.6. OpenJPA JDBC Properties .....	229
2.6.1. openjpa.jdbc.ConnectionDecorators .....	229
2.6.2. openjpa.jdbc.DBDictionary .....	230
2.6.3. openjpa.jdbc.DriverDataSource .....	230
2.6.4. openjpa.jdbc.EagerFetchMode .....	230
2.6.5. openjpa.jdbc.FetchDirection .....	230
2.6.6. openjpa.jdbc.JDBCListeners .....	231
2.6.7. openjpa.jdbc.LRSSize .....	231
2.6.8. openjpa.jdbc.MappingDefaults .....	231
2.6.9. openjpa.jdbc.MappingFactory .....	232
2.6.10. openjpa.jdbc.QuerySQLCache .....	232
2.6.11. openjpa.jdbc.ResultSetType .....	232
2.6.12. openjpa.jdbc.Schema .....	232
2.6.13. openjpa.jdbc.SchemaFactory .....	232
2.6.14. openjpa.jdbc.Schemas .....	233
2.6.15. openjpa.jdbc.SQLFactory .....	233
2.6.16. openjpa.jdbc.SubclassFetchMode .....	233
2.6.17. openjpa.jdbc.SynchronizeMappings .....	233
2.6.18. openjpa.jdbc.TransactionIsolation .....	234
2.6.19. openjpa.jdbc.UpdateManager .....	234
2.6.20. Compatibility with Specification .....	234
3. Logging and Auditing .....	236
3.1. Logging Channels .....	236
3.2. OpenJPA Logging .....	237
3.3. Disabling Logging .....	238
3.4. Log4J .....	238
3.5. Apache Commons Logging .....	238
3.5.1. JDK java.util.logging .....	239

---

3.6. SLF4J .....	239
3.7. Custom Log .....	239
3.8. OpenJPA Audit .....	240
3.8.1. Configuration .....	240
3.8.2. Developing custom auditing .....	241
4. JDBC .....	243
4.1. Using the OpenJPA DataSource .....	243
4.1.1. Optional Connection Pooling .....	243
4.1.2. Configuring the OpenJPA DataSource .....	243
4.1.3. Configuring Apache Commons DBCP .....	244
4.2. Using a Third-Party DataSource .....	244
4.2.1. Managed and XA DataSources .....	245
4.2.2. Setting the DataSource at runtime .....	245
4.2.2.1. Using different DataSources for each EntityManager .....	246
4.2.2.1.1. Benefits .....	246
4.2.2.1.2. Limitations .....	246
4.2.2.1.3. Error handling .....	246
4.3. Runtime Access to DataSource .....	247
4.4. Database Support .....	247
4.4.1. DBDictionary Properties .....	249
4.4.2. FirebirdDictionary Properties .....	259
4.4.3. MySQLDictionary Properties .....	259
4.4.4. OracleDictionary Properties .....	259
4.4.5. SybaseDictionary Properties .....	260
4.4.6. DB2 Properties .....	260
4.4.7. Delimited Identifiers Support .....	260
4.5. Setting the Transaction Isolation .....	261
4.6. Setting the SQL Join Syntax .....	261
4.7. Accessing Multiple Databases .....	262
4.8. Configuring the Use of JDBC Connections .....	262
4.9. Statement Batching .....	264
4.10. Large Result Sets .....	265
4.11. Default Schema .....	266
4.12. Schema Reflection .....	267
4.12.1. Schemas List .....	267
4.12.2. Schema Factory .....	267
4.13. Schema Tool .....	268
4.14. XML Schema Format .....	271
5. Persistent Classes .....	274
5.1. Persistent Class List .....	274
5.2. Enhancement .....	274
5.2.1. Enhancing at Build Time .....	275
5.2.2. Enhancing JPA Entities on Deployment .....	276
5.2.3. Enhancing at Runtime .....	276
5.2.4. Enhancing Dynamically at Runtime .....	276
5.2.5. Omitting the OpenJPA enhancer .....	277
5.3. Managed Interfaces .....	278
5.4. Object Identity .....	279
5.4.1. Datastore Identity .....	279
5.4.2. Entities as Identity Fields .....	279
5.4.3. Application Identity Tool .....	281
5.4.4. Autoassign / Identity Strategy Caveats .....	282
5.5. Managed Inverses .....	282
5.6. Persistent Fields .....	284

---

---

5.6.1. Restoring State .....	284
5.6.2. Typing and Ordering .....	284
5.6.3. Calendar Fields and TimeZones .....	284
5.6.4. Proxies .....	284
5.6.4.1. Smart Proxies .....	284
5.6.4.2. Large Result Set Proxies .....	285
5.6.4.3. Custom Proxies .....	286
5.6.4.4. Serialization .....	287
5.6.5. Externalization .....	287
5.6.5.1. External Values .....	290
5.7. Fetch Groups .....	290
5.7.1. Custom Fetch Groups .....	290
5.7.2. Custom Fetch Group Configuration .....	292
5.7.3. Per-field Fetch Configuration .....	293
5.7.4. Implementation Notes .....	293
5.8. Eager Fetching .....	294
5.8.1. Configuring Eager Fetching .....	295
5.8.2. Eager Fetching Considerations and Limitations .....	296
6. Metadata .....	297
6.1. Metadata Factory .....	297
6.2. Metadata Repository .....	297
6.3. Additional JPA Metadata .....	298
6.3.1. Datastore Identity .....	298
6.3.2. Surrogate Version .....	298
6.3.3. Persistent Field Values .....	298
6.3.4. Persistent Collection Fields .....	299
6.3.5. Persistent Map Fields .....	299
6.4. Metadata Extensions .....	299
6.4.1. Class Extensions .....	299
6.4.1.1. Fetch Groups .....	300
6.4.1.2. Data Cache .....	300
6.4.1.3. Detached State .....	300
6.4.2. Field Extensions .....	300
6.4.2.1. Dependent .....	300
6.4.2.2. Load Fetch Group .....	301
6.4.2.3. LRS .....	301
6.4.2.4. Inverse-Logical .....	301
6.4.2.5. Read-Only .....	301
6.4.2.6. Type .....	301
6.4.2.7. Externalizer .....	302
6.4.2.8. Factory .....	302
6.4.2.9. External Values .....	302
6.4.3. Example .....	302
6.4.4. XML extensions .....	303
7. Mapping .....	304
7.1. Forward Mapping .....	304
7.1.1. Using the Mapping Tool .....	305
7.1.2. Generating DDL SQL .....	306
7.1.3. Runtime Forward Mapping .....	306
7.2. Reverse Mapping .....	307
7.2.1. Customizing Reverse Mapping .....	309
7.3. Meet-in-the-Middle Mapping .....	311
7.4. Mapping Defaults .....	311
7.5. Mapping Factory .....	313

---

---

7.6. Non-Standard Joins .....	314
7.7. Additional JPA Mappings .....	315
7.7.1. Datastore Identity Mapping .....	315
7.7.2. Surrogate Version Mapping .....	316
7.7.3. Multi-Column Mappings .....	317
7.7.4. Join Column Attribute Targets .....	317
7.7.5. Embedded Mapping .....	317
7.7.6. Collections .....	319
7.7.6.1. Container Table .....	319
7.7.6.2. Element Join Columns .....	319
7.7.6.3. Order Column .....	320
7.7.7. One-Sided One-Many Mapping .....	320
7.7.8. Maps .....	321
7.7.8.1. Key Columns .....	321
7.7.8.2. Key Join Columns .....	321
7.7.8.3. Key Embedded Mapping .....	321
7.7.8.4. Examples .....	322
7.7.9. Indexes and Constraints .....	322
7.7.9.1. Indexes .....	323
7.7.9.2. Foreign Keys .....	323
7.7.9.3. Unique Constraints .....	323
7.7.10. XML Column Mapping .....	324
7.7.11. LOB Streaming .....	327
7.8. Mapping Limitations .....	328
7.8.1. Table Per Class .....	328
7.9. Mapping Extensions .....	328
7.9.1. Class Extensions .....	329
7.9.1.1. Subclass Fetch Mode .....	329
7.9.1.2. Strategy .....	329
7.9.1.3. Discriminator Strategy .....	329
7.9.1.4. Version Strategy .....	329
7.9.2. Field Extensions .....	329
7.9.2.1. Eager Fetch Mode .....	329
7.9.2.2. Nonpolymorphic .....	329
7.9.2.3. Class Criteria .....	330
7.9.2.4. Strategy .....	330
7.10. Custom Mappings .....	330
7.10.1. Custom Class Mapping .....	330
7.10.2. Custom Discriminator and Version Strategies .....	330
7.10.3. Custom Field Mapping .....	331
7.10.3.1. Value Handlers .....	331
7.10.3.2. Field Strategies .....	331
7.10.3.3. Configuration .....	331
7.11. Orphaned Keys .....	331
8. Deployment .....	333
8.1. Factory Deployment .....	333
8.1.1. Standalone Deployment .....	333
8.1.2. EntityManager Injection .....	333
8.2. Integrating with the Transaction Manager .....	333
8.3. XA Transactions .....	334
8.3.1. Using OpenJPA with XA Transactions .....	334
9. Runtime Extensions .....	335
9.1. Architecture .....	335
9.1.1. Broker Finalization .....	335

---



---

9.1.2. Broker Customization and Eviction .....	335
9.2. JPA Extensions .....	336
9.2.1. OpenJPAEntityManagerFactory .....	336
9.2.2. OpenJPAEntityManager .....	336
9.2.3. OpenJPAQuery .....	336
9.2.4. Extent .....	337
9.2.5. StoreCache .....	337
9.2.6. QueryResultCache .....	337
9.2.7. FetchPlan .....	337
9.2.8. OpenJPAEntityTransaction .....	337
9.2.9. OpenJPAPersistence .....	338
9.3. Object Locking .....	338
9.3.1. Configuring Default Locking .....	338
9.3.2. Configuring Lock Levels at Runtime .....	338
9.3.3. Object Locking APIs .....	339
9.3.4. Lock Manager .....	340
9.3.5. Rules for Locking Behavior .....	341
9.3.6. Known Issues and Limitations .....	341
9.4. Savepoints .....	342
9.4.1. Using Savepoints .....	342
9.4.2. Configuring Savepoints .....	343
9.5. MethodQL .....	343
9.6. Generators .....	344
9.6.1. Runtime Access .....	346
9.7. Transaction Events .....	347
9.8. Non-Relational Stores .....	347
10. Caching .....	348
10.1. Data Cache .....	348
10.1.1. Data Cache Configuration .....	348
10.1.1.1. openjpa.DataCache Configuration .....	348
10.1.1.2. Integration with JPA standard shared cache mode .....	351
10.1.1.3. Distributing instances across cache partitions .....	351
10.1.2. Data Cache Usage .....	352
10.1.2.1. Using the JPA standard Cache interface .....	352
10.1.2.2. Using the OpenJPA StoreCache extensions .....	353
10.1.3. Cache Statistics .....	354
10.1.4. Query Cache .....	355
10.1.5. Cache Extension .....	358
10.1.6. Important Notes .....	358
10.1.7. Known Issues and Limitations .....	359
10.2. Query Compilation Cache .....	359
10.3. Prepared SQL Cache .....	360
11. Encryption Provider .....	363
12. Remote and Offline Operation .....	364
12.1. Detach and Attach .....	364
12.1.1. Detach Behavior .....	364
12.1.2. Attach Behavior .....	364
12.1.3. Defining the Detached Object Graph .....	365
12.1.3.1. Detached State .....	365
12.1.3.2. Detached State Field .....	367
12.2. Remote Event Notification Framework .....	367
12.2.1. Remote Commit Provider Configuration .....	367
12.2.1.1. JMS .....	368
12.2.1.2. TCP .....	368

---

---

12.2.1.3. Common Properties .....	369
12.2.2. Customization .....	369
13. Slice: Distributed Persistence .....	370
13.1. Overview .....	370
13.2. Salient Features .....	370
13.2.1. Transparency .....	370
13.2.2. Scaling .....	370
13.2.3. Distributed Query .....	370
13.2.4. Data Distribution .....	371
13.2.5. Data Replication .....	372
13.2.6. Heterogeneous Database .....	372
13.2.7. Distributed Transaction .....	372
13.2.8. Collocation Constraint .....	373
13.3. Usage .....	373
13.3.1. How to activate Slice Runtime? .....	373
13.3.2. How to configure each database slice? .....	373
13.3.3. Implement DistributionPolicy interface .....	374
13.3.4. Implement ReplicationPolicy interface .....	375
13.4. Configuration Properties .....	375
13.4.1. Global Properties .....	375
13.4.1.1. openjpa.slice.DistributionPolicy .....	375
13.4.1.2. openjpa.slice.Lenient .....	375
13.4.1.3. openjpa.slice.Master .....	376
13.4.1.4. openjpa.slice.Names .....	376
13.4.1.5. openjpa.slice.ThreadingPolicy .....	376
13.4.1.6. openjpa.slice.TransactionPolicy .....	376
13.4.2. Per-Slice Properties .....	377
14. Third Party Integration .....	378
14.1. Apache Ant .....	378
14.1.1. Common Ant Configuration Options .....	378
14.1.2. Enhancer Ant Task .....	379
14.1.3. Application Identity Tool Ant Task .....	380
14.1.4. Mapping Tool Ant Task .....	381
14.1.5. Reverse Mapping Tool Ant Task .....	381
14.1.6. Schema Tool Ant Task .....	382
14.2. Apache Commons DBCP .....	382
14.2.1. Apache Commons DBCP Configuration Options .....	382
15. Optimization Guidelines .....	384
16. Instrumentation .....	388
16.1. Configuration .....	388
16.1.1. JMX Platform MBean Enablement .....	388
16.2. Custom Providers and Instruments .....	388

---

# Chapter 1. Introduction

OpenJPA is a JDBC-based implementation of the JPA standard. This document is a reference for the configuration and use of OpenJPA.

## 1.1. Intended Audience

---

This document is intended for OpenJPA developers. It assumes strong knowledge of Java, familiarity with the eXtensible Markup Language (XML), and an understanding of JPA. If you are not familiar with JPA, please read the **JPA Overview** before proceeding.

Certain sections of this guide cover advanced topics such as custom object-relational mapping, enterprise integration, and using OpenJPA with third-party tools. These sections assume prior experience with the relevant subject.

---

# Chapter 2. Configuration

## 2.1. Introduction

---

This chapter describes the OpenJPA configuration framework. It concludes with descriptions of all the configuration properties recognized by OpenJPA. You may want to browse these properties now, but it is not necessary. Most of them will be referenced later in the documentation as we explain the various features they apply to.

## 2.2. Runtime Configuration

---

The OpenJPA runtime includes a comprehensive system of configuration defaults and overrides:

- OpenJPA first looks for an optional `openjpa.xml` resource. OpenJPA searches for this resource in each top-level directory of your `CLASSPATH`. OpenJPA will also find the resource if you place it within a `META-INF` directory in any top-level directory of the `CLASSPATH`. The `openjpa.xml` resource contains property settings in **JPA's XML format**.
- You can customize the name or location of the above resource by specifying the correct resource path in the `openjpa.properties` System property.
- You can override any value defined in the above resource by setting the System property of the same name to the desired value.
- In JPA, the values in the standard `META-INF/persistence.xml` bootstrapping file used by the **Persistence** class at runtime override the values in the above resource, as well as any System property settings. The `Map` passed to `Persistence.createEntityManagerFactory` at runtime also overrides previous settings, including properties defined in `persistence.xml`.
- In JPA, The `Map` passed to the methods defined in the `Query` and `EntityManager` interfaces at runtime also overrides previous settings, including properties defined in `persistence.xml`. The `Map` is in effect only during the method invocation.
- When using JCA deployment the `config-property` values in your `ra.xml` file override other settings.
- All OpenJPA command-line tools accept flags that allow you to specify the configuration resource to use, and to override any property. **Section 2.3, “Command Line Configuration” [208]** describes these flags.

### Note

Internally, the OpenJPA runtime environment and development tools manipulate property settings through a general **Configuration** interface, and in particular its **OpenJPAConfiguration** and **JDBCCConfiguration** subclasses. For advanced customization, OpenJPA's extended runtime interfaces and its development tools allow you to access these interfaces directly. See the **Javadoc** for details.

## 2.3. Command Line Configuration

---

OpenJPA development tools share the same set of configuration defaults and overrides as the runtime system. They also allow you to specify property values on the command line:

- `-properties/-p <configuration file or resource>`: Use the `-properties` flag, or its shorter `-p` form, to specify a configuration file to use. Note that OpenJPA always searches the default file locations described above, so this flag is only needed when you do not have a default resource in place, or when you wish to override the defaults. The given value can

be the path to a file, or the resource name of a file somewhere in the CLASSPATH. OpenJPA will search the given location as well as the location prefixed by `META-INF/`. Thus, to point an OpenJPA tool at `META-INF/my-persistence.xml`, you can use:

```
<tool> -p my-persistence.xml
```

If you want to run a tool against just one particular persistence unit in a configuration file, you can do so by specifying an anchor along with the resource. If you do not specify an anchor, the tools will run against all the persistence units defined within the specified resource, or the default resource if none is specified. If the persistence unit is defined within the default resource location, then you can just specify the raw anchor itself:

```
<tool> -p my-persistence.xml#sales-persistence-unit
<tool> -p #invoice-persistence-unit
```

- `-<property name> <property value>`: Any configuration property that you can specify in a configuration file can be overridden with a command line flag. The flag name is always the last token of the corresponding property name, with the first letter in either upper or lower case. For example, to override the `openjpa.ConnectionUserName` property, you could pass the `-connectionUserName <value>` flag to any tool. Values set this way override both the values in the configuration file and values set via System properties.

## 2.3.1. Code Formatting

Some OpenJPA development tools generate Java code. These tools share a common set of command-line flags for formatting their output to match your coding style. All code formatting flags can begin with either the `codeFormat` or `cf` prefix.

- `-codeFormat./-cf.tabSpaces <spaces>`: The number of spaces that make up a tab, or 0 to use tab characters. Defaults to using tab characters.
- `-codeFormat./-cf.spaceBeforeParen <true/t | false/f>`: Whether or not to place a space before opening parentheses on method calls, if statements, loops, etc. Defaults to `false`.
- `-codeFormat./-cf.spaceInParen <true/t | false/f>`: Whether or not to place a space within parentheses; i.e. `method( arg) .` Defaults to `false`.
- `-codeFormat./-cf.braceOnSameLine <true/t | false/f>`: Whether or not to place opening braces on the same line as the declaration that begins the code block, or on the next line. Defaults to `true`.
- `-codeFormat./-cf.braceAtSameTabLevel <true/t | false/f>`: When the `braceOnSameLine` option is disabled, you can choose whether to place the brace at the same tab level of the contained code. Defaults to `false`.
- `-codeFormat./-cf.scoreBeforeFieldName <true/t | false/f>`: Whether to prefix an underscore to names of private member variables. Defaults to `false`.
- `-codeFormat./-cf.linesBetweenSections <lines>`: The number of lines to skip between sections of code. Defaults to 1.

### *Example 2.1. Code Formatting with the Application Id Tool*

```
java org.apache.openjpa.enhance.ApplicationIdTool -cf.spaceBeforeParen true -cf.tabSpaces 4
```

## 2.4. Plugin Configuration

Because OpenJPA is a highly customizable environment, many configuration properties relate to the creation and configuration of system plugins. Plugin properties have a syntax very similar to that of Java annotations. They allow you to specify both what class to use for the plugin and how to configure the public fields or bean properties of the instantiated plugin instance. The easiest way to describe the plugin syntax is by example:

OpenJPA has a pluggable L2 caching mechanism that is controlled by the `openjpa.DataCache` configuration property. Suppose that you have created a new class, `com.xyz.MyDataCache`, that you want OpenJPA to use for caching. You've made instances of `MyDataCache` configurable via two methods, `setCacheSize(int size)` and `setRemoteHost(String host)`. The sample below shows how you would tell OpenJPA to use an instance of your custom plugin with a max size of 1000 and a remote host of `cacheserver`.

```
<property name="openjpa.DataCache"
  value="com.xyz.MyDataCache(CacheSize=1000, RemoteHost=cacheserver)"/>
```

As you can see, plugin properties take a class name, followed by a comma-separated list of values for the plugin's public fields or bean properties in parentheses. OpenJPA will match each named property to a field or setter method in the instantiated plugin instance, and set the field or invoke the method with the given value (after converting the value to the right type, of course). The first letter of the property names can be in either upper or lower case. The following would also have been valid:

```
com.xyz.MyDataCache(cacheSize=1000, remoteHost=cacheserver)
```

If you do not need to pass any property settings to a plugin, you can just name the class to use:

```
com.xyz.MyDataCache
```

Similarly, if the plugin has a default class that you do not want to change, you can simply specify a list of property settings, without a class name. For example, OpenJPA's query cache companion to the data cache has a default implementation suitable to most users, but you still might want to change the query cache's size. It has a `CacheSize` property for this purpose:

```
CacheSize=1000
```

Finally, many of OpenJPA's built-in options for plugins have short alias names that you can use in place of the full class name. The data cache property, for example, has an available alias of `true` for the standard cache implementation. The property value simply becomes:

```
true
```

The standard cache implementation class also has a `CacheSize` property, so to use the standard implementation and configure the size, specify:

```
true(CacheSize=1000)
```

The remainder of this chapter reviews the set of configuration properties OpenJPA recognizes.

## 2.5. OpenJPA Properties

OpenJPA defines many configuration properties. Most of these properties are provided for advanced users who wish to customize OpenJPA's behavior; the majority of developers can omit them. The following properties apply to any OpenJPA back-end, though the given descriptions are tailored to OpenJPA's default JDBC store.

A few of the properties recognized by OpenJPA have been standardized in JPA 2.0 specification using equivalent names. These properties can be specified either by the JPA standard key or equivalent OpenJPA key. Specifying the same key once as JPA standard key and again as equivalent OpenJPA key in the same configuration, however, is not allowed. The following table lists these standard JPA properties and their OpenJPA equivalent.

*Table 2.1. Standard JPA Properties and OpenJPA equivalents*

Standard JPA 2.0	OpenJPA Equivalent
javax.persistence.jdbc.driver	openjpa.ConnectionDriverName
javax.persistence.jdbc.url	openjpa.ConnectionURL
javax.persistence.jdbc.user	openjpa.ConnectionUserName
javax.persistence.jdbc.password	openjpa.ConnectionPassword

### 2.5.1. openjpa.AutoClear

**Property name:** `openjpa.AutoClear`

**Configuration API:** `org.apache.openjpa.conf.OpenJPAConfiguration.getAutoClear`

**Resource adaptor config-property:** `AutoClear`

**Default:** `datastore`

**Possible values:** `datastore, all`

**Description:** When to automatically clear instance state: on entering a datastore transaction, or on entering any transaction.

### 2.5.2. openjpa.AutoDetach

**Property name:** `openjpa.AutoDetach`

**Configuration API:** `org.apache.openjpa.conf.OpenJPAConfiguration.getAutoDetach`

**Resource adaptor config-property:** `AutoDetach`

**Default:** `- null`

**Possible values:** `close, commit, nontx-read, rollback, none`

**Description:** A comma-separated list of events when managed instances will be automatically detached. When using the OpenJPA EntityManager this defaults to `close`, and `rollback` per the JPA spec. If you need to change this setting, you need to set it directly on an instantiated EntityManager.

none option is exclusive. It can not be specified with any other option. none option implies that managed objects will not be detached from the persistence context, the second-class object fields such as collections or date will *not* be proxied unlike normal circumstances. This option is relevant for specific use cases where the user application would not refer to the managed objects after the transaction and/or the context ends e.g. typical batch insertion scenario.

### 2.5.3. openjpa.BrokerFactory

---

**Property name:** `openjpa.BrokerFactory`

**Configuration API:** `org.apache.openjpa.conf.OpenJPAConfiguration.getBrokerFactory`

**Resource adaptor config-property:** `BrokerFactory`

**Default:** `jdbc`

**Possible values:** `jdbc, abstractstore, remote`

**Description:** A plugin string (see Section 2.4, “Plugin Configuration” [210]) describing the `org.apache.openjpa.kernel.BrokerFactory` type to use.

### 2.5.4. openjpa.BrokerImpl

---

**Property name:** `openjpa.BrokerImpl`

**Configuration API:** `org.apache.openjpa.conf.OpenJPAConfiguration.getBrokerImpl`

**Resource adaptor config-property:** `BrokerImpl`

**Default:** `default`

**Description:** A plugin string (see Section 2.4, “Plugin Configuration” [210]) describing the `org.apache.openjpa.kernel.Broker` type to use at runtime. See Section 9.1.2, “Broker Customization and Eviction” [335] on for details.

### 2.5.5. openjpa.Callbacks

---

**Property name:** `openjpa.Callbacks`

**Configuration API:** `org.apache.openjpa.conf.OpenJPAConfiguration.getCallbackOptionsInstance`

**Resource adaptor config-property:** `Callbacks`

**Default:** `default`

**Description:** A plugin string (see Section 2.4, “Plugin Configuration” [210]) to fine tune some of the configurable properties related to callbacks. The plug-in supports two boolean properties:

- `PostPersistCallbackImmediate`: whether the post-persist callback is invoked as soon as a new instance is managed. The default is `false`, implies that the post-persist callback is invoked after the instance been committed or flushed to the datastore.
- `AllowsMultipleMethodsForSameCallback`: whether multiple methods of the same class can handle the same callback event. Defaults to `false`.

### 2.5.6. openjpa.ClassResolver

---



**Property name:** `openjpa.ClassResolver`

**Configuration API:** `org.apache.openjpa.conf.OpenJPAConfiguration.getClassResolver`

**Resource adaptor config-property:** `ClassResolver`

**Default:** `default`

**Description:** A plugin string (see [Section 2.4, “Plugin Configuration” \[210\]](#)) describing the `org.apache.openjpa.util.ClassResolver` implementation to use for class name resolution. You may wish to plug in your own resolver if you have special classloading needs.

---

## 2.5.7. openjpa.Compatibility

**Property name:** `openjpa.Compatibility`

**Configuration API:** `org.apache.openjpa.conf.OpenJPAConfiguration.getCompatibility`

**Resource adaptor config-property:** `Compatibility`

**Default:** -

**Description:** Encapsulates options to mimic the behavior of previous OpenJPA releases.

---

## 2.5.8. openjpa.ConnectionDriverName

**Property name:** `openjpa.ConnectionDriverName`

**Configuration API:** `org.apache.openjpa.conf.OpenJPAConfiguration.getConnectionDriverName`

**Resource adaptor config-property:** `ConnectionDriverName`

**Default:** -

**Description:** The full class name of either the JDBC `java.sql.Driver`, or a `javax.sql.DataSource` implementation to use to connect to the database. See [Chapter 4, JDBC \[243\]](#) for details.

---

## 2.5.9. openjpa.Connection2DriverName

**Property name:** `openjpa.Connection2DriverName`

**Configuration API:** `org.apache.openjpa.conf.OpenJPAConfiguration.getConnection2DriverName`

**Resource adaptor config-property:** `Connection2DriverName`

**Default:** -

**Description:** This property is equivalent to the `openjpa.ConnectionDriverName` property described in [Section 2.5.8, “openjpa.ConnectionDriverName” \[213\]](#), but applies to the alternate connection factory used for unmanaged connections. See [Section 4.2.1, “Managed and XA DataSources” \[245\]](#) for details.

---

## 2.5.10. openjpa.ConnectionFactory

**Property name:** `openjpa.ConnectionFactory`

---

**Configuration API:** `org.apache.openjpa.conf.OpenJPAConfiguration.getConnectionFactory`

**Resource adaptor config-property:** `ConnectionFactory`

**Default:** -

**Description:** A `javax.sql.DataSource` to use to connect to the database. See [Chapter 4, JDBC \[243\]](#) for details.

---

## 2.5.11. openjpa.ConnectionFactory2

**Property name:** `openjpa.ConnectionFactory2`

**Configuration API:** `org.apache.openjpa.conf.OpenJPAConfiguration.getConnectionFactory2`

**Resource adaptor config-property:** `ConnectionFactory2`

**Default:** -

**Description:** An unmanaged `javax.sql.DataSource` to use to connect to the database. See [Chapter 4, JDBC \[243\]](#) for details.

---

## 2.5.12. openjpa.ConnectionFactoryName

**Property name:** `openjpa.ConnectionFactoryName`

**Configuration API:** `org.apache.openjpa.conf.OpenJPAConfiguration.getConnectionFactoryName`

**Resource adaptor config-property:** `ConnectionFactoryName`

**Default:** -

**Description:** The JNDI location of a `javax.sql.DataSource` to use to connect to the database. See [Chapter 4, JDBC \[243\]](#) for details.

---

## 2.5.13. openjpa.ConnectionFactory2Name

**Property name:** `openjpa.ConnectionFactory2Name`

**Configuration API:** `org.apache.openjpa.conf.OpenJPAConfiguration.getConnectionFactory2Name`

**Resource adaptor config-property:** `ConnectionFactory2Name`

**Default:** -

**Description:** The JNDI location of an unmanaged `javax.sql.DataSource` to use to connect to the database. See [Section 8.3, “XA Transactions” \[334\]](#) for details.

---

## 2.5.14. openjpa.ConnectionFactoryMode

**Property name:** `openjpa.ConnectionFactoryMode`

**Configuration API:** `org.apache.openjpa.conf.OpenJPAConfiguration.getConnectionFactoryMode`

**Resource adaptor config-property:** `ConnectionFactoryMode`

**Default:** `local`

**Possible values:** local, managed

**Description:** The connection factory mode to use when integrating with the application server's managed transactions. See [Section 4.2.1, “Managed and XA DataSources” \[245\]](#) for details.

---

## 2.5.15. openjpa.ConnectionFactoryProperties

---

**Property name:** `openjpa.ConnectionFactoryProperties`

**Configuration API:**

`org.apache.openjpa.conf.OpenJPAConfiguration.getConnectionFactoryProperties`

**Resource adaptor config-property:** `ConnectionFactoryProperties`

**Default:** -

**Description:** A plugin string (see [Section 2.4, “Plugin Configuration” \[210\]](#)) listing properties for configuration of the datasource in use. See the [Chapter 4, \*JDBC\* \[243\]](#) for details.

---

## 2.5.16. openjpa.ConnectionFactory2Properties

---

**Property name:** `openjpa.ConnectionFactory2Properties`

**Configuration API:**

`org.apache.openjpa.conf.OpenJPAConfiguration.getConnectionFactory2Properties`

**Resource adaptor config-property:** `ConnectionFactory2Properties`

**Default:** -

**Description:** This property is equivalent to the `openjpa.ConnectionFactoryProperties` property described in [Section 2.5.15, “openjpa.ConnectionFactoryProperties” \[215\]](#), but applies to the alternate connection factory used for unmanaged connections. See [Section 4.2.1, “Managed and XA DataSources” \[245\]](#) for details.

---

## 2.5.17. openjpa.ConnectionPassword

---

**Property name:** `openjpa.ConnectionPassword`

**Configuration API:** `org.apache.openjpa.conf.OpenJPAConfiguration.getConnectionPassword`

**Resource adaptor config-property:** `ConnectionPassword`

**Default:** -

**Description:** The password for the user specified in the `ConnectionUserName` property. See [Chapter 4, \*JDBC\* \[243\]](#) for details.

---

## 2.5.18. openjpa.Connection2Password

---

**Property name:** `openjpa.Connection2Password`

**Configuration API:** `org.apache.openjpa.conf.OpenJPAConfiguration.getConnection2Password`

**Resource adaptor config-property:** `Connection2Password`

**Default:** -

**Description:** This property is equivalent to the `openjpa.ConnectionPassword` property described in [Section 2.5.17](#), “`openjpa.ConnectionPassword`” [215], but applies to the alternate connection factory used for unmanaged connections. See [Section 4.2.1](#), “`Managed and XA DataSources`” [245] for details.

## 2.5.19. `openjpa.ConnectionProperties`

---

**Property name:** `openjpa.ConnectionProperties`

**Configuration API:** `org.apache.openjpa.conf.OpenJPAConfiguration.getConnectionProperties`

**Resource adaptor config-property:** `ConnectionProperties`

**Default:** -

**Description:** A plugin string (see [Section 2.4](#), “`Plugin Configuration`” [210]) listing properties to configure the driver listed in the `ConnectionDriverName` property described below. See [Chapter 4](#), *JDBC* [243] for details.

## 2.5.20. `openjpa.Connection2Properties`

---

**Property name:** `openjpa.Connection2Properties`

**Configuration API:** `org.apache.openjpa.conf.OpenJPAConfiguration.getConnection2Properties`

**Resource adaptor config-property:** `Connection2Properties`

**Default:** -

**Description:** This property is equivalent to the `openjpa.ConnectionProperties` property described in [Section 2.5.19](#), “`openjpa.ConnectionProperties`” [216], but applies to the alternate connection factory used for unmanaged connections. See [Section 4.2.1](#), “`Managed and XA DataSources`” [245] for details.

## 2.5.21. `openjpa.ConnectionURL`

---

**Property name:** `openjpa.ConnectionURL`

**Configuration API:** `org.apache.openjpa.conf.OpenJPAConfiguration.getConnectionURL`

**Resource adaptor config-property:** `ConnectionURL`

**Default:** -

**Description:** The JDBC URL for the database. See [Chapter 4](#), *JDBC* [243] for details.

## 2.5.22. `openjpa.Connection2URL`

---

**Property name:** `openjpa.Connection2URL`

**Configuration API:** `org.apache.openjpa.conf.OpenJPAConfiguration.getConnection2URL`

**Resource adaptor config-property:** `Connection2URL`

**Default:** -

**Description:** This property is equivalent to the `openjpa.ConnectionURL` property described in [Section 2.5.21](#), “`openjpa.ConnectionURL`” [216], but applies to the alternate connection factory used for unmanaged connections. See [Section 4.2.1](#), “`Managed and XA DataSources`” [245] for details.

---

## 2.5.23. openjpa.ConnectionUserName

---

**Property name:** `openjpa.ConnectionUserName`

**Configuration API:** `org.apache.openjpa.conf.OpenJPAConfiguration.getConnectionUserName`

**Resource adaptor config-property:** `ConnectionUserName`

**Default:** -

**Description:** The user name to use when connecting to the database. See the [Chapter 4, JDBC](#) [243] for details.

---

## 2.5.24. openjpa.Connection2UserName

---

**Property name:** `openjpa.Connection2UserName`

**Configuration API:** `org.apache.openjpa.conf.OpenJPAConfiguration.getConnection2UserName`

**Resource adaptor config-property:** `Connection2UserName`

**Default:** -

**Description:** This property is equivalent to the `openjpa.ConnectionUserName` property described in [Section 2.5.23, “openjpa.ConnectionUserName”](#) [217], but applies to the alternate connection factory used for unmanaged connections. See [Section 4.2.1, “Managed and XA DataSources”](#) [245] for details.

---

## 2.5.25. openjpa.ConnectionRetainMode

---

**Property name:** `openjpa.ConnectionRetainMode`

**Configuration API:** `org.apache.openjpa.conf.OpenJPAConfiguration.getConnectionRetainMode`

**Resource adaptor config-property:** `ConnectionRetainMode`

**Default:** `on-demand`

**Description:** Controls how OpenJPA uses datastore connections. This property can also be specified for individual sessions. See [Section 4.8, “Configuring the Use of JDBC Connections”](#) [262] for details.

---

## 2.5.26. openjpa.DataCache

---

**Property name:** `openjpa.DataCache`

**Configuration API:** `org.apache.openjpa.conf.OpenJPAConfiguration.getDataCache`

**Resource adaptor config-property:** `DataCache`

**Default:** `false`

**Description:** A plugin list string (see [Section 2.4, “Plugin Configuration”](#) [210]) describing the `org.apache.openjpa.datacache.DataCaches` to use for data caching. See [Section 10.1.1, “Data Cache Configuration”](#) [348] for details.

---

## 2.5.27. openjpa.DataCacheManager

---

**Property name:** `openjpa.DataCacheManager`

**Configuration API:** `org.apache.openjpa.conf.OpenJPAConfiguration.getDataCacheManager`

**Resource adaptor config-property:** `DataCacheManager`

**Default:** `default`

**Description:** A plugin string (see [Section 2.4, “Plugin Configuration” \[210\]](#)) describing the `openjpa.datacache.DataCacheManager` that manages the system data caches. See [Section 10.1, “Data Cache” \[348\]](#) for details on data caching.

---

## 2.5.28. `openjpa.DataCacheMode`

**Property name:** `openjpa.DataCacheMode`

**Configuration API:** `org.apache.openjpa.conf.OpenJPAConfiguration.getDataCacheMode`

**Resource adaptor config-property:** `DataCacheMode`

**Default:** `DataCacheMode.UNSPECIFIED` (see javadoc for details)

**Description:** Determines which entities will be included in the DataCache. May be any of the values defined in [../javadoc/org/apache/openjpa/datacache/DataCacheMode.html](#).

---

## 2.5.29. `openjpa.DataCacheTimeout`

**Property name:** `openjpa.DataCacheTimeout`

**Configuration API:** `org.apache.openjpa.conf.OpenJPAConfiguration.getDataCacheTimeout`

**Resource adaptor config-property:** `DataCacheTimeout`

**Default:** `-1`

**Description:** The number of milliseconds that data in the data cache is valid. Set this to -1 to indicate that data should not expire from the cache. This property can also be specified for individual classes. See [Section 10.1.1, “Data Cache Configuration” \[348\]](#) for details.

---

## 2.5.30. `openjpa.DetachState`

**Property name:** `openjpa.DetachState`

**Configuration API:** `org.apache.openjpa.conf.OpenJPAConfigurationImpl.getDetachState`

**Resource adaptor config-property:** `DetachState`

**Default:** `loaded`

**Possible values:** `loaded, fetch-groups, all`

**Description:** Determines which fields are part of the detached graph and related options. For more details, see [Section 12.1.3, “Defining the Detached Object Graph” \[365\]](#).

---

## 2.5.31. `openjpa.DynamicDataStructs`

---

**Property name:** `openjpa.DynamicDataStructs`

**Configuration API:** `org.apache.openjpa.conf.OpenJPAConfiguration.getDynamicDataStructs`

**Resource adaptor config-property:** `DynamicDataStructs`

**Default:** `false`

**Description:** Whether to dynamically generate customized structs to hold persistent data. Both the OpenJPA data cache and the remote framework rely on data structs to cache and transfer persistent state. With dynamic structs, OpenJPA can customize data storage for each class, eliminating the need to generate primitive wrapper objects. This saves memory and speeds up certain runtime operations. The price is a longer warm-up time for the application - generating and loading custom classes into the JVM takes time. Therefore, only set this property to `true` if you have a long-running application where the initial cost of class generation is offset by memory and speed optimization over time.

---

## 2.5.32. `openjpa.DynamicEnhancementAgent`

**Property name:** `openjpa.DynamicEnhancementAgent`

**Configuration API:** `org.apache.openjpa.conf.OpenJPAConfiguration.getDynamicEnhancementAgent`

**Resource adaptor config property:** `DynamicEnhancementAgent`

**Default:** `true`

**Description:** The `DynamicEnhancementAgent` property controls whether or not OpenJPA will attempt to dynamically load the `PCEnhancer.javaagent`.

See the reference guide for more information [Section 5.2.4, “Enhancing Dynamically at Runtime” \[276\]](#)

---

## 2.5.33. `openjpa.FetchBatchSize`

**Property name:** `openjpa.FetchBatchSize`

**Configuration API:** `org.apache.openjpa.conf.OpenJPAConfiguration.getFetchBatchSize`

**Resource adaptor config-property:** `FetchBatchSize`

**Default:** `-1`

**Description:** The number of rows to fetch at once when scrolling through a result set. The fetch size can also be set at runtime. See [Section 4.10, “Large Result Sets” \[265\]](#) for details.

---

## 2.5.34. `openjpa.EncryptionProvider`

**Property name:** `openjpa.EncryptionProvider`

**Configuration API:** `org.apache.openjpa.conf.OpenJPAConfiguration.getEncryptionProvider`

**Resource adaptor config-property:** `EncryptionProvider`

**Default:** `false`

**Description:** A plugin list string (see [Section 2.4, “Plugin Configuration” \[210\]](#)) describing the `org.apache.openjpa.lib.encrypted.EncryptionProviders` to use for connection password encryption. See [Chapter 11, \*Encryption Provider\* \[363\]](#) for details.

## 2.5.35. openjpa.FetchGroups

---

**Property name:** `openjpa.FetchGroups`

**Configuration API:** `org.apache.openjpa.conf.OpenJPAConfiguration.getFetchGroups`

**Resource adaptor config-property:** `FetchGroups`

**Default:** -

**Description:** A comma-separated list of fetch group names that are to be loaded when retrieving objects from the datastore. Fetch groups can also be set at runtime. See [Section 5.7, “Fetch Groups” \[290\]](#) for details.

## 2.5.36. openjpa.FlushBeforeQueries

---

**Property name:** `openjpa.FlushBeforeQueries`

**Property name:** `openjpa.FlushBeforeQueries`

**Configuration API:** `org.apache.openjpa.conf.OpenJPAConfiguration.getFlushBeforeQueries`

**Resource adaptor config-property:** `FlushBeforeQueries`

**Default:** `true`

**Description:** Whether or not to flush any changes made in the current transaction to the datastore before executing a query. See [Section 4.8, “Configuring the Use of JDBC Connections” \[262\]](#) for details.

## 2.5.37. openjpa.IgnoreChanges

---

**Property name:** `openjpa.IgnoreChanges`

**Configuration API:** `org.apache.openjpa.conf.OpenJPAConfiguration.getIgnoreChanges`

**Resource adaptor config-property:** `IgnoreChanges`

**Default:** `false`

**Description:** Whether to consider modifications to persistent objects made in the current transaction when evaluating queries. Setting this to `true` allows OpenJPA to ignore changes and execute the query directly against the datastore. A value of `false` forces OpenJPA to consider whether the changes in the current transaction affect the query, and if so to either evaluate the query in-memory or flush before running it against the datastore.

## 2.5.38. openjpa.Id

---

**Property name:** `openjpa.Id`

**Resource adaptor config-property:** `Id`

**Default:** `none`

**Description:** An environment-specific identifier for this configuration. This might correspond to a JPA persistence-unit name, or to some other more-unique value available in the current environment.

## 2.5.39. openjpa.InitializeEagerly

---



**Property name:** `openjpa.InitializeEagerly`

**Configuration API:** `org.apache.openjpa.conf.OpenJPAConfiguration.isInitializeEagerly`

**Resource adaptor config-property:** `InitializeEagerly`

**Default:** `false`

**Possible values:** `false, true`

**Description:** Controls whether initialization is eager or lazy. Eager initialization imply all persistent classes, their mapping information, database connectivity and all other resources specified in the configuration of a persistence unit will be initialized when a persistent unit is constructed. The default behavior is lazy i.e. persistent classes, database and other resources are initialized only when the application refers to a resource for the first time.

## 2.5.40. openjpa.Instrumentation

---

**Property name:** `openjpa.Instrumentation`

**Configuration API:** `org.apache.openjpa.conf.OpenJPAConfiguration.getInstrumentation`

**Resource adaptor config-property:** `Instrumentation`

**Default:** `-`

**Possible values:** `jmx, custom plugin string`

**Description:** A plugin string (see Section 2.4, “Plugin Configuration” [210]) describing one or more instances of `org.apache.openjpa.lib.instrumentation.InstrumentationProvider` and specific instruments to enable. See Chapter 16, *Instrumentation* [388] for details.

## 2.5.41. openjpa.InverseManager

---

**Property name:** `openjpa.InverseManager`

**Configuration API:** `org.apache.openjpa.conf.OpenJPAConfiguration.getInverseManager`

**Resource adaptor config-property:** `InverseManager`

**Default:** `false`

**Possible values:** `false, true`

**Description:** A plugin string (see Section 2.4, “Plugin Configuration” [210]) describing a `org.apache.openjpa.kernel.InverseManager` to use for managing bidirectional relations upon a flush. See Section 5.5, “Managed Inverses” [282] for usage documentation.

## 2.5.42. openjpa.LockManager

---

**Property name:** `openjpa.LockManager`

**Configuration API:** `org.apache.openjpa.conf.OpenJPAConfiguration.getLockManager`

**Resource adaptor config-property:** `LockManager`

**Default:** mixed

**Possible values:** none, version, pessimistic, mixed

**Description:** A plugin string (see [Section 2.4, “Plugin Configuration” \[210\]](#)) describing a `org.apache.openjpa.kernel.LockManager` to use for acquiring locks on persistent instances during transactions. See [Section 9.3.4, “Lock Manager” \[340\]](#) for more information.

---

## 2.5.43. openjpa.LockTimeout

**Property name:** `openjpa.LockTimeout`

**Configuration API:** `org.apache.openjpa.conf.OpenJPAConfiguration.getLockTimeout`

**Resource adaptor config-property:** `LockTimeout`

**Default:** -1

**Description:** The number of milliseconds to wait for an object lock before throwing an exception, or -1 for no limit. See [Section 9.3, “Object Locking” \[338\]](#) for details.

---

## 2.5.44. openjpa.Log

**Property name:** `openjpa.Log`

**Configuration API:** `org.apache.openjpa.lib.conf.Configuration.getLog`

**Resource adaptor config-property:** `Log`

**Default:** true

**Possible values:** openjpa, commons, log4j, slf4j, none

**Description:** A plugin string (see [Section 2.4, “Plugin Configuration” \[210\]](#)) describing a `org.apache.openjpa.lib.log.LogFactory` to use for logging. For details on logging, see [Chapter 3, Logging and Auditing \[236\]](#).

---

## 2.5.45. openjpa.ManagedRuntime

**Property name:** `openjpa.ManagedRuntime`

**Configuration API:** `org.apache.openjpa.conf.OpenJPAConfiguration.getManagedRuntime`

**Resource adaptor config-property:** `ManagedRuntime`

**Default:** auto

**Description:** A plugin string (see [Section 2.4, “Plugin Configuration” \[210\]](#)) describing the `org.apache.openjpa.ee.ManagedRuntime` implementation to use for obtaining a reference to the `TransactionManager` in an enterprise environment.

---

## 2.5.46. openjpa.Mapping

**Property name:** `openjpa.Mapping`

**Configuration API:** `org.apache.openjpa.conf.OpenJPAConfiguration.getMapping`

**Resource adaptor config-property:** Mapping

**Default:** -

**Description:** The symbolic name of the object-to-datastore mapping to use.

---

## 2.5.47. openjpa.MaxFetchDepth

---

**Property name:** `openjpa.MaxFetchDepth`

**Configuration API:** `org.apache.openjpa.conf.OpenJPAConfiguration.getMaxFetchDepth`

**Resource adaptor config-property:** MaxFetchDepth

**Default:** -1

**Description:** The maximum depth of relations to traverse when eager fetching. Use -1 for no limit. Defaults to no limit. See Section 5.8, “Eager Fetching” [294] for details on eager fetching.

---

## 2.5.48. openjpa.MetaDataFactory

---

**Property name:** `openjpa.MetaDataFactory`

**Configuration API:** `org.apache.openjpa.conf.OpenJPAConfiguration.getMetaDataFactory`

**Resource adaptor config-property:** MetaDataFactory

**Default:** jpa

**Description:** A plugin string (see Section 2.4, “Plugin Configuration” [210]) describing the `openjpa.meta.MetaDataFactory` to use to store and retrieve metadata for your persistent classes. See Section 6.1, “Metadata Factory” [297] for details.

---

## 2.5.49. openjpa.MetaDataRepository

---

**Property name:** `openjpa.MetaDataRepository`

**Configuration API:** `org.apache.openjpa.conf.OpenJPAConfiguration.getMetaDataRepository`

**Resource adaptor config-property:** MetaDataRepository

**Default:** none

**Description:** A plugin string (see Section 2.4, “Plugin Configuration” [210]) describing the `openjpa.meta.MetaDataRepository` to use to store and retrieve metadata for your persistent classes. See Section 6.2, “Metadata Repository” [297] for details.

---

## 2.5.50. openjpa.Multithreaded

---

**Property name:** `openjpa.Multithreaded`

**Configuration API:** `org.apache.openjpa.conf.OpenJPAConfiguration.getMultithreaded`

**Resource adaptor config-property:** Multithreaded

**Default:** false

**Description:** Whether persistent instances and OpenJPA components other than the `EntityManagerFactory` will be accessed by multiple threads at once.

## 2.5.51. `openjpa.Optimistic`

---

**Property name:** `openjpa.Optimistic`

**Configuration API:** `org.apache.openjpa.conf.OpenJPAConfiguration.getOptimistic`

**Resource adaptor config-property:** `Optimistic`

**Default:** `true`

**Description:** Selects between optimistic and pessimistic (datastore) transactional modes.

## 2.5.52. `openjpa.OptimizeIdCopy`

---

**Property name:** `openjpa.OptimizeIdCopy`

**Configuration API:** `org.apache.openjpa.conf.OpenJPAConfiguration.getOptimizeIdCopy`

**Resource adaptor config-property:** `OptimizeIdCopy`

**Default:** `false`

**Description:** Attempt to optimize id class copy operations used internally by the provider during various ORM operations. This optimization is only applicable for entities using simple id classes (via `@IdClass` or XML equivalent) that do not have public setters, provide a public constructor with exact matching parameter types, and perform direct assignments to id class fields within the constructor. If these conditions are met, OpenJPA will use a public constructor during internal id copy operations instead of less optimal reflection. Optimization of id copy occurs during the enhancement phase. If the enhancer determines optimization cannot occur, it will fallback to the normal behavior. A side effect of enabling this property is that an id class constructor will be called by the provider during runtime operations. If there is logic in the constructor in addition to field initialization, (parameter verification, for example) that logic will also be executed during the operation, which could result in a change in runtime behavior.

## 2.5.53. `openjpa.OrphanedKeyAction`

---

**Property name:** `openjpa.OrphanedKeyAction`

**Configuration API:** `org.apache.openjpa.conf.OpenJPAConfiguration.getOrphanedKeyAction`

**Resource adaptor config-property:** `OrphanedKeyAction`

**Default:** `log`

**Possible values:** `log, exception, none`

**Description:** A plugin string (see [Section 2.4, “Plugin Configuration” \[210\]](#)) describing a `org.apache.openjpa.event.OrphanedKeyAction` to invoke when OpenJPA discovers an orphaned datastore key. See [Section 7.11, “Orphaned Keys” \[331\]](#) for details.

## 2.5.54. `openjpa.NontransactionalRead`

---

**Property name:** `openjpa.NontransactionalRead`

**Configuration API:** `org.apache.openjpa.conf.OpenJPAConfiguration.getNontransactionalRead`

**Resource adaptor config-property:** `NontransactionalRead`

**Default:** `true`

**Description:** Whether the OpenJPA runtime will allow you to read data outside of a transaction.

---

## 2.5.55. openjpa.NontransactionalWrite

---

**Property name:** `openjpa.NontransactionalWrite`

**Configuration API:** `org.apache.openjpa.conf.OpenJPAConfiguration.getNontransactionalWrite`

**Resource adaptor config-property:** `NontransactionalWrite`

**Default:** `true`

**Description:** Whether you can modify persistent objects and perform persistence operations outside of a transaction. Changes will take effect on the next transaction.

---

## 2.5.56. openjpa.ProxyManager

---

**Property name:** `openjpa.ProxyManager`

**Configuration API:** `org.apache.openjpa.conf.OpenJPAConfiguration.getProxyManager`

**Resource adaptor config-property:** `ProxyManager`

**Default:** `default`

**Description:** A plugin string (see [Section 2.4, “Plugin Configuration” \[210\]](#)) describing a `org.apache.openjpa.util.ProxyManager` to use for proxying mutable second class objects. See [Section 5.6.4.3, “Custom Proxies” \[286\]](#) for details.

---

## 2.5.57. openjpa.PostLoadOnMerge

---

**Property name:** `openjpa.PostLoadOnMerge`

**Configuration API:** `org.apache.openjpa.conf.OpenJPAConfiguration.getPostLoadOnMerge`

**Resource adaptor config-property:** `PostLoadOnMerge`

**Default:** `false`

**Description:** Whether the OpenJPA runtime will trigger a PostLoad lifecycle event for `EntityManager#merge()`. If you enable this option, OpenJPA will also ensure that the whole entity from the database will get passed to the PostLoad entity listener.

---

## 2.5.58. openjpa.QueryCache

---

**Property name:** `openjpa.QueryCache`

**Configuration API:** `org.apache.openjpa.conf.OpenJPAConfiguration.getQueryCache`

**Resource adaptor config-property:** `QueryCache`

**Default:** false

**Description:** A plugin string (see Section 2.4, “Plugin Configuration” [210]) describing the `org.apache.openjpa.datacache.QueryCache` implementation to use for caching of queries loaded from the data store. See Section 10.1.4, “Query Cache” [355] for details.

---

## 2.5.59. openjpa.QueryCompilationCache

---

**Property name:** `openjpa.QueryCompilationCache`

**Resource adaptor config-property:** `QueryCompilationCache`

**Default:** true.

**Description:** A plugin string (see Section 2.4, “Plugin Configuration” [210]) describing the `java.util.Map` to use for caching of data used during query compilation. See Section 10.2, “Query Compilation Cache” [359] for details.

---

## 2.5.60. openjpa.ReadLockLevel

---

**Property name:** `openjpa.ReadLockLevel`

**Configuration API:** `org.apache.openjpa.conf.OpenJPAConfiguration.getReadLockLevel`

**Resource adaptor config-property:** `ReadLockLevel`

**Default:** read

**Possible values:** none, read, write, optimistic, optimistic-force-increment, pessimistic-read, pessimistic-write, pessimistic-force-increment, numeric values for lock-manager specific lock levels

**Description:** The default level at which to lock objects retrieved during a non-optimistic transaction. Note that for the default JDBC lock manager, read and write lock levels are equivalent. Lock levels `pessimistic-read`, `pessimistic-write` and `pessimistic-force-increment` are in effect only when the mixed lock manager is used.

---

## 2.5.61. openjpa.RemoteCommitProvider

---

**Property name:** `openjpa.RemoteCommitProvider`

**Configuration API:** `org.apache.openjpa.conf.OpenJPAConfiguration.getRemoteCommitProvider`

**Resource adaptor config-property:** `RemoteCommitProvider`

**Default:** - If `openjpa.DataCache` is enabled, the default value is `sjvm`.

**Description:** A plugin string (see Section 2.4, “Plugin Configuration” [210]) describing the `org.apache.openjpa.event.RemoteCommitProvider` implementation to use for distributed event notification. See Section 12.2.1, “Remote Commit Provider Configuration” [367] for more information.

---

## 2.5.62. openjpa.RestoreState

---

**Property name:** `openjpa.RestoreState`

**Configuration API:** `org.apache.openjpa.conf.OpenJPAConfiguration.getRestoreState`

**Resource adaptor config-property:** `RestoreState`

**Default:** none

**Possible values:** none, immutable, all

**Description:** Whether to restore managed fields to their pre-transaction values when a rollback occurs.

---

## 2.5.63. openjpa.RetainState

---

**Property name:** `openjpa.RetainState`

**Configuration API:** `org.apache.openjpa.conf.OpenJPAConfiguration.getRetainState`

**Resource adaptor config-property:** `RetainState`

**Default:** true

**Description:** Whether persistent fields retain their values on transaction commit.

---

## 2.5.64. openjpa.RetryClassRegistration

---

**Property name:** `openjpa.RetryClassRegistration`

**Configuration API:** `org.apache.openjpa.conf.OpenJPAConfiguration.getRetryClassRegistration`

**Resource adaptor config-property:** `RetryClassRegistration`

**Default:** false

**Description:** Controls whether to log a warning and defer registration instead of throwing an exception when a persistent class cannot be fully processed. This property should *only* be used in complex classloader situations where security is preventing OpenJPA from reading registered classes. Setting this to true unnecessarily may obscure more serious problems.

---

## 2.5.65. openjpa.RuntimeUnenhancedClasses

---

**Property name:** `openjpa.RuntimeUnenhancedClasses`

**Configuration API:** `org.apache.openjpa.conf.OpenJPAConfiguration.getRuntimeUnenhancedClasses`

**Resource adaptor config property:** `RuntimeUnenhancedClasses`

**Default:** unsupported

**Possible values:** supported, unsupported, warn

**Description:** The `RuntimeUnenhancedClasses` property controls how OpenJPA handles classes that have not been enhanced by the PCEnhancer tool or automatically by a javaagent. If `RuntimeUnenhancedClasses` is set to `supported` OpenJPA will automatically create subclasses for unenhanced entity classes. If set to `unsupported` OpenJPA will not create subclasses for unenhanced entity classes and will throw an exception when they are detected. If set to `warn` OpenJPA will not create subclasses for unenhanced entity classes but will log a warning message.

This function is often useful for rapid prototyping but is not *generally* recommended for use in production. Please consult the reference guide before changing the default value.

See the reference guide section on unenhanced types for more information [Section 5.2.5, “Omitting the OpenJPA enhancer”](#) [277]

---

## 2.5.66. openjpa.SavepointManager

---

**Property name:** `openjpa.SavepointManager`

**Configuration API:** `org.apache.openjpa.conf.OpenJPAConfiguration.getSavepointManager`

**Resource adaptor config-property:** `SavepointManager`

**Default:** `in-mem`

**Possible values:** `in-mem, jdbc`

**Description:** A plugin string (see Section 2.4, “Plugin Configuration” [210]) describing a `org.apache.openjpa.kernel.SavepointManager` to use for managing transaction savepoints. See Section 9.4, “Savepoints” [342] for details.

---

## 2.5.67. openjpa.Sequence

---

**Property name:** `openjpa.Sequence`

**Configuration API:** `org.apache.openjpa.conf.OpenJPAConfiguration.getSequence`

**Resource adaptor config-property:** `Sequence`

**Default:** `table`

**Description:** A plugin string (see Section 2.4, “Plugin Configuration” [210]) describing the `org.apache.openjpa.kernel.Seq` implementation to use for the system sequence. See Section 9.6, “Generators” [344] for more information.

---

## 2.5.68. openjpa.Specification

---

**Property name:** `openjpa.Specification`

**Configuration API:** `org.apache.openjpa.conf.OpenJPAConfiguration.getSpecificationInstance`

**Resource adaptor config-property:** `Specification`

**Default:** `table`

**Description:** A formatted string describing the Specification to use for the default configuration options. The format of the Specification string is `name [major.[minor]]` where `name` denotes the name of the Specification such as `JPA` or `JDO`, `major` denotes the major integral version number of the Specification and `minor` denotes a minor version which can be an arbitrary string. See Section 2.6.20, “Compatibility with Specification” [234] for more information.

---

## 2.5.69. openjpa.TransactionMode

---

**Property name:** `openjpa.TransactionMode`

**Configuration API:** `org.apache.openjpa.conf.OpenJPAConfiguration.getTransactionMode`

**Resource adaptor config-property:** `TransactionMode`

**Default:** `local`

**Possible values:** `local, managed`



**Description:** The default transaction mode to use. You can override this setting per-session.

## 2.5.70. openjpa.UseTCCLinSelectNew

---

**Property name:** `openjpa.UseTCCLinSelectNew`

**Configuration API:** `org.apache.openjpa.conf.OpenJPAConfiguration.getUseTCCLinSelectNew`

**Resource adaptor config-property:** `UseTCCLinSelectNew`

**Default:** `false`

**Since:** `OpenJPA-2.4.2`

**Possible values:** `true, false`

**Description:** Whether to try to use the `ThreadContextClassLoader` as fallback if the given class in a `SELECT NEW` statement could not be found with the default `ClassLoader`. This is mostly useful in EAR and OSGi environments. By default the `ClassLoader` of the entity is used.

## 2.5.71. openjpa.WriteLockLevel

---

**Property name:** `openjpa.WriteLockLevel`

**Configuration API:** `org.apache.openjpa.conf.OpenJPAConfiguration.getWriteLockLevel`

**Resource adaptor config-property:** `WriteLockLevel`

**Default:** `write`

**Possible values:** `none, read, write, optimistic, optimistic-force-increment, pessimistic-read, pessimistic-write, pessimistic-force-increment, numeric values for lock-manager specific lock levels.`

**Description:** The default level at which to lock objects changed during a non-optimistic transaction. Note that for the default JDBC lock manager, `read` and `write` lock levels are equivalent. Lock levels `pessimistic-read`, `pessimistic-write` and `pessimistic-force-increment` are in effect only when the mixed lock manager is used.

## 2.6. OpenJPA JDBC Properties

---

The following properties apply exclusively to the OpenJPA JDBC back-end.

### 2.6.1. openjpa.jdbc.ConnectionDecorators

---

**Property name:** `openjpa.jdbc.ConnectionDecorators`

**Configuration API:** `org.apache.openjpa.jdbc.conf.JDBCConfiguration.getConnectionDecorators`

**Resource adaptor config-property:** `ConnectionDecorators`

**Default:** `-`

**Description:** A comma-separated list of plugin strings (see [Section 2.4, “Plugin Configuration” \[210\]](#)) describing `org.apache.openjpa.lib.jdbc.ConnectionDecorator` instances to install on the connection factory. These decorators can wrap connections passed from the underlying `DataSource` to add functionality. OpenJPA will pass all

connections through the list of decorators before using them. Note that by default OpenJPA employs all of the built-in decorators in the `org.apache.openjpa.lib.jdbc` package already; you do not need to list them here.

## 2.6.2. openjpa.jdbc.DBDictionary

---

**Property name:** `openjpa.jdbc.DBDictionary`

**Configuration API:** `org.apache.openjpa.jdbc.conf.JDBCConfiguration.getDBDictionary`

**Resource adaptor config-property:** `DBDictionary`

**Default:** Based on the `openjpa.ConnectionURL` `openjpa.ConnectionDriverName`

**Description:** A plugin string (see Section 2.4, “Plugin Configuration” [210]) describing the `org.apache.openjpa.jdbc.sql.DBDictionary` to use for database interaction. OpenJPA typically auto-configures the dictionary based on the JDBC URL, but you may have to set this property explicitly if you are using an unrecognized driver, to plug in your own dictionary for a database OpenJPA does not support out-of-the-box, or if you like to change the default configuration of an existing dictionary. See Section 4.4, “Database Support” [247] for details.

## 2.6.3. openjpa.jdbc.DriverDataSource

---

**Property name:** `openjpa.jdbc.DriverDataSource`

**Configuration API:** `org.apache.openjpa.jdbc.conf.JDBCConfiguration.getDriverDataSource`

**Resource adaptor config-property:** `DriverDataSource`

**Default:** `auto`

**Possible values:** `auto`, `dbcp`, `simple`

**Description:** The alias or full class name of the `org.apache.openjpa.jdbc.schema.DriverDataSource` implementation to use to wrap JDBC Driver classes with `javax.sql.DataSource` instances. The `org.apache.openjpa.jdbc.schema.AutoDriverDataSource` implementation is the default and will select either the `DBCPDriverDataSource` or `SimpleDriverDataSource` based on if Apache Commons DBCP is available on the classpath. The `org.apache.openjpa.jdbc.schema.DBCPDriverDataSource` implementation requires Apache Commons DBCP to be available on the classpath and uses `org.apache.commons.dbcp.BasicDataSource` to provide connection pooling.

## 2.6.4. openjpa.jdbc.EagerFetchMode

---

**Property name:** `openjpa.jdbc.EagerFetchMode`

**Configuration API:** `org.apache.openjpa.jdbc.conf.JDBCConfiguration.getEagerFetchMode`

**Resource adaptor config-property:** `EagerFetchMode`

**Default:** `parallel`

**Possible values:** `parallel`, `join`, `none`

**Description:** Optimizes how OpenJPA loads persistent relations. This setting can also be varied at runtime. See Section 5.8, “Eager Fetching” [294] for details.

## 2.6.5. openjpa.jdbc.FetchDirection

---

**Property name:** `openjpa.jdbc.FetchDirection`

**Configuration API:** `org.apache.openjpa.jdbc.conf.JDBCConfiguration.getFetchDirection`

**Resource adaptor config-property:** `FetchDirection`

**Default:** `forward`

**Possible values:** `forward, reverse, unknown`

**Description:** The expected order in which query result lists will be accessed. This property can also be varied at runtime. See [Section 4.10, “Large Result Sets” \[265\]](#) for details.

## 2.6.6. openjpa.jdbc.JDBCListeners

---

**Property name:** `openjpa.jdbc.JDBCListeners`

**Configuration API:** `org.apache.openjpa.jdbc.conf.JDBCConfiguration.getJDBCListeners`

**Resource adaptor config-property:** `JDBCListeners`

**Default:** `-`

**Description:** A comma-separated list of plugin strings (see [Section 2.4, “Plugin Configuration” \[210\]](#)) describing `org.apache.openjpa.lib.jdbc.JDBCListener` event listeners to install. These listeners will be notified on various JDBC-related events.

## 2.6.7. openjpa.jdbc.LRSSize

---

**Property name:** `openjpa.jdbc.LRSSize`

**Configuration API:** `org.apache.openjpa.jdbc.conf.JDBCConfiguration.getLRSSize`

**Resource adaptor config-property:** `LRSSize`

**Default:** `query`

**Possible values:** `query, last, unknown`

**Description:** The strategy to use to calculate the size of a result list. This property can also be varied at runtime. See [Section 4.10, “Large Result Sets” \[265\]](#) for details.

## 2.6.8. openjpa.jdbc.MappingDefaults

---

**Property name:** `openjpa.jdbc.MappingDefaults`

**Configuration API:** `org.apache.openjpa.jdbc.conf.JDBCConfiguration.getMappingDefaults`

**Resource adaptor config-property:** `MappingDefaults`

**Default:** `jpa`

**Description:** A plugin string (see [Section 2.4, “Plugin Configuration” \[210\]](#)) describing the `org.apache.openjpa.jdbc.meta.MappingDefaults` to use to define default column names, table names, and constraints for your persistent classes. See [Section 7.5, “Mapping Factory” \[313\]](#) for details.

---

## 2.6.9. openjpa.jdbc.MappingFactory

---

**Property name:** `openjpa.jdbc.MappingFactory`

**Configuration API:** `org.apache.openjpa.jdbc.conf.JDBCConfiguration.getMappingFactory`

**Resource adaptor config-property:** `MappingFactory`

**Default:** -

**Description:** A plugin string (see [Section 2.4, “Plugin Configuration” \[210\]](#)) describing the `org.apache.openjpa.meta.MetadataFactory` to use to store and retrieve object-relational mapping information for your persistent classes. See [Section 7.5, “Mapping Factory” \[313\]](#) for details.

---

## 2.6.10. openjpa.jdbc.QuerySQLCache

---

**Property name:** `openjpa.jdbc.QuerySQLCache`

**Resource adaptor config-property:** `QuerySQLCache`

**Default:** `true`.

**Description:** A plugin string (see [Section 2.4, “Plugin Configuration” \[210\]](#)) describing the options to cache and reuse SQL statements generated for JPQL queries. See [Section 10.3, “Prepared SQL Cache” \[360\]](#) for details.

---

## 2.6.11. openjpa.jdbc.ResultSetType

---

**Property name:** `openjpa.jdbc.ResultSetType`

**Configuration API:** `org.apache.openjpa.jdbc.conf.JDBCConfiguration.getResultSetType`

**Resource adaptor config-property:** `ResultSetType`

**Default:** `forward-only`

**Possible values:** `forward-only`, `scroll-sensitive`, `scroll-insensitive`

**Description:** The JDBC result set type to use when fetching result lists. This property can also be varied at runtime. See [Section 4.10, “Large Result Sets” \[265\]](#) for details.

---

## 2.6.12. openjpa.jdbc.Schema

---

**Property name:** `openjpa.jdbc.Schema`

**Configuration API:** `org.apache.openjpa.jdbc.conf.JDBCConfiguration.getSchema`

**Resource adaptor config-property:** `Schema`

**Default:** -

**Description:** The default schema name to prepend to unqualified table names. Also, the schema in which OpenJPA will create new tables. See [Section 4.11, “Default Schema” \[266\]](#) for details.

---

## 2.6.13. openjpa.jdbc.SchemaFactory

---

**Property name:** `openjpa.jdbc.SchemaFactory`

**Configuration API:** `org.apache.openjpa.jdbc.conf.JDBCConfiguration.getSchemaFactory`

**Resource adaptor config-property:** `SchemaFactory`

**Default:** `dynamic`

**Possible values:** `dynamic, native, file, table, others`

**Description:** A plugin string (see [Section 2.4, “Plugin Configuration” \[210\]](#)) describing the `org.apache.openjpa.jdbc.schema.SchemaFactory` to use to store and retrieve information about the database schema. See [Section 4.12.2, “Schema Factory” \[267\]](#) for details.

---

## 2.6.14. openjpa.jdbc.Schemas

**Property name:** `openjpa.jdbc.Schemas`

**Configuration API:** `org.apache.openjpa.jdbc.conf.JDBCConfiguration.getSchemas`

**Resource adaptor config-property:** `Schemas`

**Default:** `-`

**Description:** A comma-separated list of the schemas and/or tables used for your persistent data. See [Section 4.12.1, “Schemas List” \[267\]](#) for details.

---

## 2.6.15. openjpa.jdbc.SQLFactory

**Property name:** `openjpa.jdbc.SQLFactory`

**Configuration API:** `org.apache.openjpa.jdbc.conf.JDBCConfiguration.getSQLFactory`

**Resource adaptor config-property:** `SQLFactory`

**Default:** `default`

**Description:** A plugin string (see [Section 2.4, “Plugin Configuration” \[210\]](#)) describing the `org.apache.openjpa.jdbc.sql.SQLFactory` to use to abstract common SQL constructs.

---

## 2.6.16. openjpa.jdbc.SubclassFetchMode

**Property name:** `openjpa.jdbc.SubclassFetchMode`

**Configuration API:** `org.apache.openjpa.jdbc.conf.JDBCConfiguration.getSubclassFetchMode`

**Resource adaptor config-property:** `SubclassFetchMode`

**Default:** `parallel`

**Possible values:** `parallel, join, none`

**Description:** How to select subclass data when it is in other tables. This setting can also be varied at runtime. See [Section 5.8, “Eager Fetching” \[294\]](#).

---

## 2.6.17. openjpa.jdbc.SynchronizeMappings

**Property name:** `openjpa.jdbc.SynchronizeMappings`

**Configuration API:** `org.apache.openjpa.jdbc.conf.JDBCConfiguration.getSynchronizeMappings`

**Resource adaptor config-property:** `SynchronizeMappings`

**Default:** -

**Description:** Controls whether OpenJPA will attempt to run the mapping tool on all persistent classes to synchronize their mappings and schema at runtime. Useful for rapid test/debug cycles. See [Section 7.1.3, “Runtime Forward Mapping”](#) [306] for more information.

## 2.6.18. openjpa.jdbc.TransactionIsolation

---

**Property name:** `openjpa.jdbc.TransactionIsolation`

**Configuration API:** `org.apache.openjpa.jdbc.conf.JDBCConfiguration.getTransactionIsolation`

**Resource adaptor config-property:** `TransactionIsolation`

**Default:** `default`

**Possible values:** `default, none, read-committed, read-uncommitted, repeatable-read, serializable`

**Description:** The JDBC transaction isolation level to use. See [Section 4.5, “Setting the Transaction Isolation”](#) [261] for details.

## 2.6.19. openjpa.jdbc.UpdateManager

---

**Property name:** `openjpa.jdbc.UpdateManager`

**Configuration API:** `org.apache.openjpa.jdbc.conf.JDBCConfiguration.getUpdateManager`

**Resource adaptor config-property:** `UpdateManager`

**Default:** `batching-constraint`

**Possible values:** `default, operation-order, constraint, batching-constraint, batching-operation-order`

**Description:** The full class name of the `org.apache.openjpa.jdbc.kernel.UpdateManager` to use to flush persistent object changes to the datastore. The provided default implementation is `org.apache.openjpa.jdbc.kernel.BatchingConstraintUpdateManager`.

## 2.6.20. Compatibility with Specification

---

The default behavior of certain OpenJPA API methods can evolve to align with the behaviors defined in JPA specification. To maintain backward compatibility, OpenJPA allows configuration options such that while the default behavior changes to align with current JPA specification, the previous behaviors can always be emulated.

For example, JPA 2.0 specification introduces a new API `void EntityManager.detach(Object entity)` that detaches the given entity from the current persistence context. OpenJPA has provided similar feature via `<T> T OpenJPAEntityManager.detach(T entity)` prior to JPA 2.0. `OpenJPA.detach()`, however, has different default behavior than what JPA 2.0 specification mandates. Firstly, OpenJPA creates a copy of the given entity as a detached instance and returns it, whereas JPA 2.0 behavior requires the same given entity instance be detached. Secondly, the given instance is

removed from the persistence context for JPA 2.0, whereas OpenJPA `detach()` method, prior to JPA 2.0, does not remove the instance from the persistence context as a copy is returned. Thirdly, OpenJPA will flush before detaching a dirty instance so that the detached instance can later be merged, whereas JPA 2.0 `detach()` semantics does not require a dirty instance be flushed before detach.

A user application running with OpenJPA that is compliant to a specific version of JPA specification can emulate the older behavior by configuring OpenJPA compatibility options. For example, `openjpa.Compatibility=FlushBeforeDetach=false, CopyOnDetach=true` will emulate the older behavior of detach even when running with OpenJPA that is compliant to JPA 2.0 specification. The configuration can also be set to a different version of the specification. For example, `openjpa.Specification="JPA 1.0"` configuration setting will emulate default OpenJPA behavior as it were for JPA specification version 1.0. Setting `openjpa.Specification` is a shorthand for more fine-grained control available via `openjpa.Compatibility`.

---

# Chapter 3. Logging and Auditing

Logging is an important means of gaining insight into your application's runtime behavior. OpenJPA provides a flexible logging system that integrates with many existing runtime systems, such as application servers and servlet runners.

There are five built-in logging plugins: a **default logging framework** that covers most needs, a **Log4J** delegate, a **SLF4J** delegate, an **Apache Commons Logging** delegate, and a **no-op** implementation for disabling logging.

## Warning

Logging can have a negative impact on performance. Disable verbose logging (such as logging of SQL statements) before running any performance tests. It is advisable to limit or disable logging for a production system. You can disable logging altogether by setting the `openjpa.Log` property to `none`.

---

## 3.1. Logging Channels

Logging is done over a number of *logging channels*, each of which has a *logging level* which controls the verbosity of log messages recorded for the channel. OpenJPA uses the following logging channels:

- `openjpa.Tool`: Messages issued by the OpenJPA command line and Ant tools. Most messages are basic statements detailing which classes or files the tools are running on. Detailed output is only available via the logging category the tool belongs to, such as `openjpa.Enhance` for the enhancer (see [Section 5.2, “Enhancement” \[274\]](#)) or `openjpa.MetaData` for the mapping tool (see [Section 7.1, “Forward Mapping” \[304\]](#)). This logging category is provided so that you can get a general idea of what a tool is doing without having to manipulate logging settings that might also affect runtime behavior.
- `openjpa.Enhance`: Messages pertaining to enhancement and runtime class generation.
- `openjpa.MetaData`: Details about the generation of metadata and object-relational mappings.
- `openjpa.Runtime`: General OpenJPA runtime messages.
- `openjpa.Query`: Messages about queries. Query strings and any parameter values, if applicable, will be logged to the TRACE level at execution time. Information about possible performance concerns will be logged to the INFO level.
- `openjpa.DataCache`: Messages from the L2 data cache plugins.
- `openjpa.jdbc.JDBC`: JDBC connection information. General JDBC information will be logged to the TRACE level. Information about possible performance concerns will be logged to the INFO level.
- `openjpa.jdbc.SQL`: This is the most common logging channel to use. Detailed information about the execution of SQL statements will be sent to the TRACE level. It is useful to enable this channel if you are curious about the exact SQL that OpenJPA issues to the datastore.

## Note

The SQL issued to the database may contain sensitive information. By default the parameter values used in the prepared statements generated by OpenJPA will not be printed in the SQL log - instead you will see a ? for each value. The actual values may be printed by adding `PrintParameters=True` to the `openjpa.ConnectionFactoryProperties` property. Also see [Using the OpenJPA DataSource](#)

When using the built-in OpenJPA logging facilities, you can enable SQL logging by adding `SQL=TRACE` to your `openjpa.Log` property.



OpenJPA can optionally reformat the logged SQL to make it easier to read. To enable pretty-printing, add `PrettyPrint=true` to the `openjpa.ConnectionFactoryProperties` property. You can control how many columns wide the pretty-printed SQL will be with the `PrettyPrintLineLength` property. The default line length is 60 columns.

While pretty printing makes things easier to read, it can make output harder to process with tools like `grep`.

Pretty-printing properties configuration might look like so:

```
<property name="openjpa.Log" value="SQL=TRACE" />
<property name="openjpa.ConnectionFactoryProperties"
  value="PrettyPrint=true, PrettyPrintLineLength=72" />
```

- `openjpa.jdbc.SQLDiag`: This logging channel provides additional information about entity activities such as create, find, update or delete, and eager loading of relation or field properties. If you enable this channel, it is recommended that `openjpa.jdbc.SQL` channel is also enabled. The additional trace can help you relate the entity activities to the execution of SQL statements that OpenJPA issued to the datastore.

When using the built-in OpenJPA logging facilities, you can enable `SQLDiag` logging by adding `SQLDiag=TRACE` to your `openjpa.Log` property.

- `openjpa.jdbc.Schema`: Details about operations on the database schema.

## 3.2. OpenJPA Logging

By default, OpenJPA uses a basic logging framework with the following output format:

```
millis diagnostic context level [thread name] channel - message
```

For example, when loading an application that uses OpenJPA, a message like the following will be sent to the `openjpa.Runtime` channel:

```
2107 INFO [main] openjpa.Runtime - Starting OpenJPA 2.2.0
```

The default logging system accepts the following parameters:

- `File`: The name of the file to log to, or `stdout` or `stderr` to send messages to standard out and standard error, respectively. By default, OpenJPA sends log messages to standard error.
- `DefaultLevel`: The default logging level of unconfigured channels. Recognized values are `TRACE`, `INFO`, `WARN`, `ERROR` and `FATAL`. Defaults to `INFO`.
- `DiagnosticContext`: A string that will be prepended to all log messages. If this is not supplied and an `openjpa.Id` property value is available, that value will be used.
- `<channel>`: Using the last token of the **logging channel** name, you can configure the log level to use for that channel. See the examples below.

### *Example 3.1. Standard OpenJPA Log Configuration*

```
<property name="openjpa.Log" value="DefaultLevel=WARN, Runtime=INFO, Tool=INFO"/>
```

### *Example 3.2. Standard OpenJPA Log Configuration + All SQL Statements*

```
<property name="openjpa.Log" value="DefaultLevel=WARN, Runtime=INFO, Tool=INFO, SQL=TRACE"/>
```

### *Example 3.3. Logging to a File*

```
<property name="openjpa.Log" value="File=/tmp/org.apache.openjpa.log, DefaultLevel=WARN, Runtime=INFO, Tool=INFO"/>
```

## 3.3. Disabling Logging

Disabling logging can be useful to analyze performance without any I/O overhead or to reduce verbosity at the console. To do this, set the `openjpa.Log` property to `none`.

Disabling logging permanently, however, will cause all warnings to be consumed. We recommend using one of the more sophisticated mechanisms described in this chapter.

## 3.4. Log4J

When `openjpa.Log` is set to `log4j`, OpenJPA will delegate to Log4J for logging. In a standalone application, Log4J logging levels are controlled by a resource named `log4j.properties`, which should be available as a top-level resource (either at the top level of a jar file, or in the root of one of the CLASSPATH directories). When deploying to a web or EJB application server, Log4J configuration is often performed in a `log4j.xml` file instead of a properties file. For further details on configuring Log4J, please see the [Log4J Manual](#). We present an example `log4j.properties` file below.

### *Example 3.4. Standard Log4J Logging*

```
log4j.rootCategory=WARN, console
log4j.category.openjpa.Tool=INFO
log4j.category.openjpa.Runtime=INFO
log4j.category.openjpa.Remote=WARN
log4j.category.openjpa.DataCache=WARN
log4j.category.openjpa.MetaData=WARN
log4j.category.openjpa.Enhance=WARN
log4j.category.openjpa.Query=WARN
log4j.category.openjpa.jdbc.SQL=WARN
log4j.category.openjpa.jdbc.SQLDiag=WARN
log4j.category.openjpa.jdbc.JDBC=WARN
log4j.category.openjpa.jdbc.Schema=WARN

log4j.appender.console=org.apache.log4j.ConsoleAppender
```

## 3.5. Apache Commons Logging

Set the `openjpa.Log` property to `commons` to use the [Apache Commons Logging](#) thin library for issuing log messages. The Commons Logging library act as a wrapper around a number of popular logging APIs, including the [Jakarta Log4J](#) project, and the native [java.util.logging](#) package in JDK.

When using the Commons Logging framework in conjunction with Log4J, configuration will be the same as was discussed in the Log4J section above.

### 3.5.1. JDK `java.util.logging`

When using JDK logging in conjunction with OpenJPA's Commons Logging support, logging will proceed through Java's built-in logging provided by the `java.util.logging` package. For details on configuring the built-in logging system, please see the [Java Logging Overview](#).

By default, JDK's logging package looks in the `JAVA_HOME/lib/logging.properties` file for logging configuration. This can be overridden with the `java.util.logging.config.file` system property. For example:

```
java -Djava.util.logging.config.file=mylogging.properties com.company.MyClass
```

#### *Example 3.5. JDK Log Properties*

```
# specify the handlers to create in the root logger
# (all loggers are children of the root logger)
# the following creates two handlers
handlers=java.util.logging.ConsoleHandler, java.util.logging.FileHandler

# set the default logging level for the root logger
.level=ALL

# set the default logging level for new ConsoleHandler instances
java.util.logging.ConsoleHandler.level=INFO

# set the default logging level for new FileHandler instances
java.util.logging.FileHandler.level=ALL

# set the default formatter for new ConsoleHandler instances
java.util.logging.ConsoleHandler.formatter=java.util.logging.SimpleFormatter

# set the default logging level for all OpenJPA logs
openjpa.Tool.level=INFO
openjpa.Runtime.level=INFO
openjpa.Remote.level=INFO
openjpa.DataCache.level=INFO
openjpa.Metadata.level=INFO
openjpa.Enhance.level=INFO
openjpa.Query.level=INFO
openjpa.jdbc.SQL.level=INFO
openjpa.jdbc.SQLDiag.level=INFO
openjpa.jdbc.JDBC.level=INFO
openjpa.jdbc.Schema.level=INFO
```

## 3.6. SLF4J

When `openjpa.Log` is set to `slf4j`, OpenJPA will delegate to SLF4J API for logging, which provides several adapters or a simple logging mechanism. For further details on logging adapters and configuring SLF4J, please see the [SLF4J website](#).

Note, as SLF4J does not provide a FATAL log level the `SLF4JLogFactory` will map it to the ERROR log level.

## 3.7. Custom Log

If none of available logging systems meet your needs, you can configure the logging system with a custom logger. You might use custom logging to integrate with a proprietary logging framework used by some applications servers, or for logging to a graphical component for GUI applications.

A custom logging framework must include an implementation of the `org.apache.openjpa.lib.log.LogFactory` interface. We present a custom `LogFactory` below.

### Example 3.6. Custom Logging Class

```
package com.xyz;

import org.apache.openjpa.lib.log.*;

public class CustomLogFactory
    implements LogFactory {

    private String _prefix = "CUSTOM LOG";

    public void setPrefix(String prefix) {
        _prefix = prefix;
    }

    public Log getLog(String channel) {
        // Return a simple extension of AbstractLog that will log
        // everything to the System.err stream. Note that this is
        // roughly equivalent to OpenJPA's default logging behavior.
        return new AbstractLog() {

            protected boolean isEnabled(short logLevel) {
                // log all levels
                return true;
            }

            protected void log(short type, String message, Throwable t) {
                // just send everything to System.err
                System.err.println(_prefix + ": " + type + ": "
                    + message + ": " + t);
            }
        };
    }
}
```

To make OpenJPA use your custom log factory, set the `openjpa.Log` configuration property to your factory's full class name. Because this property is a plugin property (see [Section 2.4, “Plugin Configuration” \[210\]](#)), you can also pass parameters to your factory. For example, to use the example factory above and set its prefix to "LOG MSG", you would set the `openjpa.Log` property to the following string:

```
com.xyz.CustomLogFactory(Prefix="LOG MSG")
```

## 3.8. OpenJPA Audit

Transactional applications often require to audit changes in persistent objects. OpenJPA can enable audit facility for all persistent entities in few simple steps.

### 3.8.1. Configuration

*Annotate Persistent Entity* Any persistence entity can be enabled for audit by annotating with `org.apache.openjpa.audit.Auditable`.

```
@javax.persistence.Entity
@org.apache.openjpa.audit.Auditable
public class MyDomainObject { ...}
```

This `Auditable` annotation enables auditing of creation, update or delete of `MyDomainObject` instances. The `Auditable` annotation accepts list of enumerated values `org.apache.openjpa.audit.AuditableOperation` namely `CREATE`, `UPDATE` and `DELETE` to customize only appropriate operations be audited. By default, all of the above operations are audited.

*Configure Persistence Configuration* The audit facility is invoked at runtime via configuration of `META-INF/persistence.xml`. The following property configures auditing via a default auditor

```
<property name="openjpa.Auditor" value="default"/>
```

The default auditor does not do much. It simply prints each auditable instance with its latest and original states on a standard console (or to a designated file).

The *latest* state of an instance designates the state which is committed to the database. The *original* state designates the state when the instance entered the managed persistent context. For example, when a new instance is persisted or a existing instance is loaded from the database.

## 3.8.2. Developing custom auditing

For real use case, an application will prefer more than printing the changed instances. The application, in such case, needs to implement `org.apache.openjpa.audit.Auditor` interface. This simple interface has the following method:

```
/**
 * OpenJPA runtime will invoke this method with the given parameters
 * within a transaction.
 *
 * @param broker the active persistence context.
 * @param newObjects the set of auditable objects being created. Can be empty, but never null.
 * @param updates the set of auditable objects being updated. Can be empty, but never null.
 * @param deletes the set of auditable objects being deleted. Can be empty, but never null.
 */
public void audit(Broker broker, Collection<Audited> newObjects, Collection<Audited> updates,
    Collection<Audited> deletes);
```

OpenJPA runtime will invoke this method *before* database commit. Via this callback method, the application receives the auditable instances in three separate collections of `org.apache.openjpa.audit.Auditable`. An `Auditable` instance provides the latest and original state of a persistent object. The latest object is the same persistent instance to be committed. The original instance is a transient instance holding the original state of the instance when it entered the managed context. The active persistence context is also supplied in this callback method, so that an application may decide to persist the audit log in the same database.

It is important to note that the original object can not be persisted in the same transaction, because it has the same persistent identity of the latest object.

A single instance of implemented `org.apache.openjpa.audit.Auditor` interface is available for a persistence unit. However, an application's own implementation of this interface need not be thread-safe, because OpenJPA runtime guards against concurrent invocation of the callback method.

The `org.apache.openjpa.audit.Auditor` interface is configurable. Hence any bean style getter and setter method on its implementation will be populated as usual for any other OpenJPA plugin. In the following example,

```
<property name="openjpa.Auditor" value="com.acme.Auditor(param2=10,param2='hello')"/>
```

An instance of `com.acme.Auditor` will be instantiated and if it has been style getter and setter methods for `param1` and `param2`, then the respective setters will be called with 10 and "hello" before the instance being used.

---

# Chapter 4. JDBC

OpenJPA uses a relational database for object persistence. It communicates with the database using the Java DataBase Connectivity (JDBC) APIs. This chapter describes how to configure OpenJPA to work with the JDBC driver for your database, and how to access JDBC functionality at runtime.

## 4.1. Using the OpenJPA DataSource

---

OpenJPA defines a `org.apache.openjpa.jdbc.schema.DriverDataSource` interface, which provides a simple `javax.sql.DataSource` wrapper implementation for the normal cases where `openjpa.ConnectionDriverName` refers to a `java.sql.Driver`. See [openjpa.jdbc.DriverDataSource](#) for the list of provided implementations.

### 4.1.1. Optional Connection Pooling

---

Starting with OpenJPA 2.1, a new `org.apache.openjpa.jdbc.schema.AutoDriverDataSource` is provided as the default, which will automatically select between the old `SimpleDriverDataSource` and a new `DBCPDriverDataSource` implementation based on if **Apache Commons DBCP** has been provided on the classpath and OpenJPA is not running in a container managed mode or with managed transactions. Note, that only the `openjpa-all.jar` includes Commons DBCP, so you will need to include the `commons-dbc.jar` from the OpenJPA binary distribution if you are using the normal `openjpa.jar`.

To disable the automatic usage of Apache Commons DBCP when it is discovered on the classpath, set `openjpa.jdbc.DriverDataSource=simple`, which will revert OpenJPA to the prior behavior of using `org.apache.openjpa.jdbc.schema.SimpleDriverDataSource`

To force usage of Apache Commons DBCP, which will cause a fatal exception to be thrown if it cannot be loaded from the classpath, set `openjpa.jdbc.DriverDataSource=dbcp`, which will cause OpenJPA to use `org.apache.openjpa.jdbc.schema.DBCPDriverDataSource`

### 4.1.2. Configuring the OpenJPA DataSource

---

If you choose to use OpenJPA's `DataSource`, then you must specify the following properties:

- `openjpa.ConnectionUserName`: The JDBC user name for connecting to the database.
- `openjpa.ConnectionPassword`: The JDBC password for the above user.
- `openjpa.ConnectionURL`: The JDBC URL for the database.
- `openjpa.ConnectionDriverName`: The JDBC driver class.

To configure advanced features, use the following optional properties. The syntax of these property strings follows the syntax of OpenJPA plugin parameters described in [Section 2.4, “Plugin Configuration” \[210\]](#).

- **openjpa.ConnectionProperties**: If the listed driver is an instance of `java.sql.Driver`, this string will be parsed into a `Properties` instance, which will then be used to obtain database connections through the `Driver.connect(String url, Properties props)` method. If, on the other hand, the listed driver is a `javax.sql.DataSource`, the string will be treated as a plugin properties string, and matched to the bean setter methods of the `DataSource` instance.
- **openjpa.ConnectionFactoryProperties**: OpenJPA's built-in `DataSource` allows you to set the following options via this plugin string:

- `QueryTimeout`: The maximum number of seconds the JDBC driver will wait for a statement to execute.
- `PrettyPrint`: Boolean indicating whether to pretty-print logged SQL statements.
- `PrettyPrintLineLength`: The maximum number of characters in each pretty-printed SQL line.
- `PrintParameters`: A boolean indicating whether SQL parameter values will be included in exception text and when logging is enabled. Since the parameter values may contain sensitive information the default value is false.

#### *Example 4.1. Properties for the OpenJPA DataSource*

```
<property name="openjpa.ConnectionUserName" value="user"/>
<property name="openjpa.ConnectionPassword" value="pass"/>
<property name="openjpa.ConnectionURL" value="jdbc:hsqldb:db-hypersonic"/>
<property name="openjpa.ConnectionDriverName" value="org.hsqldb.jdbcDriver"/>
<property name="openjpa.ConnectionFactoryProperties"
  value="PrettyPrint=true, PrettyPrintLineLength=80, PrintParameters=true"/>
```

### 4.1.3. Configuring Apache Commons DBCP

Additional Commons DBCP arguments can be provided in `openjpa.connectionProperties`, such as:

```
MaxActive=10,MaxIdle=5,MinIdle=2,MaxWait=60000
```

Please visit the Commons DBCP website for the entire list of **configuration options** and explanations.

## 4.2. Using a Third-Party DataSource

You can use OpenJPA with any third-party `javax.sql.DataSource`. There are multiple ways of telling OpenJPA about a `DataSource`:

- Set the `DataSource` into the map passed to `Persistence.createEntityManagerFactory` under the `openjpa.ConnectionFactory` key.
- Bind the `DataSource` into JNDI, and then specify its location in the `jta-data-source` or `non-jta-data-source` element of the **JPA XML format** (depending on whether the `DataSource` is managed by JTA), or in the `openjpa.ConnectionFactoryName` property.
- Specify the full class name of the `DataSource` implementation in the `openjpa.ConnectionDriverName` property in place of a JDBC driver. In this configuration OpenJPA will instantiate an instance of the named class via reflection. It will then configure the `DataSource` with the properties in the `openjpa.ConnectionProperties` setting.

The features of OpenJPA's own `DataSource` can also be used with third-party implementations. OpenJPA layers on top of the third-party `DataSource` to provide the extra functionality. To configure these features use the `openjpa.ConnectionFactoryProperties` property described in the previous section.

#### *Example 4.2. Properties File for a Third-Party DataSource*



```
<property name="openjpa.ConnectionDriverName" value="oracle.jdbc.pool.OracleDataSource" />
<property name="openjpa.ConnectionProperties"
  value="PortNumber=1521, ServerName=saturn, DatabaseName=solarsid, DriverType=thin" />
<property name="openjpa.ConnectionFactoryProperties" value="QueryTimeout=5000" />
```

You can also force the Apache Commons DBCP BasicDataSource to be used for connection pooling when provided on the classpath by substituting it as the ConnectionDriverName and setting ConnectionProperties=DriverClassName to the actual JDBC driver value -

```
<property name="openjpa.ConnectionDriverName" value="org.apache.commons.dbcp.BasicDataSource" />
<property name="openjpa.ConnectionProperties"
  value="DriverClassName=oracle.jdbc.pool.OracleDataSource, PortNumber=1521, ServerName=saturn, DatabaseName=solarsid, DriverType=thin" />
<property name="openjpa.ConnectionFactoryProperties" value="QueryTimeout=5000" />
```

## 4.2.1. Managed and XA DataSources

Certain application servers automatically enlist their DataSource s in global transactions. When this is the case, OpenJPA should not attempt to commit the underlying connection, leaving JDBC transaction completion to the application server. To notify OpenJPA that your third-party DataSource is managed by the application server, use the `jta-data-source` element of your `persistence.xml` file or set the `openjpa.ConnectionFactoryMode` property to managed.

Note that OpenJPA can only use managed DataSources when it is also integrating with the application server's managed transactions. Also note that all XA DataSources are enlisted, and you must set this property when using any XA DataSource.

When using a managed DataSource, you should also configure a second unmanaged DataSource that OpenJPA can use to perform tasks that are independent of the global transaction. The most common of these tasks is updating the sequence table OpenJPA uses to generate unique primary key values for your datastore identity objects. Configure the second DataSource using the `non-jta-data-source` `persistence.xml` element, or OpenJPA's various "2" connection properties, such as `openjpa.ConnectionFactory2Name` or `openjpa.Connection2DriverName`. These properties are outlined in [Chapter 2, Configuration \[208\]](#).

### Example 4.3. Managed DataSource Configuration

```
<!-- managed DataSource -->
<jta-data-source>java://OracleXADataSource</jta-data-source>
<properties>
  <!-- use OpenJPA's built-in DataSource for unmanaged connections -->
  <property name="openjpa.Connection2UserName" value="scott"/>
  <property name="openjpa.Connection2Password" value="tiger"/>
  <property name="openjpa.Connection2URL" value="jdbc:oracle:thin:@CROM:1521:OpenJPADB"/>
  <property name="openjpa.Connection2DriverName" value="oracle.jdbc.driver.OracleDriver"/>
</properties>
```

## 4.2.2. Setting the DataSource at runtime

As mentioned above, the JTA and Non-JTA DataSources may be passed in as configuration properties at EntityManagerFactory creation. Either the JPA standard properties (`javax.persistence.jtaDataSource`, `java.persistence.nonJtaDataSource`) or their OpenJPA specific equivalents (`openjpa.ConnectionFactoryName`, `openjpa.ConnectionFactory2Name`) may be used. One use case for this function is to store production connection information in configuration files but override the value when testing.

**Example 4.4. Setting DataSource at Runtime**

```
Map<Object,Object> props = new HashMap<Object,Object>();
props.put("javax.persistence.jtaDataSource", "jdbc/myDataSource");
props.put("javax.persistence.nonJtaDataSource", "jdbc/myNonJTADatasource");
emf = Persistence.createEntityManagerFactory("example", props);
```

**4.2.2.1. Using different DataSources for each EntityManager**

The JPA specification allows the DataSource (ConnectionFactory) to be specified on the EntityManagerFactory. OpenJPA extends this support and allows each EntityManager to override the DataSource from the EntityManagerFactory. It's expected that the EntityManagerFactory will also be configured with a valid JTA / Non-JTA DataSource. The DataSource configured on the EntityManagerFactory will be used to obtain a DBDictionary and (rarely) to gather some information about the database in use (e.g. version, JDBC driver version).

If the EntityManagerFactory is not configured with a valid DataSource there are a few additional caveats.

- The `openjpa.DBDictionary` property must be used to ensure the correct DBDictionary is used.
- OpenJPA will always attempt to obtain a DataSource from JNDI based on the configuration for the EntityManagerFactory. When a JNDI name is specified on the EntityManager this lookup happens slightly earlier than normal. If the lookup fails the JNDI name provided at EntityManager creation will be set into the EntityManagerFactory's configuration and used in subsequent attempts.

**4.2.2.1.1. Benefits**

In effect this option allows a single set of entity definitions to be shared between multiple database instances or schemas within an instance. This can be highly beneficial when there are a large number of entity definitions (e.g. > 200), or a large number of databases / schemas in use.

**4.2.2.1.2. Limitations**

- The same database type and version must be used by each EntityManager. OpenJPA will use the same DBDictionary for each EntityManager and will make no attempt to alter SQL syntax between EntityManager instances.
- It is the application's responsibility to ensure that the schema is identical on each database.
- The application may not specify schema names for individual entities.
- The DataSource (ConnectionFactory) name may only be specified when the EntityManager is created. The DataSource may not be switched while an EntityManager is in use.
- The L2 cache (DataCache) should not be used if different DataSources are specified for each EntityManager
- SynchronizeMappings should not be used with this feature.
- Table and Sequence generators should not be used with this feature.
- It is not required, but is recommended that the `openjpa.DBDictionary` property be specified when using this feature

**4.2.2.1.3. Error handling**

If a JTA DataSource is not available when the EntityManager is created, an `IllegalArgumentException` will be thrown. The EntityManager will not fall back to the JTA DataSource defined in the configuration.

The same logic applies if a Non-JTA `DataSource` is not available when the `EntityManager` is created. OpenJPA will not fall back to the configured Non-JTA `DataSource`.

## 4.3. Runtime Access to DataSource

The JPA standard defines how to access JDBC connections from enterprise beans. OpenJPA also provides APIs to retrieve a connection directly from the `EntityManagerFactory`'s `DataSource`.

The `EntityManager.unwrap(java.sql.Connection.class)` method returns an `EntityManager`'s connection. If the `EntityManager` does not already have a connection, it will obtain one. The returned connection is only guaranteed to be transactionally consistent with other `EntityManager` operations if the `EntityManager` is in a managed or non-optimistic transaction, if the `EntityManager` has flushed in the current transaction, or if you have used the `OpenJPAEntityManager.beginStore` method to ensure that a datastore transaction is in progress. Always close the returned connection before attempting any other `EntityManager` operations. OpenJPA will ensure that the underlying native connection is not released if a datastore transaction is in progress.

### *Example 4.5. Using the EntityManager's Connection*

```
import java.sql.Connection;
import javax.persistence.EntityManager;
import javax.persistence.EntityManagerFactory;

...

EntityManager em = emf.createEntityManager();
Connection conn = (Connection) em.unwrap(java.sql.Connection.class);

// do JDBC stuff

conn.close();
```

The example below shows how to use a connection directly from the `DataSource`, rather than using an `EntityManager`'s connection.

### *Example 4.6. Using the EntityManagerFactory's DataSource*

```
import java.sql.*;
import javax.sql.*;
import org.apache.openjpa.conf.*;
import org.apache.openjpa.persistence.*;

...

OpenJPAEntityManagerFactory kemf = OpenJPAPersistence.cast(emf);
OpenJPAConfiguration conf = kemf.getConfiguration();
DataSource dataSource = (DataSource) conf.getConnectionFactory();
Connection conn = dataSource.getConnection();

// do JDBC stuff

conn.close();
```

## 4.4. Database Support

OpenJPA can take advantage of any JDBC 2.x compliant driver, making almost any major database a candidate for use. See our officially supported database list in [Appendix 2, Supported Databases \[394\]](#) for more information. Typically,

OpenJPA auto-configures its JDBC behavior and SQL dialect for your database, based on the values of your connection-related configuration properties.

If OpenJPA cannot detect what type of database you are using, or if you are using an unsupported database, you will have to tell OpenJPA what `org.apache.openjpa.jdbc.sql.DBDictionary` to use. The `DBDictionary` abstracts away the differences between databases. You can plug a dictionary into OpenJPA using the `openjpa.jdbc.DBDictionary` configuration property. The built-in dictionaries are listed below. If you are using an unsupported database, you may have to write your own `DBDictionary` subclass, a simple process.

- `access`: Dictionary for Microsoft Access. This is an alias for the `org.apache.openjpa.jdbc.sql.AccessDictionary` class.
- `db2`: Dictionary for IBM's DB2 database. This is an alias for the `org.apache.openjpa.jdbc.sql.DB2Dictionary` class.
- `derby`: Dictionary for the Apache Derby database. This is an alias for the `org.apache.openjpa.jdbc.sql.DerbyDictionary` class.
- `empress`: Dictionary for Empress database This is an alias for the `org.apache.openjpa.jdbc.sql.EmpressDictionary` class.
- `foxpro`: Dictionary for Microsoft Visual FoxPro. This is an alias for the `org.apache.openjpa.jdbc.sql.FoxProDictionary` class.
- `h2`: Dictionary for the H2 Database Engine. This is an alias for the `org.apache.openjpa.jdbc.sql.H2Dictionary` class.
- `hsqldb`: Dictionary for the Hypersonic SQL database. This is an alias for the `org.apache.openjpa.jdbc.sql.HSQLDictionary` class.
- `informix`: Dictionary for the Informix database. This is an alias for the `org.apache.openjpa.jdbc.sql.InformixDictionary` class.
- `ingres`: Dictionary for Ingres. This is an alias for the `org.apache.openjpa.jdbc.sql.IngresDictionary` class.
- `jdatastore`: Dictionary for Borland JDataStore. This is an alias for the `org.apache.openjpa.jdbc.sql.JDataStoreDictionary` class.
- `mariadb`: Dictionary for the MariaDB database. This is an alias for the `org.apache.openjpa.jdbc.sql.MariaDBDictionary` class.
- `mysql`: Dictionary for the MySQL database. This is an alias for the `org.apache.openjpa.jdbc.sql.MySQLDictionary` class.
- `oracle`: Dictionary for Oracle. This is an alias for the `org.apache.openjpa.jdbc.sql.OracleDictionary` class.
- `pointbase`: Dictionary for Pointbase Embedded database. This is an alias for the `org.apache.openjpa.jdbc.sql.PointbaseDictionary` class.
- `postgres`: Dictionary for PostgreSQL. This is an alias for the `org.apache.openjpa.jdbc.sql.PostgresDictionary` class.
- `soliddb`: Dictionary for IBM's SolidDB database. This is an alias for the `org.apache.openjpa.jdbc.sql.SolidDBDictionary` class.
- `sqlserver`: Dictionary for Microsoft's SQL Server database. This is an alias for the `org.apache.openjpa.jdbc.sql.SQLServerDictionary` class.

- `sybase`: Dictionary for Sybase. This is an alias for the `org.apache.openjpa.jdbc.sql.SybaseDictionary` class.

The example below demonstrates how to set a dictionary and configure its properties in your configuration file. The `DBDictionary` property uses OpenJPA's **plugin syntax**.

#### *Example 4.7. Specifying a DBDictionary*

```
<property name="openjpa.jdbc.DBDictionary" value="hsql(SimulateLocking=true)"/>
```

### 4.4.1. DBDictionary Properties

The standard dictionaries all recognize the following properties. These properties will usually not need to be overridden, since the dictionary implementation should use the appropriate default values for your database. You typically won't use these properties unless you are designing your own `DBDictionary` for an unsupported database.

- `AllowsAliasInBulkClause`: When true, SQL delete and update statements may use table aliases.
- `ArrayTypeNames`: The overridden default column type for `java.sql.Types.ARRAY`. This is used only when the schema is generated by the `mappingtool`.
- `AutoAssignClause`: The column definition clause to append to a creation statement. For example, "AUTO\_INCREMENT" for MySQL. This property is set automatically in the dictionary, and should not need to be overridden, and is only used when the schema is generated using the `mappingtool`.
- `AutoAssignTypeName`: The column type name for auto-increment columns. For example, "BIGSERIAL" for PostgreSQL. This property is set automatically in the dictionary and should not need to be overridden. It is used only when the schema is generated using the `mappingtool`.
- `BatchLimit`: The default batch limit for sending multiple SQL statements at once to the database. A value of -1 indicates unlimited batching, and any positive integer indicates the maximum number of SQL statements to batch together. Defaults to 0 which disables batching.
- `BigintTypeName`: The overridden default column type for `java.sql.Types.BIGINT`. This is used only when the schema is generated by the `mappingtool`.
- `BinaryTypeName`: The overridden default column type for `java.sql.Types.BINARY`. This is used only when the schema is generated by the `mappingtool`.
- `BitTypeName`: The overridden default column type for `java.sql.Types.BIT`. This is used only when the schema is generated by the `mappingtool`.
- `BlobBufferSize`: This property establishes the buffer size in the INSERT/UPDATE operations with an `java.io.InputStream`. This is only used with OpenJPA's **Section 7.7.11, "LOB Streaming" [327]**. Defaults to 50000.
- `BlobTypeName`: The overridden default column type for `java.sql.Types.BLOB`. This is used only when the schema is generated by the `mappingtool`.
- `BooleanRepresentation`: The overridden default representation for `java.lang.Boolean` or `boolean` fields in JPA Entities. A `org.apache.openjpa.jdbc.sql.BooleanRepresentation` describes how Boolean values in entities get mapped into the database by default. Note that you additionally might need to define the `BooleanTypeName` `BitTypeName` settings to fit your selected `BooleanRepresentation`.

- `BooleanTypeName`: The overridden default column type for `java.sql.Types.BOOLEAN`. This is used only when the schema is generated by the mappingtool.
- `CastFunction`: The SQL function call to cast a value to another SQL type. Use the tokens `{0}` and `{1}` to represent the two arguments. The result of the function is convert the `{0}` value to a `{1}` type. The default is `"CAST({0} AS {1})"`.
- `CatalogSeparator`: The string the database uses to delimit between the schema name and the table name. This is typically `"."`, which is the default.
- `CharTypeName`: The overridden default column type for `java.sql.Types.CHAR`. This is used only when the schema is generated by the mappingtool.
- `CharacterColumnSize`: The default size of `varchar` and `char` columns. Typically 255.
- `ClobBufferSize`: This property establish the buffer size in the `INSERT/UPDATE` operations with a `java.io.Reader`. This is only used with OpenJPA's [Section 7.7.11, “LOB Streaming” \[327\]](#). Defaults to 50000.
- `ClobTypeName`: The overridden default column type for `java.sql.Types.CLOB`. This is used only when the schema is generated by the mappingtool.
- `ClosePoolSQL`: A special command to issue to the database when shutting down the pool. Usually the pool of connections to the database is closed when the application is ending. For embedded databases, whose lifecycle is coterminous with the application, there may be a special command, usually `"SHUTDOWN"`, that will cause the embedded database to close cleanly. Defaults to `null`.
- `ConcatenateFunction`: The SQL function call or operation to concatenate two strings. Use the tokens `{0}` and `{1}` to represent the two arguments. The result of the function or operation is to concatenate the `{1}` string to the end of the `{0}` string. Defaults to `"({0}||{1})"`.
- `ConstraintNameMode`: When creating constraints, whether to put the constraint name before the definition (`"before"`), just after the constraint type name (`"mid"`), or after the constraint definition (`"after"`). Defaults to `"before"`.
- `CreatePrimaryKeys`: When false, do not create database primary keys for identifiers. Defaults to `true`.
- `CrossJoinClause`: The clause to use for a cross join (cartesian product). Defaults to `"CROSS JOIN"`.
- `CurrentDateFunction`: The SQL function call to obtain the current date from the database. Defaults to `"CURRENT_DATE"`.
- `CurrentTimeFunction`: The SQL function call to obtain the current time from the database. Defaults to `"CURRENT_TIME"`.
- `CurrentTimestampFunction`: The SQL function call to obtain the current timestamp from the database. Defaults to `"CURRENT_TIMESTAMP"`.
- `DatePrecision`: The database is able to store time values to this degree of precision, which is expressed in nanoseconds. This value is usually one million, meaning that the database is able to store time values with a precision of one millisecond. Particular databases may have more or less precision. OpenJPA will round all time values to this degree of precision before storing them in the database. This property can be set to one of the following precisions:
  - `DECI`: 100000000
  - `CENIT`: 10000000
  - `MILLI` (default precision): 1000000
  - `MICRO`: 1000

- `NANO` (max precision): 1
- `DateMillisecondBehavior`: When retrieving a `Date` value from a database which stores the value in a `TIMESTAMP` column, the values retrieved will be rounded to the nearest millisecond. So a date of '2010-01-01 12:00:00.687701' stored in the database will become '2010-01-01 12:00:00.688' in the `Date` field of the entity. The following date stored in the database as '9999-12-31 23:59:59.9999' will become '10000-01-01 00:00:00.000'. This rounding may not be desirable. With this property, a user has options which will direct OpenJPA how to handle the milliseconds. This property can be set to one of the enums defined in `DBDictionary.DateMillisecondBehaviors`. The options defined in `DBDictionary.DateMillisecondBehaviors` are as follows:
  - `DateMillisecondBehaviors.ROUND`: This is the default. The `Date` will be rounded to the nearest millisecond, as described above.
  - `DateMillisecondBehaviors.DROP`: The milliseconds will be dropped, thus rounding is not performed. As an example, a date of '2010-01-01 12:00:00.687701' stored in the database will become '2010-01-01 12:00:00.000' in the `Date` field of the entity.
  - `DateMillisecondBehaviors.RETAIN`: The milliseconds will not be rounded, but will be retained. As an example, a date of '2010-01-01 12:00:00.687701' stored in the database will become '2010-01-01 12:00:00.687' in the `Date` field of the entity.
- `DateTypeName`: The overridden default column type for `java.sql.Types.DATE`. This is used only when the schema is generated by the `mappingtool`.
- `DecimalTypeName`: The overridden default column type for `java.sql.Types.DECIMAL`. This is used only when the schema is generated by the `mappingtool`.
- `DelimitedCase`: The case to use when querying the database about identifiers that have been delimited. It defaults to preserving the case of the originally specified name. Available values are: `upper`, `lower`, `preserve`.
- `DisableAlterSequenceIncrementBy`: OpenJPA attempts to execute an `ALTER SEQUENCE...INCREMENT BY SQL` statement for a user defined sequence. This is done to ensure that the 'allocationSize' value defined by the entity's sequence, or default value, matches the sequence defined in the database. For example, with an allocationSize of 1000 for a sequence named 'SEQ\_JPASAMPLE', the following SQL will be generated (the SQL might vary slightly depending on the databases): `ALTER SEQUENCE SEQ_JPASAMPLE INCREMENT BY 1000`. If the user executing this command doesn't have permissions to execute the command, it will fail and in turn OpenJPA will disable sequence caching. If a user wants to disable this SQL command, this property can be set to true. However, the user must ensure that the entities defined sequence is kept in synch with the sequence defined in the database. Defaults to false.
- `DisableSchemaFactoryColumnTypeErrors`: When something other than the default `SchemaFactory` is used, up-front mapping validation is performed against the database schema. As part of the validation, OpenJPA will verify a persistence class column's type against the column type defined in the database schema. If a mismatch is found, OpenJPA will throw an exception to flag the mismatch types and will not allow processing to continue. This can be limiting, especially if the JDBC driver and/or database can properly handle the mismatch. Set this property to true to disable column type mismatch errors. Defaults to false.
- `DistinctCountColumnSeparator`: The string the database uses to delimit between column expressions in a `SELECT COUNT(DISTINCT column-list)` clause. Defaults to `null` for most databases, meaning that multiple columns in a distinct `COUNT` clause are not supported.
- `DistinctTypeName`: The overridden default column type for `java.sql.Types.DISTINCT`. This is used only when the schema is generated by the `mappingtool`.
- `DoubleTypeName`: The overridden default column type for `java.sql.Types.DOUBLE`. This is used only when the schema is generated by the `mappingtool`.



- `DriverVendor`: The vendor of the particular JDBC driver you are using. Some dictionaries must alter their behavior depending on the driver vendor. Dictionaries usually detect the driver vendor and set this property themselves. See the `VENDOR_XXX` constants defined in the `DBDictionary` Javadoc for available options.
- `DropTableSQL`: The SQL statement used to drop a table. Use the token `{0}` as the argument for the table name. Defaults to `"DROP TABLE {0}"`.
- `FixedSizeTypeNames`: A comma separated list of additional database types that have a size defined by the database. In other words, when a column of a fixed size type is declared, its size cannot be defined by the user. Common examples would be `DATE`, `FLOAT`, and `INTEGER`. Each database dictionary has its own internal set of fixed size type names that include the names mentioned here and many others. Names added to this property are added to the dictionary's internal set. Defaults to `null`.
- `FloatTypeName`: The overridden default column type for `java.sql.Types.FLOAT`. This is used only when the schema is generated by the `mappingtool`.
- `ForUpdateClause`: The clause to append to `SELECT` statements to issue queries that obtain pessimistic locks. Defaults to `"FOR UPDATE"`.
- `GetStringVal`: A special function to return the value of an XML column in a select statement. For example, Oracle uses `".getClobVal()"`, as in `"SELECT t0.xmlcol.getClobVal() FROM xmltab t0"`. Defaults to the empty string.
- `InClauseLimit`: The maximum number of elements in an `IN` clause. OpenJPA works around cases where the limit is exceeded. Defaults to `-1` meaning no limit.
- `InitializationSQL`: A piece of SQL to issue against the database whenever a connection is retrieved from the `DataSource`.
- `InnerJoinClause`: The clause to use for an inner join. Defaults to `"INNER JOIN"`.
- `IntegerTypeName`: The overridden default column type for `java.sql.Types.INTEGER`. This is used only when the schema is generated by the `mappingtool`.
- `JavaObjectTypeName`: The overridden default column type for `java.sql.Types.JAVAOBJECT`. This is used only when the schema is generated by the `mappingtool`.
- `JoinSyntax`: The SQL join syntax to use in select statements. See [Section 4.6, “Setting the SQL Join Syntax” \[261\]](#).
- `LastGeneratedKeyQuery`: The query to issue to obtain the last automatically generated key for an auto-increment column. For example, `"SELECT LAST_INSERT_ID()"` for MySQL. This property is set automatically in the dictionary, and should not need to be overridden. If `SupportsGetGeneratedKeys` is true, the query will not be issued but a more efficient JDBC 3.0 mechanism for obtaining generated keys will be used instead.
- `LeadingDelimiter`: The characters to use as the leading delimiter for a delimited identifier. The default value is a double quote, `( " )`. See [Section 4.4.7, “Delimited Identifiers Support” \[260\]](#) for the default value for some specific databases.
- `LongVarbinaryTypeName`: The overridden default column type for `java.sql.Types.LONGVARBINARY`. This is used only when the schema is generated by the `mappingtool`.
- `LongVarcharTypeName`: The overridden default column type for `java.sql.Types.LONGVARCHAR`. This is used only when the schema is generated by the `mappingtool`.
- `MaxAutoAssignNameLength`: Set this property to the maximum length of the sequence name used for auto-increment columns. Names longer than this value are truncated. Defaults to `31`.
- `MaxColumnNameLength`: The maximum number of characters in a column name. Defaults to `128`.



- `MaxConstraintNameLength`: The maximum number of characters in a constraint name. Defaults to 128.
- `MaxEmbeddedBlobSize`: When greater than -1, the maximum size of a BLOB value that can be sent directly to the database within an insert or update statement. Values whose size is greater than `MaxEmbeddedBlobSize` force OpenJPA to work around this limitation. A value of -1 means that there is no limitation. Defaults to -1.
- `MaxEmbeddedClobSize`: When greater than -1, the maximum size of a CLOB value that can be sent directly to the database within an insert or update statement. Values whose size is greater than `MaxEmbeddedClobSize` force OpenJPA to work around this limitation. A value of -1 means that there is no limitation. Defaults to -1.
- `MaxIndexNameLength`: The maximum number of characters in an index name. Defaults to 128.
- `MaxIndexesPerTable`: The maximum number of indexes that can be placed on a single table. Defaults to no limit.
- `MaxTableNameLength`: The maximum number of characters in a table name. Defaults to 128.
- `NameConcatenator`: The value used when names are concatenated to create a generated name. The default value is the underscore `"_"`.
- `NextSequenceQuery`: A SQL string for obtaining a native sequence value. May use a placeholder of `{0}` for the variable sequence name and `{1}` for sequence increment. Defaults to a database-appropriate value. For example, `"SELECT {0}.NEXTVAL FROM DUAL"` for Oracle database.
- `NullTypeName`: The overridden default column type for `java.sql.Types.NULL`. This is used only when the schema is generated by the mappingtool.
- `NumericTypeName`: The overridden default column type for `java.sql.Types.NUMERIC`. This is used only when the schema is generated by the mappingtool.
- `OtherTypeName`: The overridden default column type for `java.sql.Types.OTHER`. This is used only when the schema is generated by the mappingtool.
- `OuterJoinClause`: The clause to use for an left outer join. Defaults to `"LEFT OUTER JOIN"`.
- `Platform`: The name of the database that this dictionary targets. Defaults to `"Generic"`, but all dictionaries override this value.
- `RangePosition`: Indicates where to specify in the SQL select statement the range, if any, of the result rows to be returned. When limiting the number of returned result rows to a subset of all those that satisfy the query's conditions, the position of the range clause varies by database. Defaults to 0, meaning that the range is expressed at the end of the select statement but before any locking clause. See the `RANGE_XXX` constants defined in `DBDictionary`.
- `RealTypeName`: The overridden default column type for `java.sql.Types.REAL`. This is used only when the schema is generated by the mappingtool.
- `RefTypeName`: The overridden default column type for `java.sql.Types.REF`. This is used only when the schema is generated by the mappingtool.
- `RequiresAliasForSubselect`: When true, the database requires that subselects in a FROM clause be assigned an alias.
- `RequiresAutoCommitForMetadata`: When true, the JDBC driver requires that autocommit be enabled before any schema interrogation operations can take place.
- `RequiresCastForComparisons`: When true, comparisons of two values of different types or of two literals requires a cast in the generated SQL. Defaults to `false`.
- `RequiresCastForMathFunctions`: When true, math operations on two values of different types or on two literals requires a cast in the generated SQL. Defaults to `false`.

- `RequiresConditionForCrossJoin`: Some databases require that there always be a conditional statement for a cross join. If set, this parameter ensures that there will always be some condition to the join clause.
- `RequiresTargetForDelete`: When true, the database requires a target for delete statements. Defaults to `false`.
- `ReservedWords`: A comma-separated list of reserved words for this database, beyond the standard SQL92 keywords.
- `SchemaCase`: The case to use when querying the database metadata about schema components. Defaults to making all names upper case. Available values are: `upper`, `lower`, `preserve`.
- `SearchStringEscape`: The default escape character used when generating SQL `LIKE` clauses. The escape character is used to escape the wildcard meaning of the `_` and `%` characters. Note: since JPQL provides the ability to define the escape character in the query, this setting is primarily used when translating other query languages, such as JDOQL. Defaults to `"\\\"` (a single backslash in Java speak).
- `RequiresSearchStringEscapeForLike`: When true, the database requires an escape string for queries that use `LIKE`. The escape string can be specified using `searchStringEscape`. Defaults to `false`.
- `SelectWords`: A comma-separated list of keywords which may be used to start a `SELECT` statement for this database. If an application executes a native SQL statement which begins with `SelectWords` OpenJPA will treat the statement as a `SELECT` statement rather than an `UPDATE` statement.
- `SequenceNameSQL`: Additional phrasing to use with `SequenceSQL`. Defaults to `null`.
- `SequenceSQL`: General structure of the SQL query to use when interrogating the database for sequence names. As there is no standard way to obtain sequence names, it defaults to `null`.
- `SequenceSchemaSQL`: Additional phrasing to use with `SequenceSQL`. Defaults to `null`.
- `SimulateLocking`: Some databases do not support pessimistic locking, which will result in an exception when you attempt a transaction while using the pessimistic lock manager. Setting this property to `true` suppresses the locking of rows in the database, thereby allowing pessimistic transactions even on databases that do not support locking. At the same time, setting this property to `true` means that you do not obtain the semantics of a pessimistic transaction with the database. Defaults to `false`.
- `SmallintTypeName`: The overridden default column type for `java.sql.Types.SMALLINT`. This is used only when the schema is generated by the `mappingtool`.
- `StorageLimitationsFatal`: When true, any data truncation/rounding that is performed by the dictionary in order to store a value in the database will be treated as a fatal error, rather than just issuing a warning.
- `StoreCharsAsNumbers`: Set this property to `false` to store Java `char` fields as `CHAR` values rather than numbers. Defaults to `true`.
- `StoreLargeNumbersAsStrings`: When true, the dictionary prefers to store Java fields of type `BigInteger` and `BigDecimal` as string values in the database. Likewise, the dictionary will instruct the mapping tool to map these Java types to character columns. Because some databases have limitations on the number of digits that can be stored in a numeric column (for example, Oracle can only store 38 digits), this option may be necessary for some applications. Note that this option may prevent OpenJPA from executing meaningful numeric queries against the columns. Defaults to `false`.
- `StringLengthFunction`: Name of the SQL function for getting the length of a string. Use the token `{0}` to represent the argument.
- `StructTypeName`: The overridden default column type for `java.sql.Types.STRUCT`. This is used only when the schema is generated by the `mappingtool`.
- `SubstringFunctionName`: Name of the SQL function for getting the substring of a string.

- 
- `SupportsAlterTableWithAddColumn`: When true, the database supports adding a new column in an ALTER TABLE statement. Defaults to `true`.
  - `SupportsAlterTableWithDropColumn`: When true, the database supports dropping a column in an ALTER TABLE statement. Defaults to `true`.
  - `SupportsAutoAssign`: When true, the database supports auto-assign columns, where the value of column is assigned upon insertion of the row into the database. Defaults to `false`.
  - `SupportsCascadeDeleteAction`: When true, the database supports the CASCADE delete action on foreign keys. Defaults to `true`.
  - `SupportsCascadeUpdateAction`: When true, the database supports the CASCADE update action on foreign keys. Defaults to `true`.
  - `SupportsComments`: When true, comments can be associated with the table in the table creation statement. Defaults to `false`.
  - `SupportsCorrelatedSubselect`: When true, the database supports correlated subselects. Correlated subselects are select statements nested within select statements that refers to a column in the outer select statement. For performance reasons, correlated subselects are generally a last resort. Defaults to `true`.
  - `SupportsDefaultDeleteAction`: When true, the database supports the SET DEFAULT delete action on foreign keys. Defaults to `true`.
  - `SupportsDefaultUpdateAction`: When true, the database supports the SET DEFAULT update action on foreign keys. Defaults to `true`.
  - `SupportsDeferredConstraints`: When true, the database supports deferred constraints. The database supports deferred constraints by checking for constraint violations when the transaction commits, rather than checking for violations immediately after receiving each SQL statement within the transaction. Defaults to `true`.
  - `SupportsDelimitedIdentifiers`: When true, the database supports delimited identifiers. It defaults to `true`.
  - `SupportsForeignKeys`: When true, the database supports foreign keys. Defaults to `true`.
  - `SupportsForeignKeysComposite`: When true, the database supports composite foreign keys. Defaults to `true`.
  - `SupportsGetGeneratedKeys`: When true, OpenJPA will use `java.sql.Statement.getGeneratedKeys` method to obtain values of auto-increment columns. When false, a query specified by `LastGeneratedKeyQuery` will be used for that purpose. If not set, the value will be auto-detected by querying the JDBC driver. Setting the value to true requires that the JDBC driver supports version 3.0 or higher of the JDBC specification and supports the `java.sql.Statement.getGeneratedKeys` method.
  - `SupportsHaving`: When true, the database supports HAVING clauses in selects.
  - `SupportsLockingWithDistinctClause`: When true, the database supports FOR UPDATE select clauses with DISTINCT clauses.
  - `SupportsLockingWithInnerJoin`: When true, the database supports FOR UPDATE select clauses with inner join queries.
  - `SupportsLockingWithMultipleTables`: When true, the database supports FOR UPDATE select clauses that select from multiple tables.
  - `SupportsLockingWithOrderClause`: When true, the database supports FOR UPDATE select clauses with ORDER BY clauses.

- `SupportsLockingWithOuterJoin`: When true, the database supports `FOR UPDATE` select clauses with outer join queries.
- `SupportsLockingWithSelectRange`: When true, the database supports `FOR UPDATE` select clauses with queries that select a range of data using `LIMIT`, `TOP` or the database equivalent. Defaults to `true`.
- `SupportsModOperator`: When true, the database supports the modulus operator (`%`) instead of the `MOD` function. Defaults to `false`.
- `SupportsMultipleNontransactionalResultSets`: When true, a nontransactional connection is capable of having multiple open `ResultSet` instances.
- `SupportsNullDeleteAction`: When true, the database supports the `SET NULL` delete action on foreign keys. Defaults to `true`.
- `SupportsNullTableForGetColumns`: When true, the database supports passing a null parameter to `DatabaseMetaData.getColumns` as an optimization to get information about all the tables. Defaults to `true`.
- `SupportsNullTableForGetImportedKeys`: When true, the database supports passing a null parameter to `DatabaseMetaData.getImportedKeys` as an optimization to get information about all the tables. Defaults to `false`.
- `SupportsNullTableForGetIndexInfo`: When true, the database supports passing a null parameter to `DatabaseMetaData.getIndexInfo` as an optimization to get information about all the tables. Defaults to `false`.
- `SupportsNullTableForGetPrimaryKeys`: When true, the database supports passing a null parameter to `DatabaseMetaData.getPrimaryKeys` as an optimization to get information about all the tables. Defaults to `false`.
- `SupportsNullUpdateAction`: When true, the database supports the `SET NULL` update action on foreign keys. Defaults to `true`.
- `SupportsQueryTimeout`: When true, the JDBC driver supports calls to `java.sql.Statement.setQueryTimeout`.
- `AllowQueryTimeoutOnFindUpdate`: The JPA Specification defines the `javax.persistence.query.timeout`, in milliseconds, as a hint to the provider. The hint is used for Query operations. This property, when set to true, will allow the query timeout hint to apply to `EntityManager` operations. For example, when a 'find' is executed and the resultant entity updated, the query timeout will apply to the SQL update operation. This property defaults to `false`.
- `SupportsRestrictDeleteAction`: When true, the database supports the `RESTRICT` delete action on foreign keys. Defaults to `true`.
- `SupportsRestrictUpdateAction`: When true, the database supports the `RESTRICT` update action on foreign keys. Defaults to `true`.
- `SupportsSchemaForGetColumns`: When false, the database driver does not support using the schema name for schema reflection on column names.
- `SupportsSchemaForGetTables`: If false, then the database driver does not support using the schema name for schema reflection on table names.
- `SupportsSelectEndIndex`: When true, the database can create a select that is limited to the first N results.
- `SupportsSelectForUpdate`: When true, the database supports `SELECT` statements with a pessimistic locking (`FOR UPDATE`) clause. Defaults to `true`.
- `SupportsSelectStartIndex`: When true, the database can create a select that skips the first N results.

- `SupportsSimpleCaseExpression`: When true, the database supports the simple form of CASE expression: `CASE <a> WHEN <b> THEN <c> WHEN <d> THEN <e> ELSE <f> END`. When false, the general form of CASE expression will be used: `CASE WHEN <a> = <b> THEN <c> WHEN <a> = <d> THEN <e> ELSE <f> END`. Defaults to `true`.
- `SupportsSubselect`: When true, the database supports subselects in queries.
- `SupportsTimestampNanos`: When true, the database supports nanoseconds with `TIMESTAMP` columns. Defaults to `true`.
- `SupportsUniqueConstraints`: When true, the database supports unique constraints. Defaults to `true`.
- `SupportsXMLColumn`: When true, the database supports an XML column type. See [Section 7.7.10, “XML Column Mapping” \[324\]](#) for information on using this capability. Defaults to `false`.
- `SystemSchemas`: A comma-separated list of schema names that should be ignored.
- `SystemTables`: A comma-separated list of table names that should be ignored.
- `TableForUpdateClause`: The clause to append to the end of each table alias in queries that obtain pessimistic locks. Defaults to `null`.
- `tableLengthIncludesSchema`: Whether the max length for a table name includes the table's schema. Defaults to `false`.
- `TableTypes`: Comma-separated list of table types to use when looking for tables during schema reflection, as defined in the `java.sql.DatabaseMetaData.getTableInfo` JDBC method. An example is: `"TABLE,VIEW,ALIAS"`. Defaults to `"TABLE"`.
- `TimeTypeName`: The overridden default column type for `java.sql.Types.TIME`. This is used only when the schema is generated by the `mappingtool`.
- `TimestampTypeName`: The overridden default column type for `java.sql.Types.TIMESTAMP`. This is used only when the schema is generated by the `mappingtool`.
- `TinyintTypeName`: The overridden default column type for `java.sql.Types.TINYINT`. This is used only when the schema is generated by the `mappingtool`.
- `ToLowerCaseFunction`: Name of the SQL function for converting a string to lower case. Use the token `{0}` to represent the argument.
- `ToUpperCaseFunction`: SQL function call for converting a string to upper case. Use the token `{0}` to represent the argument.
- `TrailingDelimiter`: The characters to use as the trailing delimiter for a delimited identifier. The default value is a double quote, `( " )`. See [Section 4.4.7, “Delimited Identifiers Support” \[260\]](#) for the default value for some specific databases.
- `TrimBothFunction`: The SQL function call to trim any number of a particular character from both the start and end of a string. Note: some databases do not support specifying the character in which case only spaces or whitespace can be trimmed. Use the token `{1}` when possible to represent the character, and the token `{0}` to represent the string. Defaults to `"TRIM(BOTH {1} FROM {0})"`.
- `TrimLeadingFunction`: The SQL function call to trim any number of a particular character from the start of a string. Note: some databases do not support specifying the character in which case only spaces or whitespace can be trimmed. Use the token `{1}` when possible to represent the character, and the token `{0}` to represent the string. Defaults to `"TRIM(LEADING {1} FROM {0})"`.

- `TrimStringColumns`: When `true`, the resulting `String` from `ResultSet.getString` will be trimmed of trailing white space. Defaults to `false`.
- `TrimTrailingFunction`: The SQL function call to trim any number of a particular character from the end of a string. Note: some databases do not support specifying the character in which case only spaces or whitespace can be trimmed. Use the token `{1}` when possible to represent the character, and the token `{0}` to represent the string. Defaults to `"TRIM(TRAILING {1} FROM {0})"`.
- `UseGetBestRowIdentifierForPrimaryKeys`: When `true`, metadata queries will use `DatabaseMetaData.getBestRowIdentifier` to obtain information about primary keys, rather than `DatabaseMetaData.getPrimaryKeys`.
- `UseGetBytesForBlobs`: When `true`, `ResultSet.getBytes` will be used to obtain blob data rather than `ResultSet.getBinaryStream`.
- `UseGetObjectForBlobs`: When `true`, `ResultSet.getObject` will be used to obtain blob data rather than `ResultSet.getBinaryStream`.
- `UseGetStringForClobs`: When `true`, `ResultSet.getString` will be used to obtain clob data rather than `ResultSet.getCharacterStream`.
- `UseJDBC4SetBinaryStream`: When `true`, an attempt will be made to obtain a JDBC 4.0 version of `PreparedStatement.setBinaryStream`. When `false`, a `setBinaryStream` is used which takes the length of the stream. OpenJPA uses a `-1` for the length since OpenJPA doesn't know the length of the stream. A few JDBC drivers check the length and throw an exception when the length is less than zero. When this property is set to `true`, and an applicable JDK and JDBC 4.0 driver is available, a version of `setBinaryStream` will be used which does not take a length. The default value of this property is `true`.
- `UseNativeSequenceCache`: This property was introduced in the 2.1.2 release to indicate (when set to `false`) that OpenJPA should not use the `CACHE` clause when creating a native sequence; instead the `INCREMENT BY` clause gets its value equal to the `allocationSize` property. In the 2.2.0 release, code was added to allow said functionality by default (see OPENJPA-1376). For forward compatibility, this property still remains, however it has been deprecated and will eventually be removed. Setting this property has no effect and any occurrence of it should be removed.
- `UseSchemaName`: If `false`, then avoid including the schema name in table name references. Defaults to `true`.
- `UseSetBytesForBlobs`: When `true`, `PreparedStatement.setBytes` will be used to set blob data, rather than `PreparedStatement.setBinaryStream`.
- `UseSetStringForClobs`: When `true`, `PreparedStatement.setString` will be used to set clob data, rather than `PreparedStatement.setCharacterStream`.
- `UseWildcardForCount`: When `true`, the JPQL `COUNT` aggregate function will be translated into SQL `COUNT(*)` expression if the SQL query does not involve joins. Defaults to `false`.
- `ValidationSQL`: The SQL used to validate that a connection is still in a valid state. For example, `"SELECT SYSDATE FROM DUAL"` for Oracle.
- `VarbinaryTypeName`: The overridden default column type for `java.sql.Types.VARBINARY`. This is used only when the schema is generated by the `mappingtool`.
- `VarcharTypeName`: The overridden default column type for `java.sql.Types.VARCHAR`. This is used only when the schema is generated by the `mappingtool`.
- `XmlTypeName`: The column type name for XML columns. This property is set automatically in the dictionary and should not need to be overridden. It is used only when the schema is generated using the `mappingtool`. Defaults to `"XML"`.

## 4.4.2. FirebirdDictionary Properties

---

The `firebird` dictionary understands the following additional properties:

- `FirebirdVersion`: The database version OpenJPA connects to. This property affects the SQL statements executed by OpenJPA. Available values are: 15, 20 and 21 - they indicate Firebird versions 1.5, 2.0 and 2.1 respectively. If not set, the value will be auto-detected.
- `IndexedVarcharMaxSizeFB15`: Firebird 1.5 imposes tight limits on index size. In particular, an indexed VARCHAR column size cannot exceed 252. When **schema is created**, OpenJPA will use this property to reduce the size of indexed VARCHAR columns. Defaults to 252 but you might want to decrease this value if multi-column indexes are used. If the Firebird version is 2.0 or later or schema creation is not used, this property does not matter.
- `RangeSyntax`: Firebird 2.0 and later support two ways of handling queries that select a range of data: "FIRST <p> SKIP <q>" and "ROWS <m> TO <n>". Earlier versions support only "FIRST <p> SKIP <q>" syntax. This property determines the syntax to be used. Available values are: "firstskip" and "rows". Defaults to using "ROWS <m> TO <n>" if the Firebird version is 2.0 or later, and "FIRST <p> SKIP <q>" otherwise.

## 4.4.3. MySQLDictionary Properties

---

The `mysql` dictionary also understands the following properties:

- `DriverDeserializesBlobs`: Many older MySQL drivers automatically deserialize BLOBs on calls to `ResultSet.getObject`. The `MySQLDictionary` overrides the standard `DBDictionary.getBlobObject` method to take this into account. Defaults to `true` if driver version is less than 5.0, `false` otherwise. If your driver deserializes automatically, you may want to set this property to `true`.
- `TableType`: The MySQL table type to use when creating tables. Defaults to "innodb".
- `UseClobs`: Some older versions of MySQL do not handle CLOBs correctly. To disable CLOB functionality, set this to `false`. Defaults to `true`.
- `OptimizeMultiTableDeletes`: MySQL as of version 4.0.0 supports multiple tables in DELETE statements. When this option is set, OpenJPA will use that syntax when doing bulk deletes from multiple tables. This can happen when the `deleteTableContents` SchemaTool action is used. (See [Section 4.13, "Schema Tool" \[268\]](#) for more info about `deleteTableContents`.) Defaults to `false`, since the statement may fail if using InnoDB tables and delete constraints.

Starting with Connector/J 3.1.7, MySQL supports a variant of the driver `com.mysql.jdbc.ReplicationDriver` that automatically sends queries to a read/write master, or a failover or round-robin load balanced set of slaves based on the state of read-only status of the connection. See [MySQL Reference](#) for more details.

This replication feature can be used transparently with OpenJPA application by following configuration:

- `openjpa.ConnectionDriverName`: `com.mysql.jdbc.ReplicationDriver`
- `openjpa.ConnectionFactoryProperties`: `autoReconnect=true,roundRobinLoadBalance=true`

OpenJPA will use a read-only connection with replicated database configuration and will automatically switch the connection to a non-readonly mode if the transaction is writing to the database.

## 4.4.4. OracleDictionary Properties

---

The `oracle` dictionary understands the following additional properties:

- `UseTriggersForAutoAssign`: When true, OpenJPA will allow simulation of auto-increment columns by the use of Oracle triggers. OpenJPA will assume that the current sequence value from the sequence specified in the

`AutoAssignSequenceName` parameter will hold the value of the new primary key for rows that have been inserted. For more details on auto-increment support, see [Section 5.4.4, “Autoassign / Identity Strategy Caveats” \[282\]](#).

- `AutoAssignSequenceName`: The global name of the sequence that OpenJPA will assume to hold the value of primary key value for rows that use auto-increment. If left unset, OpenJPA will use a sequence named "`<table name>_<column name>_SEQ`".
- `MaxEmbeddedBlobSize`: Oracle is unable to persist BLOBs using the embedded update method when BLOBs get over a certain size. The size depends on database configuration, e.g. encoding. This property defines the maximum size BLOB to persist with the embedded method. Defaults to 4000 bytes.
- `MaxEmbeddedClobSize`: Oracle is unable to persist CLOBs using the embedded update method when CLOBs get over a certain size. The size depends on database configuration, e.g. encoding. This property defines the maximum size CLOB to persist with the embedded method. Defaults to 4000 characters.
- `SupportsSetClob`: This property was used in releases previous to OpenJPA 2.2.0 to indicate that OpenJPA should attempt to use a Reader-based JDBC 4.0 method to set CLOB or XML data. It allowed XMLType and CLOB values larger than 4000 bytes to be used. For OpenJPA 2.2.0 and later releases, code was added to allow said functionality by default (see OPENJPA-1691). For forward compatibility, this property still remains, however it has been deprecated and will eventually be removed. Setting this property has no effect and any occurrence of it should be removed.
- `UseSetFormOfUseForUnicode`: Prior to Oracle 10i, statements executed against unicode capable columns (the NCHAR, NVARCHAR, NCLOB Oracle types) required special handling to be able to store unicode values. Setting this property to `true` (the default) will cause OpenJPA to attempt to detect when the column is one of these types, and if so, will attempt to correctly configure the statement using the `OraclePreparedStatement.setFormOfUse`. For more details, see the Oracle [JDBC Programming with Unicode](#). Note that this can only work if OpenJPA is able to access the underlying `OraclePreparedStatement` instance, which may not be possible when using some third-party datasources. If OpenJPA detects that this is the case, a warning will be logged.

## 4.4.5. SybaseDictionary Properties

---

The `sybase` dictionary understands the following additional properties:

- `IgnoreNumericTruncation`: If true, Sybase will ignore numeric truncation on SQL operations. Otherwise, if numeric truncation is detected, the operation will fail.

## 4.4.6. DB2 Properties

---

The `db2` dictionary understands the following additional properties:

- `AppendExtendedExceptionText`: If false, OpenJPA will not call back to the database to get extended exception text.
- `SupportsRowNum`: If true, OpenJPA will use ROWNUM facility for range based queries that set an offset and/or limit via `setFirstResult()` and `setMaxResult()` query methods. This property must be set to `true` alongwith `<lietral>SupportsSelectStartIndex</lietral>` and `<lietral>SupportsSelectEndIndex</lietral>`. By default, `SupportsRowNum` is set to `false`. It is appropriate to set `SupportsRowNum` to `true` only when DB2 version being used is 9.7 or later.

## 4.4.7. Delimited Identifiers Support

---

OpenJPA provides support for delimited identifiers as defined in the JPA 2.0 specification. Identifiers can either be automatically delimited or individually manually delimited. To have OpenJPA automatically delimit identifiers, add the `<delimited-identifiers/>` tag to the mapping file as documented in the JPA specification.



You can manually delimit individual identifiers either in the annotations or in the definitions in the mapping file. To delimit an identifier element in an annotation, surround it with double quotes. In a mapping file, add `&quot;` to both the beginning and end of the element.

When delimited identifiers has been specified, OpenJPA will delimit SQL identifiers in the generated SQL statements. It will use database-specific delimiters as defined in the appropriate database dictionary. By default, the leading and trailing delimiters are both double quotes, ( `"` ). Different defaults for other dictionaries provided by OpenJPA are in the following table.

**Table 4.1. Default delimiters for delimited identifiers**

Dictionary	Leading Delimiter	Trailing Delimiter
MySQLDictionary	`	`
AccessDictionary	[	]

Some databases support more than one set of delimiters, often based on configuration. If you need values different than the default values, you can set the `LeadingDelimiter` and the `TrailingDelimiter` dictionary properties.

You can specify whether or not the particular database that you are using supports delimited identifiers by setting the `SupportsDelimitedIdentifiers` dictionary property. If this value is set to `false`, identifiers will not be automatically delimited, even if the `<delimited-identifiers/>` tag is specified in the mapping file.

**Limitation:** The `columnDefinition` elements in identifiers are not automatically delimited by OpenJPA when using the `<delimited-identifiers/>` tag in the mapping file. If you want these to be delimited, you must manually delimit them in the annotation or mapping file definitions.

## 4.5. Setting the Transaction Isolation

OpenJPA typically retains the default transaction isolation level of the JDBC driver. However, you can specify a transaction isolation level to use through the `openjpa.jdbc.TransactionIsolation` configuration property. The following is a list of standard isolation levels. Note that not all databases support all isolation levels.

- `default`: Use the JDBC driver's default isolation level. OpenJPA uses this option if you do not explicitly specify any other.
- `none`: No transaction isolation.
- `read-committed`: Dirty reads are prevented; non-repeatable reads and phantom reads can occur.
- `read-uncommitted`: Dirty reads, non-repeatable reads and phantom reads can occur.
- `repeatable-read`: Dirty reads and non-repeatable reads are prevented; phantom reads can occur.
- `serializable`: Dirty reads, non-repeatable reads, and phantom reads are prevented.

### Example 4.8. Specifying a Transaction Isolation

```
<property name="openjpa.jdbc.TransactionIsolation" value="repeatable-read"/>
```

## 4.6. Setting the SQL Join Syntax

Object queries often involve using SQL joins behind the scenes. You can configure OpenJPA to use either SQL 92-style join syntax, in which joins are placed in the SQL FROM clause, the traditional join syntax, in which join criteria are part of the WHERE clause, or a database-specific join syntax mandated by the `DBDictionary`. OpenJPA only supports outer joins when using SQL 92 syntax or a database-specific syntax with outer join support.

The `openjpa.jdbc.DBDictionary` plugin accepts the `JoinSyntax` property to set the system's default syntax. The available values are:

- `traditional`: Traditional SQL join syntax; outer joins are not supported.
- `database`: The database's native join syntax. Databases that do not have a native syntax will default to one of the other options.
- `sql92`: ANSI SQL92 join syntax. Outer joins are supported. Not all databases support this syntax.

You can change the join syntax at runtime through the OpenJPA fetch configuration API, which is described in [Chapter 9, Runtime Extensions](#) [335].

#### *Example 4.9. Specifying the Join Syntax Default*

```
<property name="openjpa.jdbc.DBDictionary" value="JoinSyntax=sql92"/>
```

#### *Example 4.10. Specifying the Join Syntax at Runtime*

```
import org.apache.openjpa.persistence.jdbc.*;

...

Query q = em.createQuery("select m from Magazine m where m.title = 'JDJ'");
OpenJPAQuery kq = OpenJPAPersistence.cast(q);
JDBCFetchPlan fetch = (JDBCFetchPlan) kq.getFetchPlan();
fetch.setJoinSyntax(JoinSyntax.SQL92);
List results = q.getResultList();
```

## 4.7. Accessing Multiple Databases

Through the properties we've covered thus far, you can configure each `EntityManagerFactory` to access a different database. If your application accesses multiple databases, we recommend that you maintain a separate persistence unit for each one. This will allow you to easily load the appropriate resource for each database at runtime, and to give the correct configuration file to OpenJPA's command-line tools during development.

## 4.8. Configuring the Use of JDBC Connections

In its default configuration, OpenJPA obtains JDBC connections on an as-needed basis. OpenJPA `EntityManager`s do not retain a connection to the database unless they are in a datastore transaction or there are open `Query` results that are using a live JDBC result set. At all other times, including during optimistic transactions, `EntityManager`s request a connection for each query, then immediately release the connection back to the pool.

In some cases, it may be more efficient to retain connections for longer periods of time. You can configure OpenJPA's use of JDBC connections through the `openjpa.ConnectionRetainMode` configuration property. The property accepts the following values:

- `always`: Each `EntityManager` obtains a single connection and uses it until the `EntityManager` closes. Great care should be taken when using this property if the application cannot close the `EntityManager` (i.e. container-managed `EntityManager`s in a JEE Application Server). In this case the connection will remain open for an undefined time and the application may not be able to recover from a terminated connection (for example, if a TCP/IP timeout severs the connection to the database). For this reason the `always` option should not be used with container-managed `EntityManager`s.

- `transaction`: A connection is obtained when each transaction begins (optimistic or datastore), and is released when the transaction completes. Non-transactional connections are obtained on-demand.
- `on-demand`: Connections are obtained only when needed. This option is equivalent to the `transaction` option when datastore transactions are used. For optimistic transactions, though, it means that a connection will be retained only for the duration of the datastore flush and commit process.

You can also specify the connection retain mode of individual `EntityManager`s when you retrieve them from the `EntityManagerFactory`. See [Section 9.2.1, “OpenJPAEntityManagerFactory” \[336\]](#) for details.

The `openjpa.FlushBeforeQueries` configuration property controls another aspect of connection usage: whether to flush transactional changes before executing object queries. This setting only applies to queries that would otherwise have to be executed in-memory because the `IgnoreChanges` property is set to false and the query may involve objects that have been changed in the current transaction. Legal values are:

- `true`: Always flush rather than executing the query in-memory. If the current transaction is optimistic, OpenJPA will begin a non-locking datastore transaction. This is the default.
- `false`: Never flush before a query.
- `with-connection`: Flush only if the `EntityManager` has already established a dedicated connection to the datastore, otherwise execute the query in-memory. This option is useful if you use long-running optimistic transactions and want to ensure that these transactions do not consume database resources until commit. OpenJPA's behavior with this option is dependent on the transaction status and mode, as well as the configured connection retain mode described earlier in this section.

The flush mode can also be varied at runtime using the OpenJPA fetch configuration API, discussed in [Chapter 9, Runtime Extensions \[335\]](#).

The table below describes the behavior of automatic flushing in various situations. In all cases, flushing will only occur if OpenJPA detects that you have made modifications in the current transaction that may affect the query's results.

**Table 4.2. OpenJPA Automatic Flush Behavior**

	<code>FlushBeforeQueries = false</code>	<code>FlushBeforeQueries = true</code>	<code>FlushBeforeQueries = with-connection; ConnectionRetainMode = on-demand</code>	<code>FlushBeforeQueries = with-connection; ConnectionRetainMode = transaction or always</code>
<code>IgnoreChanges = true</code>	no flush	no flush	no flush	no flush
<code>IgnoreChanges = false; no tx active</code>	no flush	no flush	no flush	no flush
<code>IgnoreChanges = false; datastore tx active</code>	no flush	flush	flush	flush
<code>IgnoreChanges = false; optimistic tx active</code>	no flush	flush	no flush unless <code>flush</code> has already been invoked	flush

**Example 4.11. Specifying Connection Usage Defaults**

```
<property name="openjpa.ConnectionRetainMode" value="on-demand"/>
<property name="openjpa.FlushBeforeQueries" value="true"/>
```

**Example 4.12. Specifying Connection Usage at Runtime**

```
import org.apache.openjpa.persistence.*;

// obtaining an em with a certain connection retain mode
Map props = new HashMap();
props.put("openjpa.ConnectionRetainMode", "always");
EntityManager em = emf.createEntityManager(props);
```

## 4.9. Statement Batching

In addition to connection pooling and prepared statement caching, OpenJPA employs statement batching to speed up JDBC updates. Statement batching is enabled by default for any JDBC driver that supports it. When batching is on, OpenJPA automatically orders its SQL statements to maximize the size of each batch. This can result in large performance gains for transactions that modify a lot of data.

You configure statement batching through the system DBDictionary, which is controlled by the `openjpa.jdbc.DBDictionary` configuration property. You can enable the statement batching by setting the `batchLimit` in the value. The batch limit is the maximum number of statements OpenJPA will ever batch together. A value has the following meaning:

- `-1`: Unlimited number of statements for a batch.
- `0`: Disable batch support. This is the default for most dictionaries.
- `any positive number`: Maximum number of statements for a batch.

### Note

By default, the batch support is based on each Dictionary to define the default batch limit. Currently only DB2 and Oracle dictionaries are set the default batch limit to 100. The default batch limit for the rest of the dictionaries is set to zero (disabled).

The example below shows how to enable and disable statement batching via your configuration properties.

**Example 4.13. Enable SQL statement batching**

```
<property name="openjpa.jdbc.DBDictionary" value="db2(batchLimit=25)" />
<property name="openjpa.jdbc.DBDictionary" value="oracle(batchLimit=-1)" />
Or
<property name="openjpa.jdbc.DBDictionary" value="batchLimit=25" />
<property name="openjpa.jdbc.DBDictionary" value="batchLimit=-1" />
```

**Example 4.14. Disable SQL statement batching**

```
<property name="openjpa.jdbc.DBDictionary" value="db2(batchLimit=0)" />
Or
<property name="openjpa.jdbc.DBDictionary" value="batchLimit=0" />
```

By default, `org.apache.openjpa.jdbc.kernel.BatchingConstraintUpdateManager` is the default statement batching implementation. OPENJPA also provides another update manager `org.apache.openjpa.jdbc.kernel.BatchingOperationOrderUpdateManager`

for the statements that required ordering. You can plug-in this update manager through the "openjpa.jdbc.UpdateManager" property. Or you can plug-in your own statement batching implementation by providing the implementation that extends from `AbstractUpdateManager`, `ConstraitUpdateManager` or `OperationOrderUpdateManager`. Add this implementation class as a property in the persistence.xml file. For example, a custom statement batching implementation `mycomp.MyUpdateManager` extends `ConstraitUpdateManager`. You specify this implementation in the persistence.xml file as the following example:

**Example 4.15. Plug-in custom statement batching implementation**

```
<property name="openjpa.jdbc.UpdateManager" value="mycomp.MyUpdateManager" />
```

## 4.10. Large Result Sets

By default, OpenJPA uses standard forward-only JDBC result sets, and completely instantiates the results of database queries on execution. When using a JDBC driver that supports version 2.0 or higher of the JDBC specification, however, you can configure OpenJPA to use scrolling result sets that may not bring all results into memory at once. You can also configure the number of result objects OpenJPA keeps references to, allowing you to traverse potentially enormous amounts of data without exhausting JVM memory.

### Note

You can also configure on-demand loading for individual collection and map fields via large result set proxies. See [Section 5.6.4.2, “Large Result Set Proxies” \[285\]](#).

Use the following properties to configure OpenJPA's handling of result sets:

- **openjpa.FetchBatchSize** : The number of objects to instantiate at once when traversing a result set. This number will be set as the fetch size on JDBC `Statement` objects used to obtain result sets. It also factors in to the number of objects OpenJPA will maintain a hard reference to when traversing a query result.

The fetch size defaults to -1, meaning all results will be instantiated immediately on query execution. A value of 0 means to use the JDBC driver's default batch size. Thus to enable large result set handling, you must set this property to 0 or to a positive number.

- **openjpa.jdbc.ResultSetType** : The type of result set to use when executing database queries. This property accepts the following values, each of which corresponds exactly to the same-named `java.sql.ResultSet` constant:
  - `forward-only`: This is the default.
  - `scroll-sensitive`
  - `scroll-insensitive`

Different JDBC drivers treat the different result set types differently. Not all drivers support all types.

- **openjpa.jdbc.FetchDirection**: The expected order in which you will access the query results. This property affects the type of data structure OpenJPA will use to hold the results, and is also given to the JDBC driver in case it can optimize for certain access patterns. This property accepts the following values, each of which corresponds exactly to the same-named `java.sql.ResultSet` `FETCH` constant:
  - `forward`: This is the default.
  - `reverse`

- unknown

Not all drivers support all fetch directions.

- `openjpa.jdbc.LRSSize`: The strategy OpenJPA will use to determine the size of result sets. This property is **only** used if you change the fetch batch size from its default of -1, so that OpenJPA begins to use on-demand result loading. Available values are:
  - `query`: This is the default. The first time you ask for the size of a query result, OpenJPA will perform a `SELECT COUNT(*)` query to determine the number of expected results. Note that depending on transaction status and settings, this can mean that the reported size is slightly different than the actual number of results available.
  - `last`: If you have chosen a scrollable result set type, this setting will use the `ResultSet.last` method to move to the last element in the result set and get its index. Unfortunately, some JDBC drivers will bring all results into memory in order to access the last one. Note that if you do not choose a scrollable result set type, then this will behave exactly like `unknown`. The default result set type is `forward-only`, so you must change the result set type in order for this property to have an effect.
  - `unknown`: Under this setting OpenJPA will return `Integer.MAX_VALUE` as the size for any query result that uses on-demand loading.

#### Example 4.16. Specifying Result Set Defaults

```
<property name="openjpa.FetchBatchSize" value="20"/>
<property name="openjpa.jdbc.ResultSetType" value="scroll-insensitive"/>
<property name="openjpa.jdbc.FetchDirection" value="forward"/>
<property name="openjpa.jdbc.LRSSize" value="last"/>
```

Many **OpenJPA runtime components** also have methods to configure these properties on a case-by-case basis through their fetch configuration. See [Chapter 9, Runtime Extensions \[335\]](#).

#### Example 4.17. Specifying Result Set Behavior at Runtime

```
import java.sql.*;
import org.apache.openjpa.persistence.jdbc.*;

...

Query q = em.createQuery("select m from Magazine m where m.title = 'JDJ'");
OpenJPAQuery kq = OpenJPAPersistence.cast(q);
JDBCFetchPlan fetch = (JDBCFetchPlan) kq.getFetchPlan();
fetch.setFetchBatchSize(20);
fetch.setResultSetType(ResultSetType.SCROLL_INSENSITIVE);
fetch.setFetchDirection(FetchDirection.FORWARD);
fetch.setLRSSizeAlgorithm(LRSSizeAlgorithm.LAST);
List results = q.getResultList();
```

## 4.11. Default Schema

It is common to duplicate a database model in multiple schemas. You may have one schema for development and another for production, or different database users may access different schemas. OpenJPA facilitates these patterns with the `openjpa.jdbc.Schema` configuration property. This property establishes a default schema for any unqualified table names, allowing you to leave schema names out of your mapping definitions.

The Schema property also establishes the default schema for new tables created through OpenJPA tools, such as the mapping tool covered in [Section 7.1, “Forward Mapping” \[304\]](#).

If the entities are mapped to the same table name but with different schema name within one `PersistenceUnit` intentionally, and the strategy of `GeneratedType.AUTO` is used to generate the ID for each entity, a schema name for each entity must be explicitly declared either through the annotation or the mapping.xml file. Otherwise, the mapping tool only creates the tables for those entities with the schema names under each schema. In addition, there will be only one `OPENJPA_SEQUENCE_TABLE` created for all the entities within the `PersistenceUnit` if the entities are not identified with the schema name. Read [Section 9.6, “Generators” \[344\]](#) in the Reference Guide.

## 4.12. Schema Reflection

OpenJPA needs information about your database schema for two reasons. First, it can use schema information at runtime to validate that your schema is compatible with your persistent class definitions. Second, OpenJPA requires schema information during development so that it can manipulate the schema to match your object model. OpenJPA uses the `SchemaFactory` interface to provide runtime mapping information, and the `SchemaTool` for development-time data. Each is presented below.

### 4.12.1. Schemas List

By default, schema reflection acts on all the schemas your JDBC driver can "see". You can limit the schemas and tables OpenJPA acts on with the `openjpa.jdbc.Schemas` configuration property. This property accepts a comma-separated list of schemas and tables. To list a schema, list its name. To list a table, list its full name in the form `<schema-name>.<table-name>`. If a table does not have a schema or you do not know its schema, list its name as `.<table-name>` (notice the preceding '.'). For example, to list the `BUSOBSJS` schema, the `ADDRESS` table in the `GENERAL` schema, and the `SYSTEM_INFO` table, regardless of what schema it is in, use the string:

```
BUSOBSJS,GENERAL.ADDRESS, .SYSTEM_INFO
```

#### Note

Some databases are case-sensitive with respect to schema and table names. Oracle, for example, requires names in all upper case.

### 4.12.2. Schema Factory

OpenJPA relies on the `openjpa.jdbc.SchemaFactory` interface for runtime schema information. You can control the schema factory OpenJPA uses through the `openjpa.jdbc.SchemaFactory` property. There are several built-in options to choose from:

- `dynamic`: This is the default setting. It is an alias for the `org.apache.openjpa.jdbc.schema.DynamicSchemaFactory`. The `DynamicSchemaFactory` is the most performant schema factory, because it does not validate mapping information against the database. Instead, it assumes all object-relational mapping information is correct, and dynamically builds an in-memory representation of the schema from your mapping metadata. When using this factory, it is important that your mapping metadata correctly represent your database's foreign key constraints so that OpenJPA can order its SQL statements to meet them.
- `native`: This is an alias for the `org.apache.openjpa.jdbc.schema.LazySchemaFactory`. As persistent classes are loaded by the application, OpenJPA reads their metadata and object-relational mapping information. This factory uses the `java.sql.DatabaseMetaData` interface to reflect on the schema and ensure that it is consistent with the



mapping data being read. Use this factory if you want up-front validation that your mapping metadata is consistent with the database during development. This factory accepts the following important properties:

- `ForeignKeys`: Set to `true` to automatically read foreign key information during schema validation.
- `table`: This is an alias for the `org.apache.openjpa.jdbc.schema.TableSchemaFactory`. This schema factory stores schema information as an XML document in a database table it creates for this purpose. If your JDBC driver doesn't support the `java.sql.DatabaseMetaData` standard interface, but you still want some schema validation to occur at runtime, you might use this factory. It is not recommended for most users, though, because it is easy for the stored XML schema definition to get out-of-synch with the actual database. This factory accepts the following properties:
  - `Table`: The name of the table to create to store schema information. Defaults to `OPENJPA_SCHEMA`.
  - `PrimaryKeyColumn`: The name of the table's numeric primary key column. Defaults to `ID`.
  - `SchemaColumn`: The name of the table's string column for holding the schema definition as an XML string. Defaults to `SCHEMA_DEF`.
- `file`: This is an alias for the `org.apache.openjpa.jdbc.schema.FileSchemaFactory`. This factory is a lot like the `TableSchemaFactory`, and has the same advantages and disadvantages. Instead of storing its XML schema definition in a database table, though, it stores it in a file. This factory accepts the following properties:
  - `File`: The resource name of the XML schema file. By default, the factory looks for a resource called `package.schema`, located in any top-level directory of the `CLASSPATH` or in the top level of any jar in your `CLASSPATH`.

You can switch freely between schema factories at any time. The XML file format used by some factories is detailed in [Section 4.14, “XML Schema Format” \[271\]](#). As with any OpenJPA plugin, you can also implement your own schema factory if you have needs not met by the existing options.

## 4.13. Schema Tool

Most users will only access the schema tool indirectly, through the interfaces provided by other tools. You may find, however, that the schema tool is a powerful utility in its own right. The schema tool has two functions:

1. To reflect on the current database schema, optionally translating it to an XML representation for further manipulation.
2. To take in an XML schema definition, calculate the differences between the XML and the existing database schema, and apply the necessary changes to make the database match the XML.

The **XML format** used by the schema tool abstracts away the differences between SQL dialects used by different database vendors. The tool also automatically adapts its SQL to meet foreign key dependencies. Thus the schema tool is useful as a general way to manipulate schemas.

You can invoke the schema tool through its Java class, `org.apache.openjpa.jdbc.schema.SchemaTool`. In addition to the universal flags of the **configuration framework**, the schema tool accepts the following command line arguments:

- `-ignoreErrors/-i <true/t | false/f>`: If `false`, an exception will be thrown if the tool encounters any database errors. Defaults to `false`.
- `-file/-f <stdout | output file>`: Use this option to write a SQL script for the planned schema modifications, rather than committing them to the database. When used in conjunction with the `export` or `reflect` actions, the named file will be used to write the exported schema XML. If the file names a resource in the `CLASSPATH`, data will be written to that resource. Use `stdout` to write to standard output. Defaults to `stdout`.
- `-openjpaTables/-ot <true/t | false/f>`: When reflecting on the schema, whether to reflect on tables and sequences whose names start with `OPENJPA_`. Certain OpenJPA components may use such tables - for example,



the table schema factory option covered in [Section 4.12.2, “Schema Factory” \[267\]](#). When using other actions, `openjpaTables` controls whether these tables can be dropped. Defaults to `false`.

- `-dropTables/-dt <true/t | false/f>`: Set this option to `true` to drop tables that appear to be unused during `retain` and `refresh` actions. Defaults to `true`.
- `-dropSequences/-dsq <true/t | false/f>`: Set this option to `true` to drop sequences that appear to be unused during `retain` and `refresh` actions. Defaults to `true`.
- `-sequences/-sq <true/t | false/f>`: Whether to manipulate sequences. Defaults to `true`.
- `-indexes/-ix <true/t | false/f>`: Whether to manipulate indexes on existing tables. Defaults to `true`.
- `-primaryKeys/-pk <true/t | false/f>`: Whether to manipulate primary keys on existing tables. Defaults to `true`.
- `-foreignKeys/-fk <true/t | false/f>`: Whether to manipulate foreign keys on existing tables. Defaults to `true`.
- `-record/-r <true/t | false/f>`: Use `false` to prevent writing the schema changes made by the tool to the current **schema factory**. Defaults to `true`.
- `-schemas/-s <schema list>`: A list of schema and table names that OpenJPA should access during this run of the schema tool. This is equivalent to setting the `openjpa.jdbc.Schemas` property for a single run.

The schema tool also accepts an `-action` or `-a` flag. Multiple actions can be composed in a comma-separated list. The available actions are:

- `add`: This is the default action if you do not specify one. It brings the schema up-to-date with the given XML document by adding tables, columns, indexes, etc. This action never drops any schema components.
- `retain`: Keep all schema components in the given XML definition, but drop the rest from the database. This action never adds any schema components.
- `drop`: Drop all schema components in the schema XML. Tables will only be dropped if they would have 0 columns after dropping all columns listed in the XML.
- `refresh`: Equivalent to `retain`, then `add`.
- `build`: Generate SQL to build a schema matching the one in the given XML file. Unlike `add`, this option does not take into account the fact that part of the schema defined in the XML file might already exist in the database. Therefore, this action is typically used in conjunction with the `-file` flag to write a SQL script. This script can later be used to recreate the schema in the XML.
- `reflect`: Generate an XML representation of the current database schema.
- `createDB`: Generate SQL to re-create the current database. This action is typically used in conjunction with the `-file` flag to write a SQL script that can be used to recreate the current schema on a fresh database.
- `dropDB`: Generate SQL to drop the current database. Like `createDB`, this action can be used with the `-file` flag to script a database drop rather than perform it.
- `import`: Import the given XML schema definition into the current schema factory. Does nothing if the factory does not store a record of the schema.
- `export`: Export the current schema factory's stored schema definition to XML. May produce an empty file if the factory does not store a record of the schema.
- `deleteTableContents`: Execute SQL to delete all rows from all tables that OpenJPA knows about.

## Note

The schema tool manipulates tables, columns, indexes, constraints, and sequences. It cannot create or drop the database schema objects in which the tables reside, however. If your XML documents refer to named database schemas, those schemas must exist.

We present some examples of schema tool usage below.

### *Example 4.18. Schema Creation*

Add the necessary schema components to the database to match the given XML document, but don't drop any data:

```
java org.apache.openjpa.jdbc.schema.SchemaTool targetSchema.xml
```

### *Example 4.19. SQL Scripting*

Repeat the same action as the first example, but this time don't change the database. Instead, write any planned changes to a SQL script:

```
java org.apache.openjpa.jdbc.schema.SchemaTool -f script.sql targetSchema.xml
```

Write a SQL script that will re-create the current database:

```
java org.apache.openjpa.jdbc.schema.SchemaTool -a createDB -f script.sql
```

### *Example 4.20. Table Cleanup*

Refresh the schema and delete all contents of all tables that OpenJPA knows about:

```
java org.apache.openjpa.jdbc.schema.SchemaTool -a refresh,deleteTableContents
```

### *Example 4.21. Schema Drop*

Drop the current database:

```
java org.apache.openjpa.jdbc.schema.SchemaTool -a dropDB
```

### *Example 4.22. Schema Reflection*

Write an XML representation of the current schema to file `schema.xml` .

```
java org.apache.openjpa.jdbc.schema.SchemaTool -a reflect -f schema.xml
```

## 4.14. XML Schema Format

The **schema tool** and **schema factories** all use the same XML format to represent database schema. The Document Type Definition (DTD) for schema information is presented below, followed by examples of schema definitions in XML.

```
<!ELEMENT schemas (schema)+>
<!ELEMENT schema (table|sequence)+>
<!ATTLIST schema name CDATA #IMPLIED>

<!ELEMENT sequence EMPTY>
<!ATTLIST sequence name CDATA #REQUIRED>
<!ATTLIST sequence initial-value CDATA #IMPLIED>
<!ATTLIST sequence increment CDATA #IMPLIED>
<!ATTLIST sequence allocate CDATA #IMPLIED>

<!ELEMENT table (column|index|pk|fk|unique)+>
<!ATTLIST table name CDATA #REQUIRED>

<!ELEMENT column EMPTY>
<!ATTLIST column name CDATA #REQUIRED>
<!ATTLIST column type (array | bigint | binary | bit | blob | char | clob
| date | decimal | distinct | double | float | integer | java_object
| longvarbinary | longvarchar | null | numeric | other | real | ref
| smallint | struct | time | timestamp | tinyint | varbinary | varchar)
#REQUIRED>
<!ATTLIST column not-null (true|false) "false">
<!ATTLIST column auto-assign (true|false) "false">
<!ATTLIST column default CDATA #IMPLIED>
<!ATTLIST column size CDATA #IMPLIED>
<!ATTLIST column decimal-digits CDATA #IMPLIED>

<!-- the type-name attribute can be used when you want OpenJPA to -->
<!-- use a particular SQL type declaration when creating the -->
<!-- column. It is up to you to ensure that this type is -->
<!-- compatible with the JDBC type used in the type attribute. -->
<!ATTLIST column type-name CDATA #IMPLIED>

<!-- the 'column' attribute of indexes, pks, and fks can be used -->
<!-- when the element has only one column (or for foreign keys, -->
<!-- only one local column); in these cases the on/join child -->
<!-- elements can be omitted -->
<!ELEMENT index (on)*>
<!ATTLIST index name CDATA #REQUIRED>
<!ATTLIST index column CDATA #IMPLIED>
<!ATTLIST index unique (true|false) "false">

<!-- the 'logical' attribute of pks should be set to 'true' if -->
<!-- the primary key does not actually exist in the database, -->
<!-- but the given column should be used as a primary key for -->
<!-- O-R purposes -->
<!ELEMENT pk (on)*>
<!ATTLIST pk name CDATA #IMPLIED>
<!ATTLIST pk column CDATA #IMPLIED>
<!ATTLIST pk logical (true|false) "false">

<!ELEMENT on EMPTY>
<!ATTLIST on column CDATA #REQUIRED>

<!-- fks with a delete-action of 'none' are similar to logical -->
<!-- pks; they do not actually exist in the database, but -->
<!-- represent a logical relation between tables (or their -->
<!-- corresponding Java classes) -->
<!ELEMENT fk (join)*>
```

```

<!ATTLIST fk name CDATA #IMPLIED>
<!ATTLIST fk deferred (true|false) "false">
<!ATTLIST fk to-table CDATA #REQUIRED>
<!ATTLIST fk column CDATA #IMPLIED>
<!ATTLIST fk delete-action (cascade|default|exception|none|null) "none">

<!ELEMENT join EMPTY>
<!ATTLIST join column CDATA #REQUIRED>
<!ATTLIST join to-column CDATA #REQUIRED>
<!ATTLIST join value CDATA #IMPLIED>

<!-- unique constraint -->
<!ELEMENT unique (on)*>
<!ATTLIST unique name CDATA #IMPLIED>
<!ATTLIST unique column CDATA #IMPLIED>
<!ATTLIST unique deferred (true|false) "false">

```

### Example 4.23. Basic Schema

A very basic schema definition.

```

<schemas>
  <schema>
    <sequence name="S_ARTS" />
    <table name="ARTICLE">
      <column name="TITLE" type="varchar" size="255" not-null="true" />
      <column name="AUTHOR_FNAME" type="varchar" size="28">
      <column name="AUTHOR_LNAME" type="varchar" size="28">
      <column name="CONTENT" type="clob">
    </table>
    <table name="AUTHOR">
      <column name="FIRST_NAME" type="varchar" size="28" not-null="true">
      <column name="LAST_NAME" type="varchar" size="28" not-null="true">
    </table>
  </schema>
</schemas>

```

### Example 4.24. Full Schema

Expansion of the above schema with primary keys, constraints, and indexes, some of which span multiple columns.

```

<schemas>
  <schema>
    <sequence name="S_ARTS" />
    <table name="ARTICLE">
      <column name="TITLE" type="varchar" size="255" not-null="true" />
      <column name="AUTHOR_FNAME" type="varchar" size="28">
      <column name="AUTHOR_LNAME" type="varchar" size="28">
      <column name="CONTENT" type="clob">
      <pk column="TITLE" />
      <fk to-table="AUTHOR" delete-action="exception">
        <join column="AUTHOR_FNAME" to-column="FIRST_NAME" />
        <join column="AUTHOR_LNAME" to-column="LAST_NAME" />
      </fk>
      <index name="ARTICLE_AUTHOR">
        <on column="AUTHOR_FNAME" />
        <on column="AUTHOR_LNAME" />
      </index>
    </table>
    <table name="AUTHOR">
      <column name="FIRST_NAME" type="varchar" size="28" not-null="true">
      <column name="LAST_NAME" type="varchar" size="28" not-null="true">
      <pk>
        <on column="FIRST_NAME" />
        <on column="LAST_NAME" />
      </pk>
    </table>
  </schema>
</schemas>

```

```
</table>  
</schema>  
</schemas>
```

---

# Chapter 5. Persistent Classes

Persistent class basics are covered in [Chapter 4, \*Entity\*](#) [17] of the JPA Overview. This chapter details the persistent class features OpenJPA offers beyond the core JPA specification.

## 5.1. Persistent Class List

---

Unlike many ORM products, OpenJPA does not need to know about all of your persistent classes at startup. OpenJPA discovers new persistent classes automatically as they are loaded into the JVM; in fact you can introduce new persistent classes into running applications under OpenJPA. However, there are certain situations in which providing OpenJPA with a persistent class list is helpful:

- OpenJPA must be able to match entity names in JPQL queries to persistent classes. OpenJPA automatically knows the entity names of any persistent classes already loaded into the JVM. To match entity names to classes that have not been loaded, however, you must supply a persistent class list.
- When OpenJPA manipulates classes in a persistent inheritance hierarchy, OpenJPA must be aware of all the classes in the hierarchy. If some of the classes have not been loaded into the JVM yet, OpenJPA may not know about them, and queries may return incorrect results.
- If you configure OpenJPA to create the needed database schema on startup (see [Section 7.1.3, “Runtime Forward Mapping”](#) [306]), OpenJPA must know all of your persistent classes up-front.

When any of these conditions are a factor in your JPA application, use the `class`, `mapping-file`, and `jar-file` elements of JPA's standard XML format to list your persistent classes. See [Section 6.1, “persistence.xml”](#) [69] for details.

Alternately, you can tell OpenJPA to search through your classpath for persistent types. This is described in more detail in [Section 6.1, “Metadata Factory”](#) [297].

### Note

Listing persistent classes (or their metadata or jar files) is an all-or-nothing endeavor. If your persistent class list is non-empty, OpenJPA will assume that any unlisted class is not persistent.

## 5.2. Enhancement

---

In order to provide optimal runtime performance, flexible lazy loading, and efficient, immediate dirty tracking, OpenJPA can use an *enhancer*. An enhancer is a tool that automatically adds code to your persistent classes after you have written them. The enhancer post-processes the bytecode generated by your Java compiler, adding the necessary fields and methods to implement the required persistence features. This bytecode modification perfectly preserves the line numbers in stack traces and is compatible with Java debuggers. In fact, the only change to debugging is that the persistent setter and getter methods of entity classes using property access will be prefixed with `pc` in stack traces and step-throughs. For example, if your entity has a `getId` method for persistent property `id`, and that method throws an exception, the stack trace will report the exception from method `pcgetId`. The line numbers, however, will correctly correspond to the `getId` method in your source file.

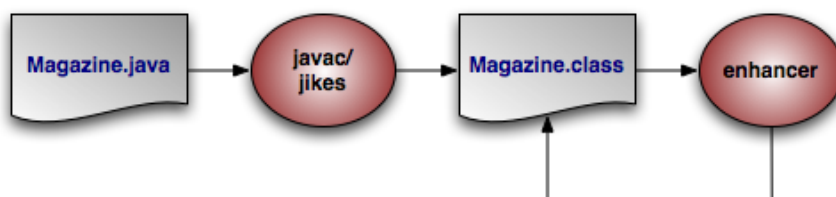

The diagram above illustrates the compilation of a persistent class.

You can add the OpenJPA enhancer to your build process, or use Java 1.5's instrumentation features to transparently enhance persistent classes when they are loaded into the JVM. The following sections describe each option.

## 5.2.1. Enhancing at Build Time

The enhancer can be invoked at build time via its Java class, `org.apache.openjpa.enhance.PCEnhancer`.

### Note

You can also enhance via Ant; see [Section 14.1.2, “Enhancer Ant Task” \[379\]](#).

#### Example 5.1. Using the OpenJPA Enhancer

```
java org.apache.openjpa.enhance.PCEnhancer Magazine.java
```

The enhancer accepts the standard set of command-line arguments defined by the configuration framework (see [Section 2.3, “Command Line Configuration” \[208\]](#)), along with the following flags:

- `-directory/-d <output directory>`: Path to the output directory. If the directory does not match the enhanced class' package, the package structure will be created beneath the directory. By default, the enhancer overwrites the original `.class` file.
- `-enforcePropertyRestrictions/-epr <true/t | false/f>`: Whether to throw an exception when it appears that a property access entity is not obeying the restrictions placed on property access. Defaults to `false`.
- `-addDefaultConstructor/-adc <true/t | false/f>`: The spec requires that all persistent classes define a no-arg constructor. This flag tells the enhancer whether to add a protected no-arg constructor to any persistent classes that don't already have one. Defaults to `true`.
- `-tmpClassLoader/-tcl <true/t | false/f>`: Whether to load persistent classes with a temporary class loader. This allows other code to then load the enhanced version of the class within the same JVM. Defaults to `true`. Try setting this flag to `false` as a debugging step if you run into class loading problems when running the enhancer.

Each additional argument to the enhancer must be one of the following:

- The full name of a class.
- The `.java` file for a class.
- The `.class` file of a class.

If you do not supply any arguments to the enhancer, it will run on the classes in your persistent class list (see [Section 5.1, “Persistent Class List” \[274\]](#)). You must, however, supply the classpath you wish the enhancer to run with. This classpath must include, at minimum, the `openjpa` jar(s), `persistence.xml` and the target classes.

You can run the enhancer over classes that have already been enhanced, in which case it will not further modify the class. You can also run it over classes that are not persistence-capable, in which case it will treat the class as persistence-aware. Persistence-aware classes can directly manipulate the persistent fields of persistence-capable classes.

Note that the enhancement process for subclasses introduces dependencies on the persistent parent class being enhanced. This is normally not problematic; however, when running the enhancer multiple times over a subclass whose parent class is not yet enhanced, class loading errors can occur. In the event of a class load error, simply re-compile and re-enhance the offending classes.

## 5.2.2. Enhancing JPA Entities on Deployment

The Java EE specification includes hooks to automatically enhance JPA entities when they are deployed into a container. Thus, if you are using a Java EE-compliant application server, OpenJPA will enhance your entities automatically at runtime. Note that if you prefer build-time enhancement, OpenJPA's runtime enhancer will correctly recognize and skip pre-enhanced classes.

If your application server does not support the Java EE enhancement hooks, consider using the build-time enhancement described above, or the more general runtime enhancement described in the next section.

## 5.2.3. Enhancing at Runtime

OpenJPA includes a *Java agent* for automatically enhancing persistent classes as they are loaded into the JVM. Java agents are classes that are invoked prior to your application's `main` method. OpenJPA's agent uses JVM hooks to intercept all class loading to enhance classes that have persistence metadata before the JVM loads them.

Searching for metadata for every class loaded by the JVM can slow application initialization. One way to speed things up is to take advantage of the optional persistent class list described in [Section 5.1, “Persistent Class List” \[274\]](#). If you declare a persistent class list, OpenJPA will only search for metadata for classes in that list.

To employ the OpenJPA agent, invoke `java` with the `-javaagent` set to the path to your OpenJPA jar file.

### *Example 5.2. Using the OpenJPA Agent for Runtime Enhancement*

```
java -javaagent:/home/dev/openjpa/lib/openjpa.jar com.xyz.Main
```

You can pass settings to the agent using OpenJPA's plugin syntax (see [Section 2.4, “Plugin Configuration” \[210\]](#)). The agent accepts the long form of any of the standard configuration options ([Section 2.3, “Command Line Configuration” \[208\]](#)). It also accepts the following options, the first three of which correspond exactly to the same-named options of the enhancer tool described in [Section 5.2.1, “Enhancing at Build Time” \[275\]](#):

- `addDefaultConstructor`
- `enforcePropertyRestrictions`
- `scanDevPath`: Boolean indicating whether to scan the classpath for persistent types if none have been configured. If you do not specify a persistent types list and do not set this option to `true`, OpenJPA will check whether each class loaded into the JVM is persistent, and enhance it accordingly. This may slow down class load times significantly.
- `classLoadEnhancement`: Boolean controlling whether OpenJPA load-time class enhancement should be available in this JVM execution. Default: `true`
- `runtimeRedefinition`: Boolean controlling whether OpenJPA class redefinition should be available in this JVM execution. Default: `true`

### *Example 5.3. Passing Options to the OpenJPA Agent*

```
java -javaagent:/home/dev/openjpa/lib/openjpa.jar=addDefaultConstructor=false com.xyz.Main
```

## 5.2.4. Enhancing Dynamically at Runtime

If a `javaagent` is not provided via the command line and OpenJPA is running on the Oracle 1.6 SDK or IBM 1.6 JDK (SR8+), OpenJPA will attempt to dynamically load the Enhancer that was mentioned in the previous section. This support is provided



as an ease of use feature and it is not recommended for use in a production system. Using this method of enhancement has the following caveats:

- The dynamic runtime enhancer is plugged into the JVM during creation of the EntityManagerFactory. Any Entity classes that are loaded before the EntityManagerFactory is created will not be enhanced.
- The command line javaagent settings are not configurable when using this method of enhancement.
- Just as with the Javaagent approach, if you declare a persistent class list, then OpenJPA will only search for metadata and try to enhance the listed classes.

When the dynamic enhancer is loaded, the following informational message is logged:

```
[java] jpa.enhancement INFO [main] openjpa.Runtime - OpenJPA dynamically loaded the class enhancer. Any classes that were not
```

Setting the property `openjpa.DynamicEnhancementAgent` to `false` will disable this function.

## 5.2.5. Omitting the OpenJPA enhancer

OpenJPA does not require that the enhancer be run. If you do not run the enhancer, OpenJPA will fall back to one of several possible alternatives for state tracking, depending on the execution environment.

- *Deploy-time enhancement*: if you are running your application inside a Java EE container, or another environment that supports the JPA container contract, then OpenJPA will automatically perform class transformation at deploy time.
- *Java 6 class retransformation*: if you are running your application in a Java 6 environment, OpenJPA will attempt to dynamically register a `ClassTransformer` that will redefine your persistent classes on the fly to track access to persistent data. Additionally, OpenJPA will create a subclass for each of your persistent classes. When you execute a query or traverse a relation, OpenJPA will return an instance of the subclass. This means that the `instanceof` operator will work as expected, but `o.getClass()` will return the subclass instead of the class that you wrote.

You do not need to do anything at all to get this behavior. OpenJPA will automatically detect whether or not the execution environment is capable of Java 6 class retransformation.

- *Java 5 class redefinition*: if you are running your application in a Java 5 environment, and you specify the OpenJPA javaagent, OpenJPA will use Java 5 class redefinition to redefine any persistent classes that are not enhanced by the OpenJPA javaagent. Aside from the requirement that you specify a javaagent on the command line, this behavior is exactly the same as the Java 6 class retransformation behavior. Of course, since the OpenJPA javaagent performs enhancement by default, this will only be available if you set the `classLoadEnhancement` javaagent flag to `false`, or on any classes that are skipped by the OpenJPA runtime enhancement process for some reason.
- *Runtime Unenhanced Classes*: AKA state comparison and subclassing. If you are running in a Java 5 environment without a javaagent, or in a Java 6 environment that does not support class retransformation, OpenJPA will still create subclasses as outlined above. However, in some cases, OpenJPA may not be able to receive notifications when you read or write persistent data.

### Note

Runtime Unenhanced Classes has some known limitations which are discussed below and documented in JIRA issue tracker on the OpenJPA website. As a result this option is disabled by default. Support for this method of automatic enhancement may be enabled via the [Section 2.5.65, “openjpa.RuntimeUnenhancedClasses” \[227\]](#) option.

To enable Runtime Unenhanced Classes for a specific persistence unit, add the following property to `persistence.xml`:

```

<properties>
  . . .
  <property name="openjpa.RuntimeUnenhancedClasses" value="supported" />
  . . .
</properties>

```

If you are using *property access* for your persistent data, then OpenJPA will be able to track all accesses for instances that you load from the database, but not for instances that you create. This is because OpenJPA will create new instances of its dynamically-generated subclass when it loads data from the database. The dynamically-generated subclass has code in the setters and getters that notify OpenJPA about persistent data access. This means that new instances that you create will be subject to state-comparison checks (see discussion below) to compute which fields to write to the database, and that OpenJPA will ignore requests to evict persistent data from such instances. In practice, this is not a particularly bad limitation, since OpenJPA already knows that it must insert all field values for new instances. So, this is only really an issue if you flush changes to the database while inserting new records; after such a flush, OpenJPA will need to hold potentially-unneeded hard references to the new-flushed instances.

If you are using *field access* for your persistent data, then OpenJPA will not be able to track accesses for any instances, including ones that you load from the database. So, OpenJPA will perform state-comparison checks to determine which fields are dirty. These state comparison checks are costly in two ways. First, there is a performance penalty at flush / commit time, since OpenJPA must walk through every field of every instance to determine which fields of which records are dirty. Second, there is a memory penalty, since OpenJPA must hold hard references to all instances that were loaded at any time in a given transaction, and since OpenJPA must keep a copy of all the initial values of the loaded data for later comparison. Additionally, OpenJPA will ignore requests to evict persistent state for these types of instances. Finally, the default lazy loading configuration will be ignored for single-valued fields (one-to-one, many-to-one, and any other non-collection or non-map field that has a lazy loading configuration). If you use fetch groups or programmatically configure your fetch plan, OpenJPA will obey these directives, but will be unable to lazily load any data that you exclude from loading. As a result of these limitations, it is not recommended that you use field access if you are not either running the enhancer or using OpenJPA with a javaagent or in a Java 6 environment.

## 5.3. Managed Interfaces

OpenJPA's managed interface feature allows you to define your object model entirely in terms of interfaces, instead of concrete classes. To use this feature, you must annotate your managed interfaces with the `ManagedInterface` annotation, and use the `OpenJPAEntityManager.createInstance(Class)` method to create new records. Note that `createInstance()` returns unmanaged instances; you must pass them to `EntityManager.persist()` to store them in the database.

```

@ManagedInterface
public interface PersonIface {
    @Id @GeneratedValue
    int getId();
    void setId(int id);

    // implicitly persistent per JPA property rules
    String getName();
    void setName(String name);
}

```

```

OpenJPAEntityManager em = ...;
PersonIface person = em.createInstance(PersonIface.class);
person.setName("Homer Simpson");
em.getTransaction().begin();

```

```
em.persist(person);
em.getTransaction().commit();
```

## 5.4. Object Identity

OpenJPA makes several enhancements to JPA's standard entity identity.

### 5.4.1. Datastore Identity

The JPA specification requires you to declare one or more identity fields in your persistent classes. OpenJPA fully supports this form of object identity, called *application* identity. OpenJPA, however, also supports *datastore* identity. In datastore identity, you do not declare any primary key fields. OpenJPA manages the identity of your persistent objects for you through a surrogate key in the database.

You can control how your JPA datastore identity value is generated through OpenJPA's `org.apache.openjpa.persistence.DataStoreId` class annotation. This annotation has `strategy` and `generator` properties that mirror the same-named properties on the standard `javax.persistence.GeneratedValue` annotation described in [Section 5.2.3, “Id” \[34\]](#) of the JPA Overview.

To retrieve the identity value of a datastore identity entity, use the `OpenJPAEntityManager.getObjectId(Object entity)` method. See [Section 9.2.2, “OpenJPAEntityManager” \[336\]](#) for more information on the `OpenJPAEntityManager`.

#### *Example 5.4. JPA Datastore Identity Metadata*

```
import org.apache.openjpa.persistence.*;

@Entity
@DataStoreId
public class LineItem {

    ... no @Id fields declared ...

}
```

Internally, OpenJPA uses the public `org.apache.openjpa.util.Id` class for datastore identity objects. When writing OpenJPA plugins, you can manipulate datastore identity objects by casting them to this class. You can also create your own `Id` instances and pass them to any internal OpenJPA method that expects an identity object.

In JPA, you will never see `Id` instances directly. Instead, calling `OpenJPAEntityManager.getObjectId` on a datastore identity object will return the `Long` surrogate primary key value for that object. You can then use this value in calls to `EntityManager.find` for subsequent lookups of the same record.

### 5.4.2. Entities as Identity Fields

OpenJPA allows `ManyToOne` and `OneToOne` relations to be identity fields. To identify a relation field as an identity field, simply annotate it with both the `@ManyToOne` or `@OneToOne` relation annotation and the `@Id` identity annotation.

When finding an entity identified by a relation, pass the id of the *relation* to the `EntityManager.find` method:

#### *Example 5.5. Finding an Entity with an Entity Identity Field*

```
public Delivery createDelivery(Order order) {
```

```

        Delivery delivery = new Delivery();
        delivery.setId(order);
        delivery.setDelivered(new Date());
        return delivery;
    }

    public Delivery findDelivery(EntityManager em, Order order) {
        // use the identity of the related instance
        return em.find(Delivery.class, order.getId());
    }

```

When your entity has multiple identity fields, at least one of which is a relation to another entity, you can use an identity class (see [Section 4.2.1, “Identity Class” \[21\]](#) in the JPA Overview), or an embedded identity object. Identity class fields corresponding to entity identity fields should be of the same type as the related entity's identity. If an embedded identity object is used, you must annotate the relation field with both the `@ManyToOne` or `@OneToOne` relation annotation and the `@MapsId` annotation.

### *Example 5.6. Id Class for Entity Identity Fields*

```

@Entity
public class Order {

    @Id
    private long id;

    ...
}

/**
 * LineItem uses a compound primary key. Part of the compound key
 * LineItemId is relation or reference to Order instance.
 */
@Entity
@IdClass(LineItemId.class)
public class LineItem {

    @Id
    private int index;

    @Id
    @ManyToOne
    private Order order;

    ...
}

public class LineItemId {

    public int index;
    public long order; // same type as identity of Order i.e Order.id
                       // also the variable name must match the name of the
                       // variable in LineItem that refers to Order.
}

```

In the example above, if `Order` had used an identity class `OrderId` in place of a simple `long` value, then the `LineItemId.order` field would have been of type `OrderId`.

### *Example 5.7. Embedded Id for Entity Identity Fields*

```

@Entity
public class Order {

    @Id
    private long id;

```

```

    ...
}

/**
 * LineItem uses a compound primary key. Part of the compound key
 * LineItemId is relation or reference to Order instance.
 */
@Entity
public class LineItem {

    @EmbeddedId LineItemId id;

    @ManyToOne
    @MapsId("orderId") // The value element of the MapsId annotation
                      // must be used to specify the name of the primary
                      // key attribute to which the relationship
                      // corresponds. If the primary key referenced by
                      // the relationship attribute is of the same Java
                      // type as the dependent's primary key, then the
                      // value element is not specified.

    private Order order;

    ...
}

@Embeddable
public class LineItemId {

    public int index;
    public long orderId;

}

```

In the example above, the `LineItem` uses an embedded id to represent its primary key. The primary key attribute corresponding to the relationship in the `LineItemId` must be of the same type as the primary key of the `Order`. The `MapsId` annotation must be applied to the relationship field `LineItem.order`.

### 5.4.3. Application Identity Tool

If you choose to use application identity, you may want to take advantage of OpenJPA's application identity tool. The application identity tool generates Java code implementing the identity class for any persistent type using application identity. The code satisfies all the requirements the specification places on identity classes. You can use it as-is, or simply use it as a starting point, editing it to meet your needs.

Before you can run the application identity tool on a persistent class, the class must be compiled and must have complete metadata. All primary key fields must be marked as such in the metadata.

In JPA metadata, do not attempt to specify the `@IdClass` annotation unless you are using the application identity tool to overwrite an existing identity class. Attempting to set the value of the `@IdClass` to a non-existent class will prevent your persistent class from compiling. Instead, use the `-name` or `-suffix` options described below to tell OpenJPA what name to give your generated identity class. Once the application identity tool has generated the class code, you can set the `@IdClass` annotation.

The application identity tool can be invoked via its Java class, `org.apache.openjpa.enhance.ApplicationIdTool`.

#### Note

**Section 14.1.3, “Application Identity Tool Ant Task” [380]** describes the application identity tool's Ant task.

#### *Example 5.8. Using the Application Identity Tool*

```
java org.apache.openjpa.enhance.ApplicationIdTool -s Id Magazine.java
```

The application identity tool accepts the standard set of command-line arguments defined by the configuration framework (see [Section 2.3, “Command Line Configuration” \[208\]](#)), including code formatting flags described in [Section 2.3.1, “Code Formatting” \[209\]](#). It also accepts the following arguments:

- `-directory/-d <output directory>`: Path to the output directory. If the directory does not match the generated oid class' package, the package structure will be created beneath the directory. If not specified, the tool will first try to find the directory of the `.java` file for the persistence-capable class, and failing that will use the current directory.
- `-ignoreErrors/-i <true/t | false/f>`: If `false`, an exception will be thrown if the tool is run on any class that does not use application identity, or is not the base class in the inheritance hierarchy (recall that subclasses never define the application identity class; they inherit it from their persistent superclass).
- `-token/-t <token>`: The token to use to separate stringified primary key values in the string form of the object id. This option is only used if you have multiple primary key fields. It defaults to `":"`.
- `-name/-n <id class name>`: The name of the identity class to generate. If this option is specified, you must run the tool on exactly one class. If the class metadata already names an object id class, this option is ignored. If the name is not fully qualified, the persistent class' package is prepended to form the qualified name.
- `-suffix/-s <id class suffix>`: A string to suffix each persistent class name with to form the identity class name. This option is overridden by `-name` or by any object id class specified in metadata.

Each additional argument to the tool must be one of the following:

- The full name of a persistent class.
- The `.java` file for a persistent class.
- The `.class` file of a persistent class.

If you do not supply any arguments to the tool, it will act on the classes in your persistent classes list (see [Section 5.1, “Persistent Class List” \[274\]](#)).

## 5.4.4. Autoassign / Identity Strategy Caveats

[Section 5.2.4, “Generated Value” \[34\]](#) explains how to use JPA's `IDENTITY` generation type to automatically assign field values. However, here are some additional caveats you should be aware of when using `IDENTITY` generation:

1. Your database must support auto-increment / identity columns, or some equivalent (see [Section 4.4.4, “OracleDictionary Properties” \[259\]](#) for how to configure a combination of triggers and sequences to fake auto-increment support in Oracle database).
2. Auto-increment / identity columns must be an integer or long integer type.
3. Databases support auto-increment / identity columns to varying degrees. Some do not support them at all. Others only allow a single such column per table, and require that it be the primary key column. More lenient databases may allow non-primary key auto-increment columns, and may allow more than one per table. See your database documentation for details.

## 5.5. Managed Inverses

Bidirectional relations are an essential part of data modeling. [Chapter 13, \*Mapping Metadata\* \[147\]](#) in the JPA Overview explains how to use the `mappedBy` annotation attribute to form bidirectional relations that also share datastore storage in JPA.

OpenJPA also allows you to define purely logical bidirectional relations. The `org.apache.openjpa.persistence.InverseLogical` annotation names a logical inverse in JPA metadata.

**Example 5.9. Specifying Logical Inverses**

`Magazine.coverPhoto` and `Photograph.mag` are each mapped to different foreign keys in their respective tables, but form a logical bidirectional relation. Only one of the fields needs to declare the other as its logical inverse, though it is not an error to set the logical inverse of both fields.

```
import org.apache.openjpa.persistence.*;

@Entity
public class Magazine {

    @OneToOne
    private Photograph coverPhoto;

    ...
}

@Entity
public class Photograph {

    @OneToOne
    @InverseLogical("coverPhoto")
    private Magazine mag;

    ...
}
```

Java does not provide any native facilities to ensure that both sides of a bidirectional relation remain consistent. Whenever you set one side of the relation, you must manually set the other side as well.

By default, OpenJPA behaves the same way. OpenJPA does not automatically propagate changes from one field in bidirectional relation to the other field. This is in keeping with the philosophy of transparency, and also provides higher performance, as OpenJPA does not need to analyze your object graph to correct inconsistent relations.

If convenience is more important to you than strict transparency, however, you can enable inverse relation management in OpenJPA. Set the `openjpa.InverseManager` plugin property to `true` for standard management. Under this setting, OpenJPA detects changes to either side of a bidirectional relation (logical or physical), and automatically sets the other side appropriately on flush.

**Example 5.10. Enabling Managed Inverses**

```
<property name="openjpa.InverseManager" value="true"/>
```

The inverse manager has options to log a warning or throw an exception when it detects an inconsistent bidirectional relation, rather than correcting it. To use these modes, set the manager's `Action` property to `warn` or `exception`, respectively.

By default, OpenJPA excludes **large result set fields** from management. You can force large result set fields to be included by setting the `ManageLRS` plugin property to `true`.

**Example 5.11. Log Inconsistencies**

```
<property name="openjpa.InverseManager" value="true(Action=warn)"/>
```

## 5.6. Persistent Fields

OpenJPA enhances the specification's support for persistent fields in many ways. This section documents aspects of OpenJPA's persistent field handling that may affect the way you design your persistent classes.

### 5.6.1. Restoring State

While the JPA specification says that you should not use rolled back objects, such objects are perfectly valid in OpenJPA. You can control whether the objects' managed state is rolled back to its pre-transaction values with the `openjpa.RestoreState` configuration property. `none` does not roll back state (the object becomes hollow, and will re-load its state the next time it is accessed), `immutable` restores immutable values (primitives, primitive wrappers, strings) and clears mutable values so that they are reloaded on next access, and `all` restores all managed values to their pre-transaction state.

### 5.6.2. Typing and Ordering

When loading data into a field, OpenJPA examines the value you assign the field in your declaration code or in your no-args constructor. If the field value's type is more specific than the field's declared type, OpenJPA uses the value type to hold the loaded data. OpenJPA also uses the comparator you've initialized the field with, if any. Therefore, you can use custom comparators on your persistent field simply by setting up the comparator and using it in your field's initial value.

#### *Example 5.12. Using Initial Field Values*

Though the annotations are left out for simplicity, assume `employeesBySal` and `departments` are persistent fields in the class below.

```
public class Company {

    // OpenJPA will detect the custom comparator in the initial field value
    // and use it whenever loading data from the database into this field
    private Collection employeesBySal = new TreeSet(new SalaryComparator());
    private Map departments;

    public Company {
        // or we can initialize fields in our no-args constructor; even though
        // this field is declared type Map, OpenJPA will detect that it's
        // actually a TreeMap and use natural ordering for loaded data
        departments = new TreeMap();
    }

    // rest of class definition...
}
```

### 5.6.3. Calendar Fields and TimeZones

OpenJPA's support for the `java.util.Calendar` type will store only the `Date` part of the field, not the `TimeZone` associated with the field. When loading the date into the `Calendar` field, OpenJPA will use the `TimeZone` that was used to initialize the field.

### 5.6.4. Proxies

At runtime, the values of all mutable second class object fields in persistent and transactional objects are replaced with implementation-specific proxies. On modification, these proxies notify their owning instance that they have been changed, so that the appropriate updates can be made on the datastore.

#### 5.6.4.1. Smart Proxies



Most proxies only track whether or not they have been modified. Smart proxies for collection and map fields, however, keep a record of which elements have been added, removed, and changed. This record enables the OpenJPA runtime to make more efficient database updates on these fields.

When designing your persistent classes, keep in mind that you can optimize for OpenJPA smart proxies by using fields of type `java.util.Set`, `java.util.TreeSet`, and `java.util.HashSet` for your collections whenever possible. Smart proxies for these types are more efficient than proxies for `Lists`. You can also design your own smart proxies to further optimize OpenJPA for your usage patterns. See the section on **custom proxies** for details.

### 5.6.4.2. Large Result Set Proxies

Under standard ORM behavior, traversing a persistent collection or map field brings the entire contents of that field into memory. Some persistent fields, however, might represent huge amounts of data, to the point that attempting to fully instantiate them can overwhelm the JVM or seriously degrade performance.

OpenJPA uses special proxy types to represent these "large result set" fields. OpenJPA's large result set proxies do not cache any data in memory. Instead, each operation on the proxy offloads the work to the database and returns the proper result. For example, the `contains` method of a large result set collection will perform a `SELECT COUNT( *)` query with the proper `WHERE` conditions to find out if the given element exists in the database's record of the collection. Similarly, each time you obtain an iterator OpenJPA performs the proper query using the current **large result set settings**, as discussed in the **JDBC** chapter. As you invoke `Iterator.next`, OpenJPA instantiates the result objects on-demand.

You can free the resources used by a large result set iterator by passing it to the static `OpenJPAPersistence.close` method.

#### *Example 5.13. Using a Large Result Set Iterator*

```
import org.apache.openjpa.persistence.*;
...
Collection employees = company.getEmployees(); // employees is a lrs collection
Iterator itr = employees.iterator();
while (itr.hasNext())
    process((Employee) itr.next());
OpenJPAPersistence.close(itr);
```

You can also add and remove from large result set proxies, just as with standard fields. OpenJPA keeps a record of all changes to the elements of the proxy, which it uses to make sure the proper results are always returned from collection and map methods, and to update the field's database record on commit.

In order to use large result set proxies in JPA, add the `org.apache.openjpa.persistence.LRS` annotation to the persistent field.

The following restrictions apply to large result set fields:

- The field must be declared as either a `java.util.Collection` or `java.util.Map`. It cannot be declared as any other type, including any sub-interface of collection or map, or any concrete collection or map class.
- The field cannot have an externalizer (see **Section 5.6.5, “Externalization” [287]**).
- Because they rely on their owning object for context, large result set proxies cannot be transferred from one persistent field to another. The following code would result in an error on commit:

```
Collection employees = company.getEmployees() // employees is a lrs collection
company.setEmployees(null);
anotherCompany.setEmployees(employees);
```

### Example 5.14. Marking a Large Result Set Field

```
import org.apache.openjpa.persistence.*;

@Entity
public class Company {

    @ManyToMany
    @LRS private Collection<Employee> employees;

    ...
}
```

## 5.6.4.3. Custom Proxies

OpenJPA manages proxies through the `org.apache.openjpa.util.ProxyManager` interface. OpenJPA includes a default proxy manager, the `org.apache.openjpa.util.ProxyManagerImpl` (with a plugin alias name of `default`), that will meet the needs of most users. The default proxy manager understands the following configuration properties:

- `TrackChanges`: Whether to use **smart proxies**. Defaults to `true`.
- `AssertAllowedType`: Whether to immediately throw an exception if you attempt to add an element to a collection or map that is not assignable to the element type declared in metadata. Defaults to `false`.
- `DelayCollectionLoading`: Whether to delay loading elements of a lazily loaded collection. Delay loading allows non-indexed add and remove operations to occur without prior loading of the collection from the data store. This can improve performance of some applications by allowing them to perform simple add or remove operations on collections without requiring them to be loaded. Delayed proxies are loaded when an operation is performed that requires loading, such as iteration, size, serialization, and `indexOf`. They can also be loaded by casting the proxy to a `org.apache.openjpa.util.DelayedProxy` and invoking the `load` method. If a broker factory is available after detaching the owning entity, a collection may be available for delayed loading after the persistence context has been cleared. In post-detachment, entities that are loaded are not associated with a persistence context. Defaults to `false`.

The default proxy manager can proxy the standard methods of any `Collection`, `List`, `Map`, `Queue`, `Date`, or `Calendar` class, including custom implementations. It can also proxy custom classes whose accessor and mutator methods follow JavaBean naming conventions. Your custom types must, however, meet the following criteria:

- Custom container types must have a public no-arg constructor or a public constructor that takes a single `Comparator` parameter.
- Custom date types must have a public no-arg constructor or a public constructor that takes a single `long` parameter representing the current time.
- Other custom types must have a public no-arg constructor or a public copy constructor. If a custom types does not have a copy constructor, it must be possible to fully copy an instance A by creating a new instance B and calling each of B's setters with the value from the corresponding getter on A.

If you have custom classes that must be proxied and do not meet these requirements, OpenJPA allows you to define your own proxy classes and your own proxy manager. See the `openjpa.util` package **Javadoc** for details on the interfaces involved, and the utility classes OpenJPA provides to assist you.

You can plug your custom proxy manager into the OpenJPA runtime through the `openjpa.ProxyManager` configuration property.

**Example 5.15. Configuring the Proxy Manager**

```
<property name="openjpa.ProxyManager" value="TrackChanges=false" />
```

### 5.6.4.4. Serialization

When objects are serialized, the `DetachedStateField` in section **Section 12.1.3.1, “Detached State” [365]** will be used to help determine when build time proxies will be removed. If runtime created proxies are being used (proxies not supplied by OpenJPA) or if an entity has already been detached, then any found proxies will be removed during serialization.

- `transient`: Use a transient detached state field. This gives the benefits of a detached state field to local objects that are never serialized, but retains serialization compatibility for client tiers without access to the enhanced versions of your classes or the OpenJPA runtime. All proxies will be removed during serialization. This is the default.
- `true`: Use a non-transient detached state field so that objects crossing serialization barriers can still be attached efficiently. This requires, however, that your client tier have the enhanced versions of your classes and the OpenJPA runtime. No OpenJPA provided proxies will be removed during serialization.
- `false`: Do not use a detached state field. All proxies will be removed during serialization.

### 5.6.5. Externalization

OpenJPA offers the ability to write **custom field mappings** in order to have complete control over the mechanism with which fields are stored, queried, and loaded from the datastore. Often, however, a custom mapping is overkill. There is often a simple transformation from a Java field value to its database representation. Thus, OpenJPA provides the externalization service. Externalization allows you to specify methods that will externalize a field value to its database equivalent on store and then rebuild the value from its externalized form on load.

**Note**

Fields of embeddable classes used for `@EmbeddedId` values in JPA cannot have externalizers.

The OpenJPA `org.apache.openjpa.persistence.Externalizer` annotation sets the name of a method that will be invoked to convert the field into its external form for database storage. You can specify either the name of a non-static method, which will be invoked on the field value, or a static method, which will be invoked with the field value as a parameter. Each method can also take an optional `StoreContext` parameter for access to a persistence context. The return value of the method is the field's external form. By default, OpenJPA assumes that all named methods belong to the field value's class (or its superclasses). You can, however, specify static methods of other classes using the format `<class-name>.<method-name>`.

Given a field of type `CustomType` that externalizes to a string, the table below demonstrates several possible externalizer methods and their corresponding metadata extensions.

**Table 5.1. Externalizer Options**

Method	Extension
<code>public String CustomType.toString()</code>	<code>@Externalizer("toString")</code>

Method	Extension
public String CustomType.toString(StoreContext ctx)	@Externalizer("toString")
public static String AnyClass.toString(CustomType ct)	@Externalizer("AnyClass.toString")
public static String AnyClass.toString(CustomType ct, StoreContext ctx)	@Externalizer("AnyClass.toString")

The OpenJPA `org.apache.openjpa.persistence.Factory` annotation contains the name of a method that will be invoked to instantiate the field from the external form stored in the database. Specify a static method name. The method will be invoked with the externalized value and must return an instance of the field type. The method can also take an optional `StoreContext` parameter for access to a persistence context. If a factory is not specified, OpenJPA will use the constructor of the field type that takes a single argument of the external type, or will throw an exception if no constructor with that signature exists.

Given a field of type `CustomType` that externalizes to a string, the table below demonstrates several possible factory methods and their corresponding metadata extensions.

**Table 5.2. Factory Options**

Method	Extension
public CustomType(String str)	none
public static CustomType CustomType.fromString(String str)	@Factory("fromString")
public static CustomType CustomType.fromString(String str, StoreContext ctx)	@Factory("fromString")
public static CustomType AnyClass.fromString(String str)	@Factory("AnyClass.fromString")
public static CustomType AnyClass.fromString(String str, StoreContext ctx)	@Factory("AnyClass.fromString")

If your externalized field is not a standard persistent type, you must explicitly mark it persistent. In OpenJPA, you can force a persistent field by annotating it with `org.apache.openjpa.persistence.Persistent` annotation.

### Note

If your custom field type is mutable and is not a standard collection, map, or date class, OpenJPA will not be able to detect changes to the field. You must mark the field dirty manually, or create a custom field proxy. See `OpenJPAEntityManager.dirty` for how to mark a field dirty manually in JPA. See [Section 5.6.4, “Proxies” \[284\]](#) for a discussion of proxies.

You can externalize a field to virtually any value that is supported by OpenJPA's field mappings (embedded relations are the exception; you must declare your field to be a persistence-capable type in order to embed it). This means that a field can externalize to something as simple as a primitive, something as complex as a collection or map of entities, or anything in between. If you do choose to externalize to a collection or map, OpenJPA recognizes a family of metadata extensions for specifying type information for the externalized form of your fields - see [Section 6.4.2.6, “Type” \[301\]](#). If the external form of your field is an entity object or contains entities, OpenJPA will correctly include the objects in its persistence-by-reachability algorithms and its delete-dependent algorithms.

The example below demonstrates a few forms of externalization.

### **Example 5.16. Using Externalization**

```
import org.apache.openjpa.persistence.*;

@Entity
public class Magazine {

    // use Class.getName and Class.forName to go to/from strings
    @Persistent
    @Externalizer("getName")
    @Factory("forName")
    private Class cls;

    // use URL.getExternalForm for externalization. no factory;
    // we can rely on the URL string constructor
    @Persistent
    @Externalizer("toExternalForm")
    private URL url;

    // use our custom methods
    @Persistent
    @Externalizer("Magazine.authorsFromCustomType")
    @Factory("Magazine.authorsToCustomType")
    @ElementType(Author.class)
    private CustomType customType;

    public static Collection authorsFromCustomType(CustomType customType) {
        ... logic to pack custom type into a list of authors ...
    }

    public static CustomType authorsToCustomType(Collection authors) {
        ... logic to create custom type from a collection of authors ...
    }

    ...
}
```

You can query externalized fields using parameters. Pass in a value of the field type when executing the query. OpenJPA will externalize the parameter using the externalizer method named in your metadata, and compare the externalized parameter with the value stored in the database. As a shortcut, OpenJPA also allows you to use parameters or literals of the field's externalized type in queries, as demonstrated in the example below.

### **Note**

Currently, queries are limited to fields that externalize to a primitive, primitive wrapper, string, or date types, due to constraints on query syntax.

### **Example 5.17. Querying Externalization Fields**

Assume the Magazine class has the same fields as in the previous example.

```
// you can query using parameters
Query q = em.createQuery("select m from Magazine m where m.url = :u");
q.setParameter("u", new URL("http://www.solarmetric.com"));
List results = q.getResultList();

// or as a shortcut, you can use the externalized form directly
q = em.createQuery("select m from Magazine m where m.url = 'http://www.solarmetric.com'");
results = q.getResultList();
```

### 5.6.5.1. External Values

Externalization often takes simple constant values and transforms them to constant values of a different type. An example would be storing a `boolean` field as a `char`, where `true` and `false` would be stored in the database as 'T' and 'F' respectively.

OpenJPA allows you to define these simple translations in metadata, so that the field behaves as in **full-fledged externalization** without requiring externalizer and factory methods. External values supports translation of pre-defined simple types (primitives, primitive wrappers, and Strings), to other pre-defined simple values.

Use the OpenJPA `org.apache.openjpa.persistence.ExternalValues` annotation to define external value translations. The values are defined in a format similar to that of **configuration plugins**, except that the value pairs represent Java and datastore values. To convert the Java boolean values of `true` and `false` to the character values T and F, for example, you would use the extension value: `true=T, false=F`.

If the type of the datastore value is different from the field's type, use the `org.apache.openjpa.persistence.Type` annotation to define the datastore type.

#### *Example 5.18. Using External Values*

This example uses external value translation to transform a string field to an integer in the database.

```
public class Magazine {

    @ExternalValues({"SMALL=5", "MEDIUM=8", "LARGE=10"})
    @Type(int.class)
    private String sizeWidth;

    ...
}
```

## 5.7. Fetch Groups

Fetch groups are sets of fields that load together. They can be used to pool together associated fields in order to provide performance improvements over standard data fetching. Specifying fetch groups allows for tuning of lazy loading and eager fetching behavior.

The JPA Overview's **Section 5.2.7.1, “Fetch Type” [36]** describes how to use JPA metadata annotations to control whether a field is fetched eagerly or lazily. Fetch groups add a dynamic aspect to this standard ability. As you will see, OpenJPA's JPA extensions allow you can add and remove fetch groups at runtime to vary the sets of fields that are eagerly loaded.

### 5.7.1. Custom Fetch Groups

OpenJPA places any field that is eagerly loaded according to the JPA metadata rules into the built-in *default* fetch group. As its name implies, the default fetch group is active by default. You may also define your own named fetch groups and activate or deactivate them at runtime, as described later in this chapter. OpenJPA will eagerly-load the fields in all active fetch groups when loading objects from the datastore.

You create fetch groups with the `org.apache.openjpa.persistence.FetchGroup` annotation. If your class only has one custom fetch group, you can place this annotation directly on the class declaration. Otherwise, use the `org.apache.openjpa.persistence.FetchGroups` annotation to declare an array of individual `FetchGroup` values. The `FetchGroup` annotation has the following properties:

- `String name`: The name of the fetch group. Fetch group names are global, and are expected to be shared among classes. For example, a shopping website may use a *detail* fetch group in each product class to efficiently load all the data needed to display a product's "detail" page. The website might also define a sparse *list* fetch group containing only the fields needed to display a table of products, as in a search result.

The following names are reserved for use by OpenJPA: `default`, `values`, `all`, `none`, and any name beginning with `jdo`, `jpa`, or `openjpa`.

- `FetchAttribute[] attributes`: The set of persistent fields or properties in the fetch group.
- `String[] fetchGroups`: Other fetch groups whose fields to include in this group.

As you might expect, listing a `org.apache.openjpa.persistence.FetchAttribute` within a `FetchGroup` includes the corresponding persistent field or property in the fetch group. Each `FetchAttribute` has the following properties:

- `String name`: The name of the persistent field or property to include in the fetch group.
- `recursionDepth`: If the attribute represents a relation, the maximum number of same-typed relations to eager-fetch from this field. Defaults to 1. For example, consider an `Employee` class with a `manager` field, also of type `Employee`. When we load an `Employee` and the `manager` field is in an active fetch group, the recursion depth (along with the max fetch depth setting, described below) determines whether we only retrieve the target `Employee` and his manager (depth 1), or whether we also retrieve the manager's manager (depth 2), or the manager's manager's manager (depth 3), etc. Use -1 for unlimited depth.

### Example 5.19. Custom Fetch Group Metadata

Creates a *detail* fetch group consisting of the `publisher` and `articles` relations.

```
import org.apache.openjpa.persistence.*;

@Entity
@FetchGroups({
    @FetchGroup(name="detail", attributes={
        @FetchAttribute(name="publisher"),
        @FetchAttribute(name="articles")
    }),
    ...
})
public class Magazine {
    ...
}
```

A field can be a member of any number of fetch groups. A field can also declare a *load fetch group*. When you access a lazy-loaded field for the first time, OpenJPA makes a datastore trip to fetch that field's data. Sometimes, however, you know that whenever you access a lazy field A, you're likely to access lazy fields B and C as well. Therefore, it would be more efficient to fetch the data for A, B, and C in the same datastore trip. By setting A's load fetch group to the name of a **fetch group** containing B and C, you can tell OpenJPA to load all of these fields together when A is first accessed.

Use OpenJPA's `org.apache.openjpa.persistence.LoadFetchGroup` annotation to specify the load fetch group of any persistent field. The value of the annotation is the name of a declared fetch group whose members should be loaded along with the annotated field.

### Example 5.20. Load Fetch Group Metadata

```
import org.apache.openjpa.persistence.*;

@Entity
```

```

@FetchGroups({
    @FetchGroup(name="detail", attributes={
        @FetchAttribute(name="publisher"),
        @FetchAttribute(name="articles")
    }),
    ...
})
public class Magazine {

    @ManyToOne(fetch=FetchType.LAZY)
    @LoadFetchGroup("detail")
    private Publisher publisher;

    ...
}

```

## 5.7.2. Custom Fetch Group Configuration

You can control the default set of fetch groups with the `openjpa.FetchGroups` configuration property. Set this property to a comma-separated list of fetch group names.

You can also set the system's default maximum fetch depth with the `openjpa.MaxFetchDepth` configuration property. The maximum fetch depth determines how "deep" into the object graph to traverse when loading an instance. For example, with a `MaxFetchDepth` of 1, OpenJPA will load at most the target instance and its immediate relations. With a `MaxFetchDepth` of 2, OpenJPA may load the target instance, its immediate relations, and the relations of those relations. This works to arbitrary depth. In fact, the default `MaxFetchDepth` value is -1, which symbolizes infinite depth. Under this setting, OpenJPA will fetch configured relations until it reaches the edges of the object graph. Of course, which relation fields are loaded depends on whether the fields are eager or lazy, and on the active fetch groups. A fetch group member's recursion depth may also limit the fetch depth to something less than the configured maximum.

OpenJPA's `OpenJPAEntityManager` and `OpenJPAQuery` extensions to the standard `EntityManager` and `Query` interfaces provide access to a `org.apache.openjpa.persistence.FetchPlan` object. The `FetchPlan` maintains the set of active fetch groups and the maximum fetch depth. It begins with the groups and depth defined in the `openjpa.FetchGroups` and `openjpa.MaxFetchDepth` properties, but allows you to add or remove groups and change the maximum fetch depth for an individual `EntityManager` or `Query` through the methods below.

```

public FetchPlan addFetchGroup(String group);
public FetchPlan addFetchGroups(String... groups);
public FetchPlan addFetchGroups(Collection groups);
public FetchPlan removeFetchGroup(String group);
public FetchPlan removeFetchGroups(String... groups);
public FetchPlan removeFetchGroups(Collection groups);
public FetchPlan resetFetchGroups();
public Collection<String> getFetchGroups();
public void clearFetchGroups();
public FetchPlan setMaxFetchDepth(int depth);
public int getMaxFetchDepth();

```

**Chapter 9, *Runtime Extensions* [335]** details the `OpenJPAEntityManager`, `OpenJPAQuery`, and `FetchPlan` interfaces.

### *Example 5.21. Using the FetchPlan*

```

import org.apache.openjpa.persistence.*;

...

OpenJPAQuery kg = OpenJPAPersistence.cast(em.createQuery(...));

```



```
kq.getFetchPlan().setMaxFetchDepth(3).addFetchGroup("detail");
List results = kq.getResultList();
```

### 5.7.3. Per-field Fetch Configuration

In addition to controlling fetch configuration on a per-fetch-group basis, you can configure OpenJPA to include particular fields in the current fetch plan. This allows you to add individual fields that are not in the default fetch group or in any other active fetch groups to the set of fields that will be eagerly loaded from the database.

OpenJPA `FetchPlan` methods:

```
public FetchPlan addField(String field);
public FetchPlan addFields(String... fields);
public FetchPlan addFields(Class cls, String... fields);
public FetchPlan addFields(Collection fields);
public FetchPlan addFields(Class cls, Collection fields);
public FetchPlan removeField(String field);
public FetchPlan removeFields(String... fields);
public FetchPlan removeFields(Class cls, String... fields);
public FetchPlan removeFields(Collection fields);
public FetchPlan removeFields(Class cls, Collection fields);
public Collection<String> getFields();
public void clearFields();
```

The methods that take only string arguments use the fully-qualified field name, such as `org.mag.Magazine.publisher`. Similarly, `getFields` returns the set of fully-qualified field names. In all methods, the named field must be defined in the class specified in the invocation, not a superclass. So, if the field `publisher` is defined in base class `Publication` rather than subclass `Magazine`, you must invoke `addField (Publication.class, "publisher")` and not `addField (Magazine.class, "publisher")`. This is stricter than Java's default field-masking algorithms, which would allow the latter method behavior if `Magazine` did not also define a field called `publisher`.

To include the fields defined in a super class by the subclass or to distinguish between fields that are defined in *both* super- and subclass, set `setExtendedPathLookup(boolean)` on `FetchPlan` to `true`. By default, this option is set to `false`, to reduce more extensive lookups for predominant use cases.

In order to avoid the cost of reflection, OpenJPA does not perform any validation of the field name / class name pairs that you put into the fetch configuration. If you specify non-existent class / field pairs, nothing adverse will happen, but you will receive no notification of the fact that the specified configuration is not being used.

#### *Example 5.22. Adding an Eager Field*

```
import org.apache.openjpa.persistence.*;

...

OpenJPAEntityManager kem = OpenJPAPersistence.cast(em);
kem.getFetchPlan().addField(Magazine.class, "publisher");
Magazine mag = em.find(Magazine.class, magId);
```

### 5.7.4. Implementation Notes

- Even when a direct relation is not eagerly fetched, OpenJPA selects the foreign key columns and caches the values. This way when you do traverse the relation, OpenJPA can often find the related object in its cache, or at least avoid joins when loading the related object from the database.

- The above implicit foreign key-selecting behavior does not always apply when the relation is in a subclass table. If the subclass table would not otherwise be joined into the select, OpenJPA avoids the extra join just to select the foreign key values.

## 5.8. Eager Fetching

Eager fetching is the ability to efficiently load subclass data and related objects along with the base instances being queried. Typically, OpenJPA has to make a trip to the database whenever a relation is loaded, or when you first access data that is mapped to a table other than the least-derived superclass table. If you perform a query that returns 100 `Person` objects, and then you have to retrieve the `Address` for each person, OpenJPA may make as many as 101 queries (the initial query, plus one for the address of each person returned). Or if some of the `Person` instances turn out to be `Employees`, where `Employee` has additional data in its own joined table, OpenJPA once again might need to make extra database trips to access the additional employee data. With eager fetching, OpenJPA can reduce these cases to a single query.

Eager fetching only affects relations in the active fetch groups, and is limited by the declared maximum fetch depth and field recursion depth (see [Section 5.7, “Fetch Groups” \[290\]](#)). In other words, relations that would not normally be loaded immediately when retrieving an object or accessing a field are not affected by eager fetching. In our example above, the address of each person would only be eagerly fetched if the query were configured to include the address field or its fetch group, or if the address were in the default fetch group. This allows you to control exactly which fields are eagerly fetched in different situations. Similarly, queries that exclude subclasses aren't affected by eager subclass fetching, described below.

Eager fetching has three modes:

- `none`: No eager fetching is performed. Related objects are always loaded in an independent select statement. No joined subclass data is loaded unless it is in the table(s) for the base type being queried. Unjoined subclass data is loaded using separate select statements rather than a SQL UNION operation.
- `join`: In this mode, OpenJPA joins to to-one relations in the configured fetch groups. If OpenJPA is loading data for a single instance, then OpenJPA will also join to any collection field in the configured fetch groups. When loading data for multiple instances, though, (such as when executing a `Query`) OpenJPA will not join to collections by default. Instead, OpenJPA defaults to `parallel` mode for collections, as described below. You can force OpenJPA use a join rather than parallel mode for a collection field using the metadata extension described in [Section 7.9.2.1, “Eager Fetch Mode” \[329\]](#).

Under `join` mode, OpenJPA uses a left outer join (or inner join, if the relations' field metadata declares the relation non-nullable) to select the related data along with the data for the target objects. This process works recursively for to-one joins, so that if `Person` has an `Address`, and `Address` has a `TelephoneNumber`, and the fetch groups are configured correctly, OpenJPA might issue a single select that joins across the tables for all three classes. To-many joins can not recursively spawn other to-many joins, but they can spawn recursive to-one joins.

Under the `join` subclass fetch mode, subclass data in joined tables is selected by outer joining to all possible subclass tables of the type being queried. As you'll see below, subclass data fetching is configured separately from relation fetching, and can be disabled for specific classes.

### Note

Some databases may not support outer joins. Also, OpenJPA can not use outer joins if you have set the `DBDictionary`'s `JoinSyntax` to `traditional`. See [Section 4.6, “Setting the SQL Join Syntax” \[261\]](#).

- `parallel`: Under this mode, OpenJPA selects to-one relations and joined collections as outlined in the `join` mode description above. Unjoined collection fields, however, are eagerly fetched using a separate select statement for each collection, executed in parallel with the select statement for the target objects. The parallel selects use the `WHERE` conditions from the primary select, but add their own joins to reach the related data. Thus, if you perform a query that returns 100 `Company` objects, where each company has a list of `Employee` objects and `Department` objects, OpenJPA will make 3 queries. The first will select the company objects, the second will select the employees for those companies, and the third will select the departments for the same companies. Just as for joins, this process can be recursively applied to the objects in the

relations being eagerly fetched. Continuing our example, if the `Employee` class had a list of `Projects` in one of the fetch groups being loaded, OpenJPA would execute a single additional select in parallel to load the projects of all employees of the matching companies.

Using an additional select to load each collection avoids transferring more data than necessary from the database to the application. If eager joins were used instead of parallel select statements, each collection added to the configured fetch groups would cause the amount of data being transferred to rise dangerously, to the point that you could easily overwhelm the network.

Polymorphic to-one relations to table-per-class mappings use parallel eager fetching because proper joins are impossible. You can force other to-one relations to use parallel rather than join mode eager fetching using the metadata extension described in [Section 7.9.2.1, “Eager Fetch Mode” \[329\]](#).

Parallel subclass fetch mode only applies to queries on joined inheritance hierarchies. Rather than outer-joining to subclass tables, OpenJPA will issue the query separately for each subclass. In all other situations, parallel subclass fetch mode acts just like join mode in regards to vertically-mapped subclasses.

When OpenJPA knows that it is selecting for a single object only, it never uses parallel mode, because the additional selects can be made lazily just as efficiently. This mode only increases efficiency over join mode when multiple objects with eager relations are being loaded, or when multiple selects might be faster than joining to all possible subclasses.

## 5.8.1. Configuring Eager Fetching

You can control OpenJPA's default eager fetch mode through the `openjpa.jdbc.EagerFetchMode` and `openjpa.jdbc.SubclassFetchMode` configuration properties. Set each of these properties to one of the mode names described in the previous section: `none`, `join`, `parallel`. If left unset, the eager fetch mode defaults to `parallel` and the subclass fetch mode defaults to `join`. These are generally the most robust and performant strategies.

You can easily override the default fetch modes at runtime for any lookup or query through OpenJPA's fetch configuration APIs. See [Chapter 9, Runtime Extensions \[335\]](#) for details.

### *Example 5.23. Setting the Default Eager Fetch Mode*

```
<property name="openjpa.jdbc.EagerFetchMode" value="parallel"/>
<property name="openjpa.jdbc.SubclassFetchMode" value="join"/>
```

### *Example 5.24. Setting the Eager Fetch Mode at Runtime*

```
import org.apache.openjpa.persistence.*;
import org.apache.openjpa.persistence.jdbc.*;

...

Query q = em.createQuery("select p from Person p where p.address.state = 'TX'");
OpenJPAQuery kq = OpenJPAPersistence.cast(q);
JDBCFetchPlan fetch = (JDBCFetchPlan) kq.getFetchPlan();
fetch.setEagerFetchMode(FetchMode.PARALLEL);
fetch.setSubclassFetchMode(FetchMode.JOIN);
List results = q.getResultList();
```

You can specify a default subclass fetch mode for an individual class with the metadata extension described in [Section 7.9.1.1, “Subclass Fetch Mode” \[329\]](#). Note, however, that you cannot "upgrade" the runtime fetch mode with your class setting. If the runtime fetch mode is `none`, no eager subclass data fetching will take place, regardless of your metadata setting.

This applies to the eager fetch mode metadata extension as well (see [Section 7.9.2.1, “Eager Fetch Mode” \[329\]](#)). You can use this extension to disable eager fetching on a field or to declare that a collection would rather use joins than parallel selects or vice versa. But an extension value of `join` won't cause any eager joining if the fetch configuration's setting is `none`.

## 5.8.2. Eager Fetching Considerations and Limitations

---

There are several important points that you should consider when using eager fetching:

- When you are using `parallel` eager fetch mode and you have large result sets enabled (see [Section 4.10, “Large Result Sets” \[265\]](#)) or you place a range on a query, OpenJPA performs the needed parallel selects on one page of results at a time. For example, suppose your `FetchBatchSize` is set to 20, and you perform a large result set query on a class that has collection fields in the configured fetch groups. OpenJPA will immediately cache the first 20 results of the query using `join` mode eager fetching only. Then, it will issue the extra selects needed to eager fetch your collection fields according to `parallel` mode. Each select will use a SQL `IN` clause (or multiple `OR` clauses if your class has a compound primary key) to limit the selected collection elements to those owned by the 20 cached results.

Once you iterate past the first 20 results, OpenJPA will cache the next 20 and again issue any needed extra selects for collection fields, and so on. This pattern ensures that you get the benefits of eager fetching without bringing more data into memory than anticipated.

- Once OpenJPA eager-joins into a class, it cannot issue any further eager to-many joins or parallel selects from that class in the same query. To-one joins, however, can recurse to any level.
- Using a to-many join makes it impossible to determine the number of instances the result set contains without traversing the entire set. This is because each result object might be represented by multiple rows. Thus, queries with a range specification or queries configured for lazy result set traversal automatically turn off eager to-many joining.
- OpenJPA cannot eagerly join to polymorphic relations to non-leaf classes in a table-per-class inheritance hierarchy. You can work around this restriction using the mapping extensions described in [Section 7.9.2.2, “Nonpolymorphic” \[329\]](#).

---

# Chapter 6. Metadata

The JPA Overview covers JPA metadata in [Chapter 5, \*Metadata\*](#) [27]. This chapter discusses OpenJPA's extensions to standard JPA metadata.

## 6.1. Metadata Factory

---

The `openjpa.MetadataFactory` configuration property controls metadata loading and storing. This property takes a plugin string (see [Section 2.4, “Plugin Configuration”](#) [210]) describing a concrete `org.apache.openjpa.meta.MetadataFactory` implementation. A metadata factory can load mapping information as well as persistence metadata, or it can leave mapping information to a separate *mapping factory* (see [Section 7.5, “Mapping Factory”](#) [313]). OpenJPA recognizes the following built-in metadata factories:

- `jpa`: Standard JPA metadata. This is an alias for the `org.apache.openjpa.persistence.PersistenceMetadataFactory`.

JPA has built-in settings for listing your persistent classes, which the [JPA Overview](#) describes. OpenJPA supports these JPA standard settings by translating them into its own internal metadata factory properties. Each internal property represents a different mechanism for locating persistent types; you can choose the mechanism or combination of mechanisms that are most convenient. See [Section 5.1, “Persistent Class List”](#) [274] for a discussion of when it is necessary to list your persistent classes.

- `Types`: A semicolon-separated list of fully-qualified persistent class names.
- `Resources`: A semicolon-separated list of resource paths to metadata files or jar archives. Each jar archive will be scanned for annotated JPA entities.
- `URLs`: A semicolon-separated list of URLs of metadata files or jar archives. Each jar archive will be scanned for annotated JPA entities.
- `ClasspathScan`: A semicolon-separated list of directories or jar archives listed in your classpath. Each directory and jar archive will be scanned for annotated JPA entities.

### *Example 6.1. Setting a Standard Metadata Factory*

```
<property name="openjpa.MetadataFactory" value="jpa(ClasspathScan=build;lib.jar)"/>
```

### *Example 6.2. Setting a Custom Metadata Factory*

```
<property name="openjpa.MetadataFactory" value="com.xyz.CustomMetadataFactory"/>
```

## 6.2. Metadata Repository

---

The `openjpa.MetadataRepository` configuration property controls the configuration of the `MetadataRepository`. The following are valid properties:

- `Preload`: A boolean property. If true, OpenJPA will eagerly load the repository on `EntityManagerFactory` creation. As a result, all Entity classes will be eagerly loaded by the JVM. Once `Metadata` preloading completes, all locking is removed from

the `MetadataRepository` and this will result in a much more scalable repository. If false, the repository will be lazily loaded as Entity classes are loaded by the JVM. The default value is false.

### Example 6.3. Setting the Preload Property on Metadata Repository

```
<property name="openjpa.MetadataRepository" value="Preload=true"/>
```

## 6.3. Additional JPA Metadata

This section describes OpenJPA's core additions to standard entity metadata. We present the object-relational mapping syntax to support these additions in [Section 7.7, “Additional JPA Mappings” \[315\]](#). Finally, [Section 6.4, “Metadata Extensions” \[299\]](#) covers additional extensions to JPA metadata that allow you to access auxiliary OpenJPA features.

### 6.3.1. Datastore Identity

JPA typically requires you to declare one or more `Id` fields to act as primary keys. OpenJPA, however, can create and maintain a surrogate primary key value when you do not declare any `Id` fields. This form of persistent identity is called *datastore identity*. [Section 5.4, “Object Identity” \[279\]](#) discusses OpenJPA's support for datastore identity in JPA. We cover how to map your datastore identity primary key column in [Section 7.7.1, “Datastore Identity Mapping” \[315\]](#)

### 6.3.2. Surrogate Version

Just as OpenJPA can maintain your entity's identity without any `Id` fields, OpenJPA can maintain your entity's optimistic version without any `Version` fields. [Section 7.7.2, “Surrogate Version Mapping” \[316\]](#) shows you how to map surrogate version columns.

### 6.3.3. Persistent Field Values

JPA defines `Basic`, `Lob`, `Embedded`, `ManyToOne`, and `OneToOne` persistence strategies for direct field values. OpenJPA supports all of these standard strategies, but adds one of its own: `Persistent`. The `org.apache.openjpa.persistence.Persistent` metadata annotation can represent any direct field value, including custom types. It has the following properties:

- `FetchType fetch`: Whether to load the field eagerly or lazily. Corresponds exactly to the same-named property of standard JPA annotations such as `Basic`. Defaults to `FetchType.EAGER`.
- `CascadeType[] cascade`: Array of enum values defining cascade behavior for this field. Corresponds exactly to the same-named property of standard JPA annotations such as `ManyToOne`. Defaults to empty array.
- `String mappedBy`: Names the field in the related entity that maps this bidirectional relation. Corresponds to the same-named property of standard JPA annotations such as `OneToOne`.
- `boolean optional`: Whether the value can be null. Corresponds to the same-named property of standard JPA annotations such as `ManyToOne`, but can apply to non-entity object values as well. Defaults to `true`.
- `boolean embedded`: Set this property to `true` if the field value is stored as an embedded object.

Though you can use the `Persistent` annotation in place of most of the standard direct field annotations mentioned above, we recommend primarily using it for non-standard and custom types for which no standard JPA annotation exists. For example, [Section 7.7.3, “Multi-Column Mappings” \[317\]](#) demonstrates the use of the `Persistent` annotation to denote a persistent `java.awt.Point` field.

## 6.3.4. Persistent Collection Fields

---

JPA standardizes support for collections of entities with the `OneToMany` and `ManyToMany` persistence strategies. OpenJPA supports these strategies, and may be extended for other strategies as well. For extended strategies, use the `org.apache.openjpa.persistence.PersistentCollection` metadata annotation to represent any persistent collection field. It has the following properties:

- `Class elementType`: The class of the collection elements. This information is usually taken from the parameterized collection element type. You must supply it explicitly, however, if your field isn't a parameterized type.
- `FetchType fetch`: Whether to load the collection eagerly or lazily. Corresponds exactly to the same-named property of standard JPA annotations such as `Basic`. Defaults to `FetchType.LAZY`.
- `String mappedBy`: Names the field in the related entity that maps this bidirectional relation. Corresponds to the same-named property of standard JPA annotations such as `ManyToMany`.
- `CascadeType[] elementCascade`: Array of enum values defining cascade behavior for the collection elements. Corresponds exactly to the `cascade` property of standard JPA annotations such as `ManyToMany`. Defaults to empty array.
- `boolean elementEmbedded`: Set this property to `true` if the elements are stored as embedded objects.

## 6.3.5. Persistent Map Fields

---

JPA has limited support for maps. If you extend JPA's standard map support to encompass new mappings, use the `org.apache.openjpa.persistence.PersistentMap` metadata annotation to represent your custom persistent map fields. It has the following properties:

- `Class keyType`: The class of the map keys. This information is usually taken from the parameterized map key type. You must supply it explicitly, however, if your field isn't a parameterized type.
- `Class elementType`: The class of the map values. This information is usually taken from the parameterized map value type. You must supply it explicitly, however, if your field isn't a parameterized type.
- `FetchType fetch`: Whether to load the collection eagerly or lazily. Corresponds exactly to the same-named property of standard JPA annotations such as `Basic`. Defaults to `FetchType.LAZY`.
- `CascadeType[] keyCascade`: Array of enum values defining cascade behavior for the map keys. Corresponds exactly to the `cascade` property of standard JPA annotations such as `ManyToOne`. Defaults to empty array.
- `CascadeType[] elementCascade`: Array of enum values defining cascade behavior for the map values. Corresponds exactly to the `cascade` property of standard JPA annotations such as `ManyToOne`. Defaults to empty array.
- `boolean keyEmbedded`: Set this property to `true` if the map keys are stored as embedded objects.
- `boolean elementEmbedded`: Set this property to `true` if the map values are stored as embedded objects.

## 6.4. Metadata Extensions

---

OpenJPA extends standard metadata to allow you to access advanced OpenJPA functionality. This section covers persistence metadata extensions; we discuss mapping metadata extensions in [Section 7.9, “Mapping Extensions” \[328\]](#). All metadata extensions are optional; OpenJPA will rely on its defaults when no explicit data is provided.

### 6.4.1. Class Extensions

---

OpenJPA recognizes the following class extensions:



### 6.4.1.1. Fetch Groups

---

The `org.apache.openjpa.persistence.FetchGroups` and `org.apache.openjpa.persistence.FetchGroup` annotations allow you to define fetch groups in your JPA entities. Section 5.7, “Fetch Groups” [290] discusses OpenJPA’s support for fetch groups in general; see Section 5.7.1, “Custom Fetch Groups” [290] for how to use these annotations in particular.

### 6.4.1.2. Data Cache

---

Section 10.1, “Data Cache” [348] examines caching in OpenJPA. Metadata extensions allow individual classes to override system caching defaults.

OpenJPA defines the `org.apache.openjpa.persistence.DataCache` annotation for caching information. This annotation has the following properties:

- `boolean enabled`: Whether to cache data for instances of the class. Defaults to `true` for base classes, or the superclass value for subclasses. If you set this property to `false`, all other properties are ignored.
- `int timeout`: The number of milliseconds data for the class remains valid. Use `-1` for no timeout. Defaults to the `openjpa.DataCacheTimeout` property value.

### 6.4.1.3. Detached State

---

The OpenJPA **enhancer** may add a synthetic field to detachable classes to hold detached state (see Section 12.1.3, “Defining the Detached Object Graph” [365] for details). You can instead declare your own detached state field or suppress the creation of a detached state field altogether. In the latter case, your class must not use **datastore identity**, and should declare a version field to detect optimistic concurrency errors during detached modifications.

OpenJPA defines the `org.apache.openjpa.persistence.DetachedState` annotation for controlling detached state. When used to annotate a class, `DetachedState` recognizes the following properties:

- `boolean enabled`: Set to `false` to suppress the use of detached state.
- `String fieldName`: Use this property to declare your own detached state field. The field must be of type `Object`. Typically this property is only used if the field is inherited from a non-persisted superclass. If the field is declared in your entity class, you will typically annotate the field directly, as described below.

If you declare your own detached state field, you can annotate that field with `DetachedState` directly, rather than placing the annotation at the class level and using the `fieldName` property. When placed on a field, `DetachedState` acts as a marker annotation; it does not recognize any properties. Your annotated field must be of type `Object`.

## 6.4.2. Field Extensions

---

OpenJPA recognizes the following field extensions:

### 6.4.2.1. Dependent

---

In a *dependent* relation, the referenced object is deleted whenever the owning object is deleted, or whenever the relation is severed by nulling or resetting the owning field. For example, if the `Magazine.coverArticle` field is marked dependent, then setting `Magazine.coverArticle` to a new `Article` instance will automatically delete the old `Article` stored in the field. Similarly, deleting a `Magazine` object will automatically delete its current `coverArticle`. (This latter processing is analogous to using JPA’s `CascadeType.REMOVE` functionality as described in Section 5.2.9.1, “Cascade Type” [37].) You can prevent an orphaned dependent object from being automatically deleted by assigning it to another relation in the same transaction.



OpenJPA offers a family of marker annotations to denote dependent relations in JPA entities:

- `org.apache.openjpa.persistence.Dependent`: Marks a direct relation as dependent.
- `org.apache.openjpa.persistence.ElementDependent`: Marks the entity elements of a collection, array, or map field as dependent.
- `org.apache.openjpa.persistence.KeyDependent`: Marks the key entities in a map field as dependent.

---

### 6.4.2.2. Load Fetch Group

---

The `org.apache.openjpa.persistence.LoadFetchGroup` annotation specifies a field's load fetch group. Section 5.7, “Fetch Groups” [290] discusses OpenJPA's support for fetch groups in general; see Section 5.7.1, “Custom Fetch Groups” [290] for how to use this annotation in particular.

---

### 6.4.2.3. LRS

---

This boolean extension, denoted by the OpenJPA `org.apache.openjpa.persistence.LRS` annotation, indicates that a field should use OpenJPA's special large result set collection or map proxies. A complete description of large result set proxies is available in Section 5.6.4.2, “Large Result Set Proxies” [285].

---

### 6.4.2.4. Inverse-Logical

---

This extension names the inverse field in a logical bidirectional relation. To create a logical bidirectional relation in OpenJPA, use the `org.apache.openjpa.persistence.InverseLogical` annotation. We discuss logical bidirectional relations and this extension in detail in Section 5.5, “Managed Inverses” [282].

---

### 6.4.2.5. Read-Only

---

The read-only extension makes a field unwritable. The extension only applies to existing persistent objects; new object fields are always writable.

To mark a field read-only in JPA metadata, set the `org.apache.openjpa.persistence.ReadOnly` annotation to an `org.apache.openjpa.persistence.UpdateAction` enum value. The `UpdateAction` enum includes:

- `UpdateAction.IGNORE`: Updates to the field are completely ignored. The field is not considered dirty. The new value will not even get stored in the OpenJPA **data cache**.
- `UpdateAction.RESTRICT`: Any attempt to change the field will result in an immediate exception.

---

### 6.4.2.6. Type

---

OpenJPA has three levels of support for relations:

1. Relations that hold a reference to an object of a concrete persistent class are supported by storing the primary key values of the related instance in the database.
2. Relations that hold a reference to an object of an unknown persistent class are supported by storing the stringified identity value of the related instance. This level of support does not allow queries across the relation.
3. Relations that hold an unknown object or interface. The only way to support these relations is to serialize their value to the database. This does not allow you to query the field, and is not very efficient.

Clearly, when you declare a field's type to be another persistence-capable class, OpenJPA uses level 1 support. By default, OpenJPA assumes that any interface-typed fields you declare will be implemented only by other persistent classes, and assigns

interfaces level 2 support. The exception to this rule is the `java.io.Serializable` interface. If you declare a field to be of type `Serializable`, OpenJPA lumps it together with `java.lang.Object` fields and other non-interface, unrecognized field types, which are all assigned level 3 support.

With OpenJPA's type family of metadata extensions, you can control the level of support given to your unknown/interface-typed fields. Setting the value of this extension to `Entity` indicates that the field value will always be some persistent object, and gives level 2 support. Setting the value of this extension to the class of a concrete persistent type is even better; it gives you level 1 support (just as if you had declared your field to be of that type in the first place). Setting this extension to `Object` uses level 3 support. This is useful when you have an interface relation that may **not** hold other persistent objects (recall that OpenJPA assumes interface fields will always hold persistent instances by default).

This extension is also used with OpenJPA's externalization feature, described in [Section 5.6.5, “Externalization” \[287\]](#).

OpenJPA defines the following type annotations for field values, collection, array, and map elements, and map keys, respectively:

- `org.apache.openjpa.persistence.Type`
- `org.apache.openjpa.persistence.ElementType`
- `org.apache.openjpa.persistence.KeyType`

### 6.4.2.7. Externalizer

The OpenJPA `org.apache.openjpa.persistence.Externalizer` annotation names a method to transform a field value into a value of another type. See [Section 5.6.5, “Externalization” \[287\]](#) for details.

### 6.4.2.8. Factory

The OpenJPA `org.apache.openjpa.persistence.Factory` annotation names a method to re-create a field value from its externalized form. See [Section 5.6.5, “Externalization” \[287\]](#) for details.

### 6.4.2.9. External Values

The OpenJPA `org.apache.openjpa.persistence.ExternalValues` annotation declares values for transformation of simple fields to different constant values in the datastore. See [Section 5.6.5.1, “External Values” \[290\]](#) for details.

## 6.4.3. Example

The following example shows you how to specify extensions in metadata.

### *Example 6.4. OpenJPA Metadata Extensions*

```
import org.apache.openjpa.persistence.*;

@Entity
@DataCache(enabled=false)
public class Magazine
{
    @ManyToMany
    @LRS
    private Collection<Subscriber> subscribers;

    @ExternalValues({"true=1", "false=2"})
    @Type(int.class)
    private boolean weekly;

    ...
}
```

}

## 6.4.4. XML extensions

OpenJPA has extended the JPA 2.0 schema to include elements and attributes corresponding to OpenJPA extended metadata and mapping annotations. The schema are contained in 2 files: **extendable-orm.xsd** and **openjpa-orm.xsd**. The extendable-orm.xsd file provides copies of some of the JPA 2.0 schema elements with additional schema to make it extendable. The openjpa-orm.xsd file extends the extendable-orm.xsd with OpenJPA specific elements and attributes representing OpenJPA annotations. Currently, only a subset of annotations have actually been implemented, and some of those have been partially tested. The current status can be found by comments in the **openjpa-orm.xsd** schema file.

In order to use the OpenJPA extensions in your mapping file you must include the namespaces for these 2 new schemas as well as for the schema for JPA 2.0, as shown in the following example:

### *Example 6.5. OpenJPA Schema Extensions*

```
<entity-mappings xmlns="http://www.apache.org/openjpa/ns/orm/extendable"
  xmlns:openjpa="http://www.apache.org/openjpa/ns/orm"
  xmlns:orm="http://java.sun.com/xml/ns/persistence/orm"
  xmlns:xsi="http://www.w3.org/2001/XMLSchema-instance"
  version="2.0">

  <entity class="org.apache.openjpa.persistence.jdbc.annotations.MultiColumnVersionPC"
    metadata-complete="true">
    <table name="MCV"/>
    <attributes>
      <id name="id">
        <orm:generated-value/>
      </id>
      <basic name="id"/>
      <basic name="name"/>
    </attributes>
    <openjpa:entity version-strategy="version-numbers">
      <openjpa:version-columns>
        <openjpa:version-column name="v1"/>
        <openjpa:version-column name="v2"/>
        <openjpa:version-column name="v3"
          column-definition="FLOAT"
          scale="3"
          precision="10"/>
      </openjpa:version-columns>
    </openjpa:entity>
  </entity>

</entity-mappings>
```

---

# Chapter 7. Mapping

The JPA Overview's [Chapter 13, \*Mapping Metadata\*](#) [147] explains object-relational mapping under JPA. This chapter reviews the mapping utilities OpenJPA provides and examines OpenJPA features that go beyond the JPA specification.

## 7.1. Forward Mapping

---

*Forward mapping* is the process of creating mappings and their corresponding database schema from your object model. OpenJPA supports forward mapping through the *mapping tool*. The next section presents several common mapping tool use cases. You can invoke the tool through its Java class, `org.apache.openjpa.jdbc.meta.MappingTool`.

### Note

[Section 14.1.4, “Mapping Tool Ant Task”](#) [381] describes the mapping tool Ant task.

### Example 7.1. Using the Mapping Tool

```
java org.apache.openjpa.jdbc.meta.MappingTool Magazine.java
```

In addition to the universal flags of the **configuration framework**, the mapping tool accepts the following command line arguments:

- `-schemaAction/-sa <add | refresh | drop | build | retain | reflect | createDB | dropDB | import | export | none>`: The action to take on the schema. These options correspond to the same-named actions on the schema tool described in [Section 4.13, “Schema Tool”](#) [268]. Actions can be composed in a comma-separated list. Unless you are running the mapping tool on all of your persistent types at once or dropping a mapping, we strongly recommend you use the default `add` action or the `build` action. Otherwise you may end up inadvertently dropping schema components that are used by classes you are not currently running the tool over.
- `-schemaFile/-sf <stdout | output file>`: Use this option to write the planned schema to an XML document rather than modify the database. The document can then be manipulated and committed to the database with the **schema tool**.
- `-sqlFile/-sql <stdout | output file>`: Use this option to write the planned schema modifications to a SQL script rather than modify the database. Combine this with a `schemaAction` of `build` to generate a script that recreates the schema for the current mappings, even if the schema already exists.
- `-sqlEncode/-se <encoding>`: Use this option with `-sqlFile` to write the SQL script in a different Java character set encoding than the default JVM locale, such as `-sqlTerminator/-st <terminal>`: Use this option with `-sqlFile` to write the SQL terminating with a different character instead of a semicolon.
- `-dropTables/-dt <true/t | false/f>`: Corresponds to the same-named option on the schema tool.
- `-dropSequences/-dsq <true/t | false/f>`: Corresponds to the same-named option on the schema tool.
- `-openjpaTables/-ot <true/t | false/f>`: Corresponds to the same-named option on the schema tool.
- `-ignoreErrors/-i <true/t | false/f>`: Corresponds to the same-named option on the schema tool.
- `-schemas/-s <schema and table names>`: Corresponds to the same-named option on the schema tool. This option is ignored if `readSchema` is not set to `true`.
- `-readSchema/-rs <true/t | false/f>`: Set this option to `true` to read the entire existing schema when the tool runs. Reading the existing schema ensures that OpenJPA does not generate any mappings that use table, index, primary key, or

foreign key names that conflict with existing names. Depending on the JDBC driver, though, it can be a slow process for large schemas.

- `-primaryKeys/-pk <true/t | false/f>`: Whether to read and manipulate primary key information of existing tables. Defaults to false.
- `-foreignKeys/-fk <true/t | false/f>`: Whether to read and manipulate foreign key information of existing tables. Defaults to false. This means that to add any new foreign keys to a class that has already been mapped, you must explicitly set this flag to true.
- `-indexes/-ix <true/t | false/f>`: Whether to read and manipulate index information of existing tables. Defaults to false. This means that to add any new indexes to a class that has already been mapped once, you must explicitly set this flag to true.
- `-sequences/-sq <true/t | false/f>`: Whether to manipulate sequences. Defaults to true.
- `-meta/-m <true/t | false/f>`: Whether the given action applies to metadata rather than or in addition to mappings.

The mapping tool also uses an `-action/-a` argument to specify the action to take on each class. The available actions are:

- `buildSchema`: This is the default action. It makes the database schema match your existing mappings. If your provided mappings conflict with your class definitions, OpenJPA will fail with an informative exception.
- `validate`: Ensure that the mappings for the given classes are valid and that they match the schema. No mappings or tables will be changed. An exception is thrown if any mappings are invalid.

Each additional argument to the tool should be one of:

- The full name of a persistent class.
- The `.java` file for a persistent class.
- The `.class` file of a persistent class.

If you do not supply any arguments to the mapping tool, it will run on the classes in your persistent classes list (see [Section 5.1, “Persistent Class List” \[274\]](#)).

The mappings generated by the mapping tool are stored by the system `mapping factory`. [Section 7.5, “Mapping Factory” \[313\]](#) discusses your mapping factory options.

## 7.1.1. Using the Mapping Tool

The JPA specification defines a comprehensive set of defaults for missing mapping information. Thus, forward mapping in JPA is virtually automatic. After using the mapping annotations covered in [Chapter 13, Mapping Metadata \[147\]](#) of the JPA Overview to override any unsatisfactory defaults, run the mapping tool on your persistent classes. The default `buildSchema` mapping tool action manipulates the database schema to match your mappings. It fails if any of your mappings don't match your object model.

### *Example 7.2. Creating the Relational Schema from Mappings*

```
java org.apache.openjpa.jdbc.meta.MappingTool Magazine.java
```

To drop the schema for a persistent class, set the mapping tool's `schemaAction` to `drop`.

### *Example 7.3. Refreshing entire schema and cleaning out tables*

```
java org.apache.openjpa.jdbc.meta.MappingTool -schemaAction add,deleteTableContents
```

### *Example 7.4. Dropping Mappings and Association Schema*

```
java org.apache.openjpa.jdbc.meta.MappingTool -schemaAction drop Magazine.java
```

## 7.1.2. Generating DDL SQL

The examples below show how to use the mapping tool to generate DDL SQL scripts, rather than modifying the database directly.

### *Example 7.5. Create DDL for Current Mappings*

This example uses your existing mappings to determine the needed schema, then writes the SQL to create that schema to `create.sql`.

```
java org.apache.openjpa.jdbc.meta.MappingTool -schemaAction build -sql create.sql Magazine.java
```

### *Example 7.6. Create DDL to Update Database for Current Mappings*

This example uses your existing mappings to determine the needed schema. It then writes the SQL to add any missing tables and columns to the current schema to `update.sql`.

```
java org.apache.openjpa.jdbc.meta.MappingTool -sql update.sql Magazine.java
```

## 7.1.3. Runtime Forward Mapping

You can configure OpenJPA to automatically run the mapping tool at runtime through the `openjpa.jdbc.SynchronizeMappings` configuration property. Using this property saves you the trouble of running the mapping tool manually, and is meant for use during rapid test/debug cycles.

In order to enable automatic runtime mapping, you must first list all your persistent classes as described in [Section 5.1, “Persistent Class List” \[274\]](#).

OpenJPA will run the mapping tool on these classes when your application obtains its first `EntityManager`.

The `openjpa.jdbc.SynchronizeMappings` property is a plugin string (see [Section 2.4, “Plugin Configuration” \[210\]](#)) where the class name is the mapping tool action to invoke, and the properties are the `MappingTool` class' `JavaBean` properties. These properties correspond go the long versions of the tool's command line flags.

### *Example 7.7. Configuring Runtime Forward Mapping*

```
<property name="openjpa.jdbc.SynchronizeMappings" value="buildSchema(ForeignKeys=true)"/>
```

The setting above corresponds to running the following command:

```
java org.apache.openjpa.jdbc.meta.MappingTool -action buildSchema -foreignKeys true
```

## 7.2. Reverse Mapping

OpenJPA includes a *reverse mapping* tool for generating persistent class definitions, complete with metadata, from an existing database schema. You do not have to use the reverse mapping tool to access an existing schema; you are free to write your classes and mappings yourself, as described in [Section 7.3, “Meet-in-the-Middle Mapping”](#) [311]. The reverse mapping tool, however, can give you an excellent starting point from which to grow your persistent classes.

To use the reverse mapping tool, follow the steps below:

1. Use the **schema tool** to export your current schema to an XML schema file. You can skip this step and the next step if you want to run the reverse mapping tool directly against the database.

### *Example 7.8. Reflection with the Schema Tool*

```
java org.apache.openjpa.jdbc.schema.SchemaTool -a reflect -f schema.xml
```

2. Examine the generated schema file. JDBC drivers often provide incomplete or faulty metadata, in which case the file will not exactly match the actual schema. Alter the XML file to match the true schema. The XML format for the schema file is described in [Section 4.14, “XML Schema Format”](#) [271].

After fixing any errors in the schema file, modify the XML to include foreign keys between all relations. The schema tool will have automatically detected existing foreign key constraints; many schemas, however, do not employ database foreign keys for every relation. By manually adding any missing foreign keys, you will give the reverse mapping tool the information it needs to generate the proper relations between the persistent classes it creates.

3. Run the reverse mapping tool on the finished schema file. If you do not supply the schema file to reverse map, the tool will run directly against the schema in the database. The tool can be run via its Java class, `org.apache.openjpa.jdbc.meta.ReverseMappingTool`.

### *Example 7.9. Using the Reverse Mapping Tool*

```
java org.apache.openjpa.jdbc.meta.ReverseMappingTool -pkg com.xyz -d ~/src -cp customizer.properties schema.xml
```

In addition to OpenJPA's **standard configuration flags**, including **code formatting options**, the reverse mapping tool recognizes the following command line arguments:

- `-schemas/-s <schema and table names>`: A comma-separated list of schema and table names to reverse map, if no XML schema file is supplied. Each element of the list must follow the naming conventions for the `openjpa.jdbc.Schemas` property described in [Section 4.12.1, “Schemas List”](#) [267]. In fact, if this flag is omitted, it defaults to the value of the `Schemas` property. If the `Schemas` property is not defined, all schemas will be reverse-mapped.
- `-package/-pkg <package name>`: The package name of the generated classes. If no package name is given, the generated code will not contain package declarations.

- `-directory/-d <output directory>`: All generated code and metadata will be written to the directory at this path. If the path does not match the package of a class, the package structure will be created beneath this directory. Defaults to the current directory.
- `-metadata/-md <class | package | none>`: Specify the level the metadata should be generated at. Defaults to generating a single package-level metadata file. Set to `none` to disable `orm.xml` generation.
- `-annotations/-ann <true/t | false/f>`: Set to `true` to generate JPA annotations in generated Java classes.
- `-accessType/-access <field | property>`: Change access type for generated annotations. Defaults to `field` access.
- `-useSchemaName/-sn <true/t | false/f>`: Set this flag to `true` to include the schema as well as table name in the name of each generated class. This can be useful when dealing with multiple schemas with same-named tables.
- `-useSchemaElement/-se <true/t | false/f>`: Set this flag to `false` to exclude the schema name from the `@Table` annotation in the generated class for each table. If set to `false`, the schema name will also be removed from the corresponding XML mapping files (`orm.xml`) that are generated by the tool. The initialized value is `true` (in order to preserve backwards compatibility).
- `-useForeignKeyName/-fkn <true/t | false/f>`: Set this flag to `true` if you would like field names for relations to be based on the database foreign key name. By default, relation field names are derived from the name of the related class.
- `-nullableAsObject/-no <true/t | false/f>`: By default, all non-foreign key columns are mapped to primitives. Set this flag to `true` to generate primitive wrapper fields instead for columns that allow null values.
- `-blobAsObject/-bo <true/t | false/f>`: By default, all binary columns are mapped to `byte[]` fields. Set this flag to `true` to map them to `Object` fields instead. Note that when mapped this way, the column is presumed to contain a serialized Java object.
- `-primaryKeyOnJoin/-pkj <true/t | false/f>`: The standard reverse mapping tool behavior is to map all tables with primary keys to persistent classes. If your schema has primary keys on many-many join tables as well, set this flag to `true` to avoid creating classes for those tables.
- `-inverseRelations/-ir <true/t | false/f>`: Set to `false` to prevent the creation of inverse 1-many/1-1 relations for every many-1/1-1 relation detected.
- `-useGenericCollections/-gc <true/t | false/f>`: Set to `true` to use generic collections on `OneToMany` and `ManyToMany` relations.
- `-useDatastoreIdentity/-ds <true/t | false/f>`: Set to `true` to use datastore identity for tables that have single numeric primary key columns. The tool typically uses application identity for all generated classes.
- `-useBuiltinIdentityClass/-bic <true/t | false/f>`: Set to `false` to prevent the tool from using built-in application identity classes when possible. This will force the tool to create custom application identity classes even when there is only one primary key column.
- `-innerIdentityClasses/-inn <true/t | false/f>`: Set to `true` to have any generated application identity classes be created as static inner classes within the persistent classes. Defaults to `false`.
- `-identityClassSuffix/-is <suffix>`: Suffix to append to class names to form application identity class names, or for inner identity classes, the inner class name. Defaults to `Id`.
- `-typeMap/-typ <type mapping>`: A string that specifies the default Java classes to generate for each SQL type that is seen in the schema. The format is `SQLTYPE1=JavaClass1,SQLTYPE2=JavaClass2`. The SQL type name



first looks for a customization based on `SQLTYPE(SIZE,PRECISION)`, then `SQLTYPE(SIZE)`, then `SQLTYPE`. So if a column whose type name is `CHAR` is found, it will first look for the `CHAR(50,0)` type name specification, then it will look for `CHAR(50)`, and finally it will just look for `CHAR`. For example, to generate a char array for every `CHAR` column whose size is exactly 50, and to generate a `short` for every type name of `INTEGER`, you might specify: `CHAR(50)=char[ ], INTEGER=short`. Note that since various databases report different type names differently, one database's type name specification might not work for another database. Enable `TRACE` level logging on the `MetaData` channel to track which type names OpenJPA is examining.

- `-customizerClass/-cc <class name>`: The full class name of a `org.apache.openjpa.jdbc.meta.ReverseCustomizer` customization plugin. If you do not specify a reverse customizer of your own, the system defaults to a `PropertiesReverseCustomizer`. This customizer allows you to specify simple customization options in the properties file given with the `-customizerProperties` flag below. We present the available property keys **below**.
- `-customizerProperties/-cp <properties file or resource>`: The path or resource name of a properties file to pass to the reverse customizer on initialization.
- `-customizer./-c.<property name> <property value>`: The given property name will be matched with the corresponding Java bean property in the specified reverse customizer, and set to the given value.

Running the tool will generate `.java` files for each generated class (and its application identity class, if applicable), along with JPA annotations (if enabled by setting `-annotations true`), or an `orm.xml` file (if not disabled with `-metadata none`) containing the corresponding persistence metadata.

4. Examine the generated class, metadata, and mapping information, and modify it as necessary. Remember that the reverse mapping tool only provides a starting point, and you are free to make whatever modifications you like to the code it generates.

After you are satisfied with the generated classes and their mappings, you should first compile the classes with `javac`, `jikes`, or your favorite Java compiler. Make sure the classes are located in the directory corresponding to the `-package` flag you gave the reverse mapping tool. Next, if you have generated an `orm.xml`, move that file to a `META-INF` directory within a directory in your classpath. Finally, enhance the classes if necessary (see [Section 5.2, “Enhancement” \[274\]](#)).

Your persistent classes are now ready to access your existing schema.

## 7.2.1. Customizing Reverse Mapping

The `org.apache.openjpa.jdbc.meta.ReverseCustomizer` plugin interface allows you to customize the reverse mapping process. See the class [Javadoc](#) for details on the hooks that this interface provides. Specify the concrete plugin implementation to use with the `-customizerClass/-cc` command-line flag, described in the preceding section.

By default, the reverse mapping tool uses a `org.apache.openjpa.jdbc.meta.PropertiesReverseCustomizer`. This customizer allows you to perform relatively simple customizations through the properties file named with the `-customizerProperties` tool flag. The customizer recognizes the following properties:

- `<table name>.table-type <type>`: Override the default type of the table with name `<table name>`. Legal values are:
  - `base`: Primary table for a base class.
  - `secondary`: Secondary table for a class. The table must have a foreign key joining to a class table.
  - `secondary-outer`: Outer-joined secondary table for a class. The table must have a foreign key joining to a class table.
  - `association`: Association table. The table must have two foreign keys to class tables.
  - `collection`: Collection table. The table must have one foreign key to a class table and one data column.

- `subclass`: A joined subclass table. The table must have a foreign key to the superclass' table.
- `none`: The table should not be reverse-mapped.
- `<class name>.rename <new class name>`: Override the given tool-generated name `<class name>` with a new value. Use full class names, including package. You are free to rename a class to a new package. Specify a value of `none` to reject the class and leave the corresponding table unmapped.
- `<table name>.class-name <new class name>`: Assign the given fully-qualified class name to the type created from the table with name `<table name>`. Use a value of `none` to prevent reverse mapping this table. This property can be used in place of the `rename` property.
- `<class name>.identity <datastore | builtin | identity class name>`: Set this property to `datastore` to use datastore identity for the class `<class name>`, `builtin` to use a built-in identity class, or the desired application identity class name. Give full class names, including package. You are free to change the package of the identity class this way. If the persistent class has been renamed, use the new class name for this property key. Remember that `datastore` identity requires a table with a single numeric primary key column, and `built-in` identity requires a single primary key column of any type.
- `<class name>.<field name>.rename <new field name>` : Override the tool-generated `<field name>` in class `<class name>` with the given name. Use the field owner's full class name in the property key. If the field owner's class was renamed, use the new class name. The property value should be the new field name, without the preceding class name. Use a value of `none` to reject the generated mapping and remove the field from the class.
- `<table name>.<column name>.field-name <new field name>`: Set the generated field name for the `<table name>` table's `<column name>` column. If this is a multi-column mapping, any of the columns can be used. Use a value of `none` to prevent the column and its associated columns from being reverse-mapped.
- `<class name>.<field name>.type <field type>` : The type to give the named field. Use full class names. If the field or the field's owner class has been renamed, use the new name.
- `<class name>.<field name>.value`: The initial value for the named field. The given string will be placed as-is in the generated Java code, so be sure it is valid Java. If the field or the field's owner class has been renamed, use the new name.

All property keys are optional; if not specified, the customizer keeps the default value generated by the reverse mapping tool.

### ***Example 7.10. Customizing Reverse Mapping with Properties***

```
java org.apache.openjpa.jdbc.meta.ReverseMappingTool -pkg com.xyz -cp custom.properties schema.xml
```

Example `custom.properties`:

```
com.xyz.TblMagazine.rename:          com.xyz.Magazine
com.xyz.TblArticle.rename:         com.xyz.Article
com.xyz.TblPubCompany.rename:      com.xyz.pub.Company
com.xyz.TblSysInfo.rename:         none

com.xyz.Magazine.allArticles.rename:  articles
com.xyz.Magazine.articles.type:      java.util.Collection
com.xyz.Magazine.articles.value:     new TreeSet()
com.xyz.Magazine.identity:          datastore

com.xyz.pub.Company.identity:       com.xyz.pub.CompanyId
```

## 7.3. Meet-in-the-Middle Mapping

In the *meet-in-the-middle* mapping approach, you control both the relational model and the object model. It is up to you to define the mappings between these models. The mapping tool's `validate` action is useful to meet-in-the-middle mappers. This action verifies that the mapping information for a class matches the class definition and the existing schema. It throws an informative exception when your mappings are incorrect.

### Example 7.11. Validating Mappings

```
java org.apache.openjpa.jdbc.meta.MappingTool -action validate Magazine.java
```

The `buildSchema` action we discussed in [Section 7.1, “Forward Mapping” \[304\]](#) is also somewhat useful during meet-in-the-middle mapping. Unlike the `validate` action, which throws an exception if your mapping data does not match the existing schema, the `buildSchema` action assumes your mapping data is correct, and modifies the schema to match your mappings. This lets you modify your mapping data manually, but saves you the hassle of using your database's tools to bring the schema up-to-date.

## 7.4. Mapping Defaults

The previous sections showed how to use the mapping tool to generate default mappings. But how does the mapping tool know what mappings to generate? The answer lies in the `org.apache.openjpa.jdbc.meta.MappingDefaults` interface. OpenJPA uses an instance of this interface to decide how to name tables and columns, where to put foreign keys, and generally how to create a schema that matches your object model.

### Important

OpenJPA relies on foreign key constraint information at runtime to order SQL appropriately. Be sure to set your mapping defaults to reflect your existing database constraints, set the schema factory to reflect on the database for constraint information (see [Section 4.12.2, “Schema Factory” \[267\]](#)), or use explicit foreign key mappings as described in [Section 7.7.9.2, “Foreign Keys” \[323\]](#).

The `openjpa.jdbc.MappingDefaults` configuration property controls the `MappingDefaults` interface implementation in use. This is a plugin property (see [Section 2.4, “Plugin Configuration” \[210\]](#)), so you can substitute your own implementation or configure the existing ones. OpenJPA includes the following standard implementations:

- `jpa`: Provides defaults in compliance with the JPA standard. This is an alias for the `org.apache.openjpa.persistence.jdbc.PersistenceMappingDefaults` class. This class extends the `MappingDefaultsImpl` class described below, so it has all the same properties (though with different default values), as well as:
  - `PrependFieldNameToJoinTableInverseJoinColumns`: Whether to prepend the owning field name to the names of inverse join columns in join tables. Defaults to true per the JPA specification. Set to false for compatibility with older OpenJPA versions which did not prepend the field name.
- `default`: This is an alias for the `org.apache.openjpa.jdbc.meta.MappingDefaultsImpl` class. This default implementation is highly configurable. It has the following properties:
  - `DefaultMissingInfo`: Whether to default missing column and table names rather than throw an exception. If set to false, full explicit mappings are required at runtime and when using mapping tool actions like `buildSchema` and `validate`.

- `RemoveHungarianNotation`: Switches on/off removal of Hungarian notation when generating column names. Fields such as `mFoobar` and `strBarFoo` would become columns named `foobar` and `barfoo` respectively. OpenJPA will search for the first instance of a uppercase character in the field name and then truncate the column name to remove anything before it.
- `BaseClassStrategy`: The default mapping strategy for base classes. You can specify a built-in strategy alias or the full class name of a **custom class strategy**. You can also use OpenJPA's plugin format (see [Section 2.4, “Plugin Configuration” \[210\]](#)) to pass arguments to the strategy instance. See the `org.apache.openjpa.jdbc.meta.strats` package for available strategies.
- `SubclassStrategy`: The default mapping strategy for subclasses. You can specify a builtin strategy alias or the full class name of a **custom class strategy**. You can also use OpenJPA's plugin format (see [Section 2.4, “Plugin Configuration” \[210\]](#)) to pass arguments to the strategy instance. Common strategies are `vertical` and `flat`, the default. See the `org.apache.openjpa.jdbc.meta.strats` package for all available strategies.
- `VersionStrategy`: The default version strategy for classes without a version field. You can specify a builtin strategy alias or the full class name of a **custom version strategy**. You can also use OpenJPA's plugin format (see [Section 2.4, “Plugin Configuration” \[210\]](#)) to pass arguments to the strategy instance. Common strategies are `none`, `state-comparison`, `timestamp`, and `version-number`, the default. See the `org.apache.openjpa.jdbc.meta.strats` package for all available strategies.
- `DiscriminatorStrategy`: The default discriminator strategy when no discriminator value is given. You can specify a builtin strategy alias or the full class name of a **custom discriminator strategy**. You can also use OpenJPA's plugin format (see [Section 2.4, “Plugin Configuration” \[210\]](#)) to pass arguments to the strategy instance. Common strategies are `final` for a base class without subclasses, `none` to use joins to subclass tables rather than a discriminator column, and `class-name`, the default. See the `org.apache.openjpa.jdbc.meta.strats` package for all available strategies.
- `FieldStrategies`: This property associates field types with custom strategies. The format of this property is similar to that of plugin strings (see [Section 2.4, “Plugin Configuration” \[210\]](#)), without the class name. It is a comma-separated list of key/value pairs, where each key is a possible field type, and each value is itself a plugin string describing the strategy for that type. We present an example below. See [Section 7.10.3, “Custom Field Mapping” \[331\]](#) for information on custom field strategies.
- `ForeignKeyDeleteAction`: The default delete action of foreign keys representing relations to other objects. Recognized values include `restrict`, `cascade`, `null`, `default`. These values correspond exactly to the standard database foreign key actions of the same names.

The value `none` tells OpenJPA not to create database foreign keys on relation columns. This is the default.

- `JoinForeignKeyDeleteAction`: The default delete action of foreign keys that join secondary, collection, map, or subclass tables to the primary table. Accepts the same values as the `ForeignKeyDeleteAction` property above.
- `DeferConstraints`: Whether to use deferred database constraints if possible. Defaults to false.
- `IndexLogicalForeignKeys`: Boolean property controlling whether to create indexes on logical foreign keys. Logical foreign keys are columns that represent a link between tables, but have been configured through the `ForeignKey` properties above not to use a physical database foreign key. Defaults to true.
- `DataStoreIdColumnName`: The default name of datastore identity columns.
- `DiscriminatorColumnName`: The default name of discriminator columns.
- `IndexDiscriminator`: Whether to index the discriminator column. Defaults to true.
- `VersionColumnName`: The default name of version columns.

- `IndexVersion`: Whether to index the version column. Defaults to false.
- `AddNullIndicator`: Whether to create a synthetic null indicator column for embedded mappings. The null indicator column allows OpenJPA to distinguish between a null embedded object and one with default values for all persistent fields.
- `NullIndicatorColumnName`: The default name of synthetic null indicator columns for embedded objects.
- `OrderLists`: Whether to create a database ordering column for maintaining the order of persistent lists and arrays.
- `OrderColumnName`: The default name of collection and array ordering columns.
- `StoreEnumOrdinal`: Set to true to store enum fields as numeric ordinal values in the database. The default is to store the enum value name as a string, which is more robust if the Java enum declaration might be rearranged.
- `StoreUnmappedObjectIdString`: Set to true to store the stringified identity of related objects when the declared related type is unmapped. By default, OpenJPA stores the related object's primary key value(s). However, this breaks down if different subclasses of the related type use incompatible primary key structures. In that case, stringifying the identity value is the better choice.

The example below turns on foreign key generation during schema creation and associates the `org.mag.data.InfoStruct` field type with the custom `org.mag.mapping.InfoStructHandler` value handler.

### *Example 7.12. Configuring Mapping Defaults*

```
<property name="openjpa.jdbc.MappingDefaults"
  value="ForeignKeyDeleteAction=restrict,
  FieldStrategies='org.mag.data.InfoStruct=org.mag.mapping.InfoStructHandler' "/>
```

## 7.5. Mapping Factory

An important decision in the object-relational mapping process is how and where to store the data necessary to map your persistent classes to the database schema.

**Section 6.1, “Metadata Factory” [297]** introduced OpenJPA's `MetaDataFactory` interface. OpenJPA uses this same interface to abstract the storage and retrieval of mapping information. OpenJPA includes the built-in mapping factories below, and you can create your own factory if you have custom needs. You control which mapping factory OpenJPA uses with the `openjpa.jdbc.MappingFactory` configuration property.

The bundled mapping factories are:

- `-`: Leaving the `openjpa.jdbc.MappingFactory` property unset allows your metadata factory to take over mappings as well. If you are using the default `jpa` metadata factory, OpenJPA will read mapping information from your annotations and `orm.xml` when you leave the mapping factory unspecified.

### *Example 7.13. Standard JPA Configuration*

In the standard JPA configuration, the mapping factory is left unset.

```
<property name="openjpa.MetaDataFactory" value="jpa" />
```

## 7.6. Non-Standard Joins

The JPA Overview's [Chapter 13, \*Mapping Metadata\*](#) [147] explains join mapping. All of the examples in that document, however, use "standard" joins, in that there is one foreign key column for each primary key column in the target table. OpenJPA supports additional join patterns, including partial primary key joins, non-primary key joins, and joins using constant values.

In a partial primary key join, the source table only has foreign key columns for a subset of the primary key columns in the target table. So long as this subset of columns correctly identifies the proper row(s) in the referenced table, OpenJPA will function properly. There is no special syntax for expressing a partial primary key join - just do not include column definitions for missing foreign key columns.

In a non-primary key join, at least one of the target columns is not a primary key. Once again, OpenJPA supports this join type with the same syntax as a primary key join. There is one restriction, however: each non-primary key column you are joining to must be controlled by a field mapping that implements the `org.apache.openjpa.jdbc.meta.Joinable` interface. All built in basic mappings implement this interface, including basic fields of embedded objects. OpenJPA will also respect any custom mappings that implement this interface. See [Section 7.10, "Custom Mappings"](#) [330] for an examination of custom mappings.

Not all joins consist of only links between columns. In some cases you might have a schema in which one of the join criteria is that a column in the source or target table must have some constant value. OpenJPA calls joins involving constant values *constant joins*.

To form a constant join in JPA mapping, first set the `JoinColumn`'s `name` attribute to the name of the column. If the column with the constant value is the target of the join, give its fully qualified name in the form `<table name>.<column name>`. Next, set the `referencedColumnName` attribute to the constant value. If the constant value is a string, place it in single quotes to differentiate it from a column name.

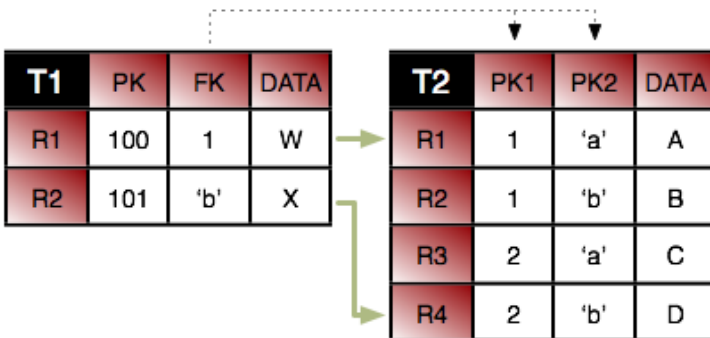

Consider the tables above. First, we want to join row `T1.R1` to row `T2.R1`. If we just join column `T1.FK` to `T2.PK1`, we will wind up matching both `T2.R1` and `T2.R2`. So in addition to joining `T1.FK` to `T2.PK1`, we also have to specify that `T2.PK2` has the value `a`. Here is how we'd accomplish this in mapping metadata.

```
@Entity
@Table(name="T1")
public class ... {

    @ManyToOne
    @JoinColumns({
        @JoinColumn(name="FK" referencedColumnName="PK1"),
        @JoinColumn(name="T2.PK2" referencedColumnName="'a'")
    });
    private ...;
}
```

Notice that we had to fully qualify the name of column PK2 because it is in the target table. Also notice that we put single quotes around the constant value so that it won't be confused with a column name. You do not need single quotes for numeric constants. For example, the syntax to join T1.R2 to T2.R4 is:

```
@Entity
@Table(name="T1")
public class ... {

    @ManyToOne
    @JoinColumns({
        @JoinColumn(name="FK" referencedColumnName="PK2"),
        @JoinColumn(name="T2.PK1" referencedColumnName="2")
    });
    private ...;
}
```

Finally, from the inverse direction, these joins would look like this:

```
@Entity
@Table(name="T2")
public class ... {

    @ManyToOne
    @JoinColumns({
        @JoinColumn(name="T1.FK" referencedColumnName="PK1"),
        @JoinColumn(name="PK2" referencedColumnName="'a'")
    });
    private ...;

    @ManyToOne
    @JoinColumns({
        @JoinColumn(name="T1.FK" referencedColumnName="PK2"),
        @JoinColumn(name="PK1" referencedColumnName="2")
    });
    private ...;
}
```

## 7.7. Additional JPA Mappings

OpenJPA supports many persistence strategies beyond those of the JPA specification. [Section 6.3, “Additional JPA Metadata” \[298\]](#) covered the logical metadata for OpenJPA's additional persistence strategies. We now demonstrate how to map entities using these strategies to the database.

### 7.7.1. Datastore Identity Mapping

[Section 5.4, “Object Identity” \[279\]](#) describes how to use datastore identity in JPA.

OpenJPA requires a single numeric primary key column to hold datastore identity values. The `org.apache.openjpa.persistence.jdbc.DataStoreIdColumn` annotation customizes the datastore identity column. This annotation has the following properties:

- String name: Defaults to ID.
- int precision
- String columnDefinition
- boolean insertable

- boolean updatable

All properties correspond exactly to the same-named properties on the standard `Column` annotation, described in [Section 13.3, “Column” \[151\]](#).

### *Example 7.14. Datastore Identity Mapping*

```
import org.apache.openjpa.persistence.*;
import org.apache.openjpa.persistence.jdbc.*;

@Entity
@Table(name="LOGS")
@DatastoreIdColumn(name="ENTRY")
public class LogEntry {

    @Lob
    private String content;

    ...
}
```

## 7.7.2. Surrogate Version Mapping

OpenJPA supports version fields as defined by the JPA specification, but allows you to use a surrogate version column in place of a version field if you like. You map the surrogate version column with the `org.apache.openjpa.persistence.jdbc.VersionColumn` annotation. You can also use the `org.apache.openjpa.persistence.jdbc.VersionColumns` annotation to declare an array of `VersionColumn` values. Each `VersionColumn` has the following properties:

- String name: Defaults to `VERSN`.
- String table
- int length
- int precision
- int scale
- String columnDefinition
- boolean nullable
- boolean insertable
- boolean updatable

All properties correspond exactly to the same-named properties on the standard `Column` annotation, described in [Section 13.3, “Column” \[151\]](#).

By default, OpenJPA assumes that surrogate versioning uses a version number strategy. You can choose a different strategy with the `VersionStrategy` annotation described in [Section 7.9.1.4, “Version Strategy” \[329\]](#).

If multiple columns are used for surrogate versioning, then each column, by default, uses a version number. But column definition for each version column can be set independently to other numeric types. The version values are compared to detect optimistic concurrent modification. Such comparison must determine whether a version value `v1` represents an earlier, later or



same with respect to another version value  $v_2$ . While result of such comparison is obvious for a single numeric column that monotonically increases on each update, the same is not true when version value is an array of numbers. By default, OpenJPA compares a version  $v_1$  as later than another version  $v_2$ , if any array element of  $v_1$  is later than the corresponding element of  $v_2$ .  $v_1$  is equal to  $v_2$  if every array element is equal and  $v_1$  is earlier to  $v_2$  if some elements of  $v_1$  are earlier and rest are equal to corresponding element of  $v_2$ .

Multiple surrogate version columns can be spread across primary and secondary tables. For example, following example shows 3 version columns  $v_{01}$ ,  $v_{11}$ ,  $v_{12}$ ,  $v_{21}$  defined across the primary and secondary tables of a persistent entity

```
@Entity
@Table(name="PRIMARY")
@SecondaryTables({
    @SecondaryTable(name = "SECONDARY_1"),
    @SecondaryTable(name = "SECONDARY_2")
})
@VersionStrategy("version-numbers")
@VersionColumns({
    @VersionColumn(name = "v01") // default is the PRIMARY table
    @VersionColumn(name = "v11", table="SECONDARY_1", columnDefinition="FLOAT", scale=3, precision=10),
    @VersionColumn(name = "v12", table="SECONDARY_1"),
    @VersionColumn(name = "v21", table="SECONDARY_2"),
})
```

### 7.7.3. Multi-Column Mappings

OpenJPA makes it easy to create multi-column **custom mappings**. The JPA specification includes a `Column` annotation, but is missing a way to declare multiple columns for a single field. OpenJPA remedies this with the `org.apache.openjpa.persistence.jdbc.Columns` annotation, which contains an array of `Column` values.

Remember to annotate custom field types with `Persistent`, as described in [Section 6.3.3, “Persistent Field Values” \[298\]](#).

### 7.7.4. Join Column Attribute Targets

[Section 13.8.4, “Direct Relations” \[181\]](#) in the JPA Overview introduced you to the `JoinColumn` annotation. A `JoinColumn`'s `referencedColumnName` property declares which column in the table of the related type this join column links to. Suppose, however, that the related type is unmapped, or that it is part of a table-per-class inheritance hierarchy. Each subclass that might be assigned to the field could reside in a different table, and could use entirely different names for its primary key columns. It becomes impossible to supply a single `referencedColumnName` that works for all subclasses.

OpenJPA rectifies this by allowing you to declare which *attribute* in the related type each join column links to, rather than which column. If the attribute is mapped differently in various subclass tables, OpenJPA automatically forms the proper join for the subclass record at hand. The `org.apache.openjpa.persistence.jdbc.XJoinColumn` annotation has all the same properties as the standard `JoinColumn` annotation, but adds an additional `referencedAttributeName` property for this purpose. Simply use a `XJoinColumn` in place of a `JoinColumn` whenever you need to access this added functionality.

For compound keys, use the `org.apache.openjpa.persistence.jdbc.XJoinColumns` annotation. The value of this annotation is an array of individual `XJoinColumns`.

### 7.7.5. Embedded Mapping

JPA uses the `AttributeOverride` annotation to override the default mappings of an embeddable class. The JPA Overview details this process in [Section 13.8.3, “Embedded Mapping” \[179\]](#). `AttributeOverrides` suffice for simple mappings, but do not allow you to override complex mappings. Also, JPA has no way to differentiate between a null embedded object and one with default values for all of its fields.

OpenJPA overcomes these shortcomings with the `org.apache.openjpa.persistence.jdbc.EmbeddedMapping` annotation. This annotation has the following properties:

- `String nullIndicatorColumnName`: If the named column's value is NULL, then the embedded object is assumed to be null. If the named column has a non-NULL value, then the embedded object will get loaded and populated with data from the other embedded fields. This property is entirely optional. By default, OpenJPA always assumes the embedded object is non-null, just as in standard JPA mapping.

If the column you name does not belong to any fields of the embedded object, OpenJPA will create a synthetic null-indicator column with this name. In fact, you can specify a value of `true` to simply indicate that you want a synthetic null-indicator column, without having to come up with a name for it. A value of `false` signals that you explicitly do not want a null-indicator column created for this mapping (in case you have configured your **mapping defaults** to create one by default).

- `String nullIndicatorFieldName`: Rather than name a null indicator column, you can name a field of the embedded type. OpenJPA will use the column of this field as the null-indicator column.
- `MappingOverride[] overrides`: This array allows you to override any mapping of the embedded object.

The `EmbeddedMapping`'s `overrides` array serves the same purpose as standard JPA's `AttributeOverride`s and `AssociationOverride`s. In fact, you can also use the `MappingOverride` annotation on an entity class to override a complex mapping of its mapped superclass, just as you can with `AttributeOverride` and `AssociationOverride`s. The `MappingOverrides` annotation, whose value is an array of `MappingOverride`s, allows you to override multiple mapped superclass mappings.

Each `org.apache.openjpa.persistence.jdbc.MappingOverride` annotation has the following properties:

- `String name`: The name of the field that is being overridden.
- `Column[] columns`: Columns for the new field mapping.
- `XJoinColumn[] joinColumns`: Join columns for the new field mapping, if it is a relation field.
- `ContainerTable containerTable`: Table for the new collection or map field mapping. We cover collection mappings in **Section 7.7.6, “Collections” [319]**, and map mappings in **Section 7.7.8, “Maps” [321]**.
- `ElementJoinColumn[] elementJoinColumns`: Element join columns for the new collection or map field mapping. You will see how to use element join columns in **Section 7.7.6.2, “Element Join Columns” [319]**.

The following example defines an embeddable `PathCoordinate` class with a custom mapping of a `java.awt.Point` field to two columns. It then defines an entity which embeds a `PointCoordinate` and overrides the default mapping for the point field. The entity also declares that if the `PathCoordinate`'s `siteName` field column is null, it means that no `PathCoordinate` is stored in the embedded record; the owning field will load as null.

### *Example 7.15. Overriding Complex Mappings*

```
import org.apache.openjpa.persistence.jdbc.*;

@Embeddable
public class PathCoordinate {

    private String siteName;

    @Persistent
    @Strategy("com.xyz.openjpa.PointValueHandler")
    private Point point;

    ...
}
```

```

@Entity
public class Path {

    @Embedded
    @EmbeddedMapping(nullIndicatorFieldName="siteName", overrides={
        @MappingOverride(name="siteName", columns=@Column(name="START_SITE")),
        @MappingOverride(name="point", columns={
            @Column(name="START_X"),
            @Column(name="START_Y")
        })
    })
    private PathCoordinate start;

    ...
}

```

## 7.7.6. Collections

In [Section 6.3.4, “Persistent Collection Fields” \[299\]](#), we explored the `PersistentCollection` annotation for persistent collection fields that aren't a standard `OneToMany` or `ManyToMany` relation. To map these non-standard collections, combine OpenJPA's `ContainerTable` annotation with `ElementJoinColumns`. We explore the annotations below.

### 7.7.6.1. Container Table

The `org.apache.openjpa.persistence.jdbc.ContainerTable` annotation describes a database table that holds collection (or map) elements. This annotation has the following properties:

- String name
- String catalog
- String schema
- `XJoinColumn[] joinColumns`
- `ForeignKey joinForeignKey`
- `Index joinIndex`

The `name`, `catalog`, `schema`, and `joinColumns` properties describe the container table and how it joins to the owning entity's table. These properties correspond to the same-named properties on the standard `JoinTable` annotation, described in [Section 13.8.5, “Join Table” \[184\]](#). If left unspecified, the name of the table defaults to the first five characters of the entity table name, plus an underscore, plus the field name. The `joinForeignKey` and `joinIndex` properties override default foreign key and index generation for the join columns. We explore foreign keys and indexes later in this chapter.

You may notice that the container table does not define how to store the collection elements. That is left to separate annotations, which are the subject of the next sections.

### 7.7.6.2. Element Join Columns

Element join columns are equivalent to standard JPA join columns, except that they represent a join to a collection or map element entity rather than a direct relation. You represent an element join column with OpenJPA's `org.apache.openjpa.persistence.jdbc.ElementJoinColumn` annotation. To declare a compound join, enclose an array of `ElementJoinColumns` in the `org.apache.openjpa.persistence.jdbc.ElementJoinColumns` annotation.

An `ElementJoinColumn` always resides in a container table, so it does not have the `table` property of a standard `JoinColumn`. Like `XJoinColumns` above, `ElementJoinColumns` can reference a linked attribute rather than a

static linked column. Otherwise, the `ElementJoinColumn` and standard `JoinColumn` annotations are equivalent. See [Section 13.8.4, “Direct Relations” \[181\]](#) in the JPA Overview for a review of the `JoinColumn` annotation.

### 7.7.6.3. Order Column

Relational databases do not guarantee that records are returned in insertion order. If you want to make sure that your collection elements are loaded in the same order they were in when last stored, you must declare an order column. An order column can be declared using OpenJPA's `org.apache.openjpa.persistence.jdbc.OrderColumn` annotation or the JPA 2.0 `javax.persistence.OrderColumn` annotation or `order-column` orm element as defined in [Section 5.3, “XML Schema” \[42\]](#). OpenJPA's `org.apache.openjpa.persistence.jdbc.OrderColumn` annotation has the following properties:

- String `name`: Defaults to the name of the relationship property or field of the entity or embeddable class + `_ORDER`. To use the JPA 1.0 default order column name `ORDER`, set the [Section 2.5.7, “openjpa.Compatibility” \[213\]](#) option `UseJPA2DefaultOrderColumnName` to `false`.
- boolean `enabled`
- int `precision`
- String `columnDefinition`
- boolean `insertable`
- boolean `updatable`

Order columns are always in the container table. You can explicitly turn off ordering (if you have enabled it by default via your **mapping defaults**) by setting the `enabled` property to `false`. All other properties correspond exactly to the same-named properties on the standard `Column` annotation, described in [Section 13.3, “Column” \[151\]](#).

### 7.7.7. One-Sided One-Many Mapping

The previous section covered the use of `ElementJoinColumn` annotations in conjunction with a `ContainerTable` for mapping collections to dedicate tables. `ElementJoinColumns`, however, have one additional use: to create a one-sided one-many mapping. Standard JPA supports `OneToMany` fields without a `mappedBy` inverse, but only by mapping these fields to a `JoinTable` (see [Section 13.8.5, “Join Table” \[184\]](#) in the JPA Overview for details). Often, you'd like to create a one-many association based on an inverse foreign key (logical or actual) in the table of the related type.

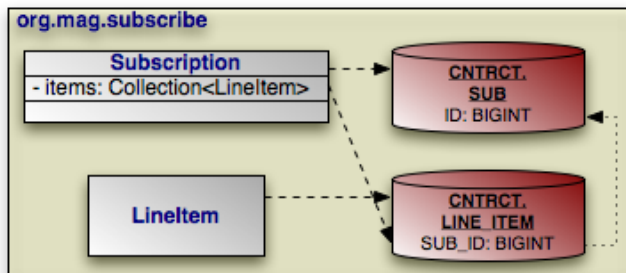

Consider the model above. `Subscription` has a collection of `LineItem`s, but `LineItem` has no inverse relation to `Subscription`. To retrieve all of the `LineItem` records for a `Subscription`, we join the `SUB_ID` inverse foreign key column in the `LINE_ITEM` table to the primary key column of the `SUB` table. The example below shows how to represent this model in mapping annotations. Note that OpenJPA automatically assumes an inverse foreign key mapping when element join columns are given, but no container or join table is given.

**Example 7.16. One-Sided One-Many Mapping**

```

package org.mag.subscribe;

import org.apache.openjpa.persistence.jdbc.*;

@Entity
@Table(name="LINE_ITEM", schema="CNTRCT")
public class LineItem {
    ...
}

@Entity
@Table(name="SUB", schema="CNTRCT")
public class Subscription {

    @Id private long id;

    @OneToMany
    @ElementJoinColumn(name="SUB_ID", referencedColumnName="ID")
    private Collection<LineItem> items;

    ...
}

```

## 7.7.8. Maps

We detailed the `ContainerTable` annotation in [Section 7.7.6.1, “Container Table” \[319\]](#). Custom map mappings may also use this annotation to represent a map table.

### 7.7.8.1. Key Columns

Key columns serve the same role for map keys as the element join columns described in [Section 7.7.6.2, “Element Join Columns” \[319\]](#) serve for collection elements. OpenJPA's `org.apache.openjpa.persistence.jdbc.KeyColumn` annotation represents a map key. To map custom multi-column keys, use the `org.apache.openjpa.persistence.jdbc.KeyColumns` annotation, whose value is an array of `KeyColumns`.

A `KeyColumn` always resides in a container table, so it does not have the `table` property of a standard `Column`. Otherwise, the `KeyColumn` and standard `Column` annotations are equivalent. See [Section 13.3, “Column” \[151\]](#) in the JPA Overview for a review of the `Column` annotation.

### 7.7.8.2. Key Join Columns

Key join columns are equivalent to standard JPA join columns, except that they represent a join to a map key entity rather than a direct relation. You represent a key join column with OpenJPA's `org.apache.openjpa.persistence.jdbc.KeyJoinColumn` annotation. To declare a compound join, enclose an array of `KeyJoinColumns` in the `org.apache.openjpa.persistence.jdbc.KeyJoinColumns` annotation.

A `KeyJoinColumn` always resides in a container table, so it does not have the `table` property of a standard `JoinColumn`. Like `XJoinColumns` above, `KeyJoinColumns` can reference a linked field rather than a static linked column. Otherwise, the `KeyJoinColumn` and standard `JoinColumn` annotations are equivalent. See [Section 13.8.4, “Direct Relations” \[181\]](#) in the JPA Overview for a review of the `JoinColumn` annotation.

### 7.7.8.3. Key Embedded Mapping

The `org.apache.openjpa.persistence.jdbc.KeyEmbeddedMapping` annotation allows you to map your map field's embedded key type to your container table. This annotation has exactly the same properties as the `EmbeddedMapping` annotation described [above](#).

## 7.7.8.4. Examples

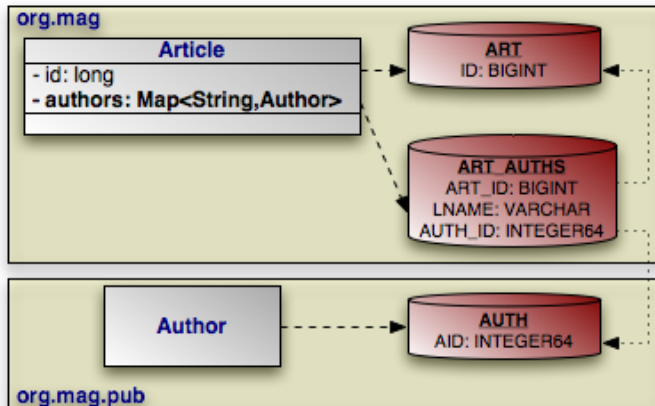

Map mapping in OpenJPA uses the same principles you saw in collection mapping. The example below maps the `Article.authors` map according to the diagram above.

### Example 7.17. String Key, Entity Value Map Mapping

```
package org.mag.pub;

import org.apache.openjpa.persistence.*;
import org.apache.openjpa.persistence.jdbc.*;

@Entity
@Table(name="AUTH")
@DataStoreIdColumn(name="AID", columnDefinition="INTEGER64")
public class Author {
    ...
}

package org.mag;

@Entity
@Table(name="ART")
public class Article {
    @Id private long id;

    @PersistentMap
    @ContainerTable(name="ART_AUTHS", joinColumns=@XJoinColumn(name="ART_ID"))
    @KeyColumn(name="LNAME")
    @ElementJoinColumn(name="AUTH_ID")
    private Map<String, Author> authors;

    ...
}
```

## 7.7.9. Indexes and Constraints

OpenJPA uses index information during schema generation to index the proper columns. OpenJPA uses foreign key and unique constraint information during schema creation to generate the proper database constraints, and also at runtime to order SQL statements to avoid constraint violations while maximizing SQL batch size.

OpenJPA assumes certain columns have indexes or constraints based on your mapping defaults, as detailed in [Section 7.4, “Mapping Defaults”](#) [311]. You can override the configured defaults on individual joins, field values, collection elements, map keys, or map values using the annotations presented in the following sections.

### 7.7.9.1. Indexes

---

The `org.apache.openjpa.persistence.jdbc.Index` annotation represents an index on the columns of a field. It is also used within the `ContainerTable` annotation to index join columns. To index the columns of a collection element, use the `org.apache.openjpa.persistence.jdbc.ElementIndex` annotation. These annotations have the following properties:

- `boolean enabled`: Set this property to `false` to explicitly tell OpenJPA not to index these columns, when OpenJPA would otherwise do so.
- `String name`: The name of the index. OpenJPA will choose a name if you do not provide one.
- `boolean unique`: Whether to create a unique index. Defaults to `false`.

### 7.7.9.2. Foreign Keys

---

The `org.apache.openjpa.persistence.jdbc.ForeignKey` annotation represents a foreign key on the columns of a field. It is also used within the `ContainerTable` annotation to set a database foreign key on join columns. To set a constraint to the columns of a collection element, use the `org.apache.openjpa.persistence.jdbc.ElementForeignKey` annotation. These annotations have the following properties:

- `boolean enabled`: Set this property to `false` to explicitly tell OpenJPA not to set a foreign key on these columns, when OpenJPA would otherwise do so.
- `String name`: The name of the foreign key. OpenJPA will choose a name if you do not provide one, or will create an anonymous key.
- `boolean deferred`: Whether to create a deferred key if supported by the database.
- `boolean implicit`: Whether to mark a relation field value as implicitly referring to a related entity. This property can be used, for example, when a field value represents primary key field of a related entity, but for legacy or other logistic reasons, the field is declared as the same type of the primary key of the related entity instead of a reference to the entity itself. Hence no actual mapping can be defined on the field itself. If this implicit property is set, then no other property on the `ForeignKey` annotation can be set to their non-default value. This setting does not manifest as a database foreign key constraint.
- `ForeignKeyAction deleteAction`: Value from the `org.apache.openjpa.persistence.jdbc.ForeignKeyAction` enum identifying the desired delete action. Defaults to `RESTRICT`.
- `ForeignKeyAction updateAction`: Value from the `org.apache.openjpa.persistence.jdbc.ForeignKeyAction` enum identifying the desired update action. Defaults to `RESTRICT`.

Keep in mind that OpenJPA uses foreign key information at runtime to avoid constraint violations; it is important, therefore, that your **mapping defaults** and foreign key annotations combine to accurately reflect your existing database constraints, or that you configure OpenJPA to reflect on your database schema to discover existing foreign keys (see [Section 4.12.2, “Schema Factory”](#) [267]).

### 7.7.9.3. Unique Constraints

---

The `org.apache.openjpa.persistence.jdbc.Unique` annotation represents a unique constraint on the columns of a field. It is more convenient than using the `uniqueConstraints` property of standard JPA `Table` and `SecondaryTable` annotations, because you can apply it directly to the constrained field. The `Unique` annotation has the following properties:

- `boolean enabled`: Set this property to `false` to explicitly tell OpenJPA not to constrain these columns, when OpenJPA would otherwise do so.

- `String name`: The name of the constraint. OpenJPA will choose a name if you do not provide one, or will create an anonymous constraint.
- `boolean deferred`: Whether to create a deferred constraint if supported by the database.

## 7.7.10. XML Column Mapping

Some databases support XML column types and XPath queries and indexes over these columns. OpenJPA supports mapping of an entity property mapped to an XML column on the following databases and their minimum versions.

- DB2 9
- MySQL 5.1.30
- Oracle 9
- PostgreSQL 8.3 (XML support must be compiled in, the minimum JDBC driver version is 8.3-603)
- SQL Server 2005

See [Appendix 2, \*Supported Databases\* \[394\]](#) for possible database-specific restrictions.

Annotate the entity property using the XMLValueHandler strategy:

```
@Persistent
@Strategy("org.apache.openjpa.jdbc.meta.strats.XMLValueHandler")
```

The default fetch type is EAGER but can be changed to LAZY by using:

```
@Persistence(fetch=FetchType.LAZY)
```

The entity property class is required to have JAXB binding annotations. You can generate property class from an XML schema by using the `xjc` generator from the **JAXB reference implementation**. The `xjc` will generate the class along with the required annotations. Ensure that `@XmlRootElement` appears in the root class. In some cases this annotation needs to be added manually.

The entity property class is required to have getter and setter methods for all its fields. By default, the `xjc` will not generate setter methods for collections but you can force it to do so by using the **setters plugin** or collection setter injector plugin.

The JAXB jar files must be on the application classpath (`jaxb-api.jar`, `jaxb-impl.jar`, `jsr173_1.0_api.jar` or equivalent).

JPQL path expressions can navigate into the mapped class and its subfields to any level.

The path expression is rewritten into an equivalent XPath expression using SQL XML functions.

The path expression must be single-valued. Path expressions over XML mapped classes can only be used in the WHERE clause as an operand to a simple predicate (`= <> <> >= <=`).

Path expressions over XML mapped fields can not be:

- an input to a JPQL scalar function
- an operand of BETWEEN, IS NULL, LIKE or IN predicate
- used to project out subfields in the SELECT clause



- used in the FROM, GROUP BY, HAVING, ORDER BY clauses

XML schema must not contain namespace declarations. The JPQL path expressions can not refer to Java fields generated from XML ANY type or XML mixed element types.

The data type generated by JAXB must be a valid type to use the property in a JPQL predicate.

Shown below is a sample XML schema **myaddress.xsd**, in which the JPA entity Order has `shipAddress` persistent field that maps to an XML column.

### Example 7.18. *myaddress.xsd*

```
<?xml version="1.0" ?>
<xs:schema xmlns:xs="http://www.w3.org/2001/XMLSchema" >

<xs:complexType name="Address">
  <xs:sequence>
    <xs:element name="Name" type="xs:string" />
    <xs:element name="Street" type="xs:string"
      minOccurs="1" maxOccurs="3" />
    <xs:element name="City" type="xs:string" />
  </xs:sequence>
</xs:complexType>

<xs:complexType name="CAN_Address">
  <xs:complexContent>
    <xs:extension base="Address">
      <xs:sequence>
        <xs:element name="Province" type="xs:string" />
        <xs:element name="PostalCode" type="xs:string" />
      </xs:sequence>
    </xs:extension>
  </xs:complexContent>
</xs:complexType>

<xs:simpleType name="USPS_ZIP">
  <xs:restriction base="xs:integer">
    <xs:minInclusive value="01000" />
    <xs:maxInclusive value="99999" />
  </xs:restriction>
</xs:simpleType>

<xs:complexType name="USA_Address">
  <xs:complexContent>
    <xs:extension base="Address">
      <xs:sequence>
        <xs:element name="State" type="xs:string" />
        <xs:element name="ZIP" type="USPS_ZIP" />
      </xs:sequence>
    </xs:extension>
  </xs:complexContent>
</xs:complexType>

<xs:element name="MailAddress" type="Address" />
<xs:element name="AddrCAN" type="CAN_Address"
  substitutionGroup="MailAddress" />
<xs:element name="AddrUSA" type="USA_Address"
  substitutionGroup="MailAddress" />
</xs:schema>
```

Java classes **Address**, **USAAddress** and **CANAddress** are produced from `myaddress` schema by using the `xjc` generator.

### Example 7.19. *Address.java*

```
...
@XmlRootElement
```

```

@XmlAccessorType(XmlAccessType.FIELD)
@XmlType(name = "Address", propOrder = {
    "name",
    "street",
    "city"
})
public class Address {
    @XmlElement(name = "Name", required = true)
    protected String name;
    @XmlElement(name = "Street", required = true)
    protected List<String> street;
    @XmlElement(name = "City", required = true)
    protected String city;

    /**
     * Getter and Setter methods.
     *
     */
    ...
}

```

### ***Example 7.20. USAAddress.java***

```

...
@XmlRootElement
@XmlAccessorType(XmlAccessType.FIELD)
@XmlType(name = "USA_Address", propOrder = {
    "state",
    "zip"
})
public class USAAddress
    extends Address
{
    @XmlElement(name = "State")
    protected String state;
    @XmlElement(name = "ZIP")
    protected int zip;

    /**
     * Getter and Setter methods.
     *
     */
    ...
}

```

### ***Example 7.21. CANAddress.java***

```

...
@XmlRootElement
@XmlAccessorType(XmlAccessType.FIELD)
@XmlType(name = "CAN_Address", propOrder = {
    "province",
    "postalCode"
})
public class CANAddress
    extends Address
{
    @XmlElement(name = "Province")
    protected String province;
    @XmlElement(name = "PostalCode")
    protected String postalCode;

    /**
     * Getter and Setter methods.
     *
     */
}

```

```

    */
    ...
}

```

**Example 7.22. Showing annotated Order entity with XML mapping strategy**

```

@Entity
public class Order {
    @Id private int id;
    @Persistent
    @Strategy ("org.apache.openjpa.jdbc.meta.strats.XMLValueHandler")
    private Address shipAddress;
    ...
}

```

**Example 7.23. Showing creation of Order entity having shipAddress mapped to XML column**

```

...
myaddress.ObjectFactory addressFactory = new myaddress.ObjectFactory();
Customer c1 = new Customer();
c1.setCid( new Customer.CustomerKey("USA", 1) );
c1.setName("Harry's Auto");
Order o1 = new Order( 850, false, c1);
USAAddress addr1 = addressFactory.createUSAAddress();
addr1.setCity("San Jose");
addr1.setState("CA");
addr1.setZIP(new Integer("95141"));
addr1.getStreet().add("12500 Monterey");
addr1.setName( c1.getName());
o1.setShipAddress(addr1);
em.persist(o1);
...

```

**Example 7.24. Sample JPQL queries for XML column mapping**

```

. select o from Order o where o.shipAddress.city = "San Jose" or
    o.shipAddress.city = "San Francisco" (OK)

. select o.shipAddress from Order o (OK)

. select o.shipAddress.city from Order o (INVALID)

. select o from Order o where o.shipAddress.street = "San Jose" (INVALID multi-valued)

```

## 7.7.11. LOB Streaming

In addition to handling LOBs in a standard JPA manner (LOB annotation and `lob` XML element), OpenJPA supports LOB streaming. This feature makes it possible to stream large amounts of data into and out of persistent field without ever holding all the data in memory at the same time.

LOB streaming is supported on the following databases.

- MySQL
- Oracle

- PostgreSQL
- SQL Server
- DB2

See [Appendix 2, \*Supported Databases\*](#) [394] for possible database-specific restrictions.

To persist a stream, apply the `org.apache.openjpa.persistence.Persistent` annotation to either `java.io.InputStream` or `java.io.Reader` field.

### *Example 7.25. Annotated InputStream and Reader*

```
@Entity
public class Employee {
    ...
    @Persistent
    private InputStream photoStream;

    @Persistent
    private Reader photoDescription;
    ...
}
```

## 7.8. Mapping Limitations

The following sections outline the limitations OpenJPA places on specific mapping strategies.

### 7.8.1. Table Per Class

Table-per-class inheritance mapping has the following limitations:

- You cannot traverse polymorphic relations to non-leaf classes in a table-per-class inheritance hierarchy in queries.
- You cannot map a one-sided polymorphic relation to a non-leaf class in a table-per-class inheritance hierarchy using an inverse foreign key.
- You cannot use an order column in a polymorphic relation to a non-leaf class in a table-per-class inheritance hierarchy mapped with an inverse foreign key.
- Table-per-class hierarchies impose limitations on eager fetching. See [Section 5.8.2, “Eager Fetching Considerations and Limitations”](#) [296].

#### Note

Non-polymorphic relations do not suffer from these limitations. You can declare a non-polymorphic relation using the extensions described in [Section 7.9.2.2, “Nonpolymorphic”](#) [329].

## 7.9. Mapping Extensions

Mapping extensions allow you to access OpenJPA-specific functionality from your mappings. Note that all extensions below are specific to mappings. If you store your mappings separately from your persistence metadata, these extensions must be specified along with the mapping information, not the persistence metadata information.

---

## 7.9.1. Class Extensions

---

OpenJPA recognizes the following class extensions.

### 7.9.1.1. Subclass Fetch Mode

---

This extension specifies how to eagerly fetch subclass state. It overrides the global `openjpa.jdbc.SubclassFetchMode` property. Set the OpenJPA `org.apache.openjpa.persistence.jdbc.SubclassFetchMode` annotation to a value from the `org.apache.openjpa.persistence.jdbc.FetchMode` enum: JOIN, PARALLEL, or NONE. See [Section 5.8, “Eager Fetching” \[294\]](#) for a discussion of eager fetching.

### 7.9.1.2. Strategy

---

The `org.apache.openjpa.persistence.jdbc.Strategy` class annotation allows you to specify a custom mapping strategy for your class. See [Section 7.10, “Custom Mappings” \[330\]](#) for information on custom mappings.

### 7.9.1.3. Discriminator Strategy

---

The `org.apache.openjpa.persistence.jdbc.DiscriminatorStrategy` class annotation allows you to specify a custom discriminator strategy. See [Section 7.10, “Custom Mappings” \[330\]](#) for information on custom mappings.

### 7.9.1.4. Version Strategy

---

The `org.apache.openjpa.persistence.jdbc.VersionStrategy` class annotation allows you to specify a custom version strategy. See [Section 7.10, “Custom Mappings” \[330\]](#) for information on custom mappings.

---

## 7.9.2. Field Extensions

---

OpenJPA recognizes the following field extensions.

### 7.9.2.1. Eager Fetch Mode

---

This extension specifies how to eagerly fetch related objects. It overrides the global `openjpa.jdbc.EagerFetchMode` property. Set the OpenJPA `org.apache.openjpa.persistence.jdbc.EagerFetchMode` annotation to a value from the `org.apache.openjpa.persistence.jdbc.FetchMode` enum: JOIN, PARALLEL, or NONE. See [Section 5.8, “Eager Fetching” \[294\]](#) for a discussion of eager fetching.

### 7.9.2.2. Nonpolymorphic

---

All fields in Java are polymorphic. If you declare a field of type `T`, you can assign any subclass of `T` to the field as well. This is very convenient, but can make relation traversal very inefficient under some inheritance strategies. It can even make querying across the field impossible. Often, you know that certain fields do not need to be entirely polymorphic. By telling OpenJPA about such fields, you can improve the efficiency of your relations.

#### Note

OpenJPA also includes the `type` metadata extension for narrowing the declared type of a field. See [Section 6.4.2.6, “Type” \[301\]](#).

OpenJPA defines the following extensions for nonpolymorphic values:

- `org.apache.openjpa.persistence.jdbc.Nonpolymorphic`

- `org.apache.openjpa.persistence.jdbc.ElementNonpolymorphic`

The value of these extensions is a constant from the

`org.apache.openjpa.persistence.jdbc.NonpolymorphicType` enumeration. The default value, `EXACT`, indicates that the relation will always be of the exact declared type. A value of `JOINABLE`, on the other hand, means that the relation might be to any joinable subclass of the declared type. This value only excludes table-per-class subclasses.

### 7.9.2.3. Class Criteria

This family of boolean extensions determines whether OpenJPA will use the expected class of related objects as criteria in the SQL it issues to load a relation field. Typically, this is not needed. The foreign key values uniquely identify the record for the related object. Under some rare mappings, however, you may need to consider both foreign key values and the expected class of the related object - for example, if you have an inverse relation that shares the foreign key with another inverse relation to an object of a different subclass. In these cases, set the proper class criteria extension to `true` to force OpenJPA to append class criteria to its select SQL.

OpenJPA defines the following class criteria annotations for field relations and array or collection element relations, respectively:

- `org.apache.openjpa.persistence.jdbc.ClassCriteria`
- `org.apache.openjpa.persistence.jdbc.ElementClassCriteria`

### 7.9.2.4. Strategy

OpenJPA's `org.apache.openjpa.persistence.jdbc.Strategy` extension allows you to specify a custom mapping strategy or value handler for a field. See [Section 7.10, “Custom Mappings”](#) [330] for information on custom mappings.

## 7.10. Custom Mappings

In OpenJPA, you are not limited to the set of standard mappings defined by the specification. OpenJPA allows you to define custom class, discriminator, version, and field mapping strategies with all the power of OpenJPA's built-in strategies.

### 7.10.1. Custom Class Mapping

To create a custom class mapping, write an implementation of the `org.apache.openjpa.jdbc.meta.ClassStrategy` interface. You will probably want to extend one of the existing abstract or concrete strategies in the `org.apache.openjpa.jdbc.meta.strats` package.

The `org.apache.openjpa.persistence.jdbc.Strategy` annotation allows you to declare a custom class mapping strategy in JPA mapping metadata. Set the value of the annotation to the full class name of your custom strategy. You can configure your strategy class' bean properties using OpenJPA's plugin syntax, detailed in [Section 2.4, “Plugin Configuration”](#) [210].

### 7.10.2. Custom Discriminator and Version Strategies

To define a custom discriminator or version strategy, implement the `org.apache.openjpa.jdbc.meta.DiscriminatorStrategy` or `org.apache.openjpa.jdbc.meta.VersionStrategy` interface, respectively. You might extend one of the existing abstract or concrete strategies in the `org.apache.openjpa.jdbc.meta.strats` package.

OpenJPA includes the `org.apache.openjpa.persistence.jdbc.DiscriminatorStrategy` and `org.apache.openjpa.persistence.jdbc.VersionStrategy` class annotations for declaring a custom discriminator or version strategy in JPA mapping metadata. Set the string value of these annotations to the full class name of your implementation, or to the class name or alias of an existing OpenJPA implementation.

As with custom class mappings, you can configure your strategy class' bean properties using OpenJPA's plugin syntax, detailed in [Section 2.4, “Plugin Configuration” \[210\]](#).

## 7.10.3. Custom Field Mapping

While custom class, discriminator, and version mapping can be useful, custom field mappings are far more common. OpenJPA offers two types of custom field mappings: value handlers, and full custom field strategies. The following sections examine each.

### 7.10.3.1. Value Handlers

Value handlers make it trivial to map any type that you can break down into one or more simple values. All value handlers implement the `org.apache.openjpa.jdbc.meta.ValueHandler` interface; see its [Javadoc](#) for details. Also, examine the built-in handlers in the `src/openjpa/jdbc/meta/strats` directory of your OpenJPA source distribution. Use these functional implementations as examples when you create your own value handlers.

### 7.10.3.2. Field Strategies

OpenJPA interacts with persistent fields through the `org.apache.openjpa.jdbc.meta.FieldStrategy` interface. You can implement this interface yourself to create a custom field strategy, or extend one of the existing abstract or concrete strategies in the `org.apache.openjpa.jdbc.meta.strats` package. Creating a custom field strategy is more difficult than writing a custom value handler, but gives you more freedom in how you interact with the database.

### 7.10.3.3. Configuration

OpenJPA gives you two ways to configure your custom field mappings. The `FieldStrategies` property of the built-in `MappingDefaults` implementations allows you to globally associate field types with their corresponding custom value handler or strategy. OpenJPA will automatically use your custom strategies when it encounters a field of the associated type. OpenJPA will use your custom value handlers whenever it encounters a field of the associated type. [Section 7.4, “Mapping Defaults” \[311\]](#) described mapping defaults in detail.

Your other option is to explicitly install a custom value handler or strategy on a particular field. To do so, specify the full name of your implementation class in the proper mapping metadata extension. OpenJPA includes the `org.apache.openjpa.persistence.jdbc.Strategy` annotation. You can configure the named strategy or handler's bean properties in these extensions using OpenJPA's plugin format (see [Section 2.4, “Plugin Configuration” \[210\]](#)).

## 7.11. Orphaned Keys

Unless you apply database foreign key constraints extensively, it is possible to end up with orphaned keys in your database. For example, suppose `Magazine m` has a reference to `Article a`. If you delete `a` without nulling `m`'s reference, `m`'s database record will wind up with an orphaned key to the non-existent `a` record.

### Note

One way of avoiding orphaned keys is to use *dependent* fields.

OpenJPA's `openjpa.OrphanedKeyAction` configuration property controls what action to take when OpenJPA encounters an orphaned key. You can set this plugin string (see [Section 2.4, “Plugin Configuration” \[210\]](#)) to a custom implementation of the `org.apache.openjpa.event.OrphanedKeyAction` interface, or use one of the built-in options:

- `log`: This is the default setting. This option logs a message for each orphaned key. It is an alias for the `org.apache.openjpa.event.LogOrphanedKeyAction` class, which has the following additional properties:
  - `channel`: The channel to log to. Defaults to `openjpa.Runtime`.

- `Level`: The level to log at. Defaults to `WARN` .
- `exception`: Throw an `EntityNotFoundException` when OpenJPA discovers an orphaned key. This is an alias for the `org.apache.openjpa.event.ExceptionOrphanedKeyAction` class.
- `none`: Ignore orphaned keys. This is an alias for the `org.apache.openjpa.event.NoneOrphanedKeyAction` class.

***Example 7.26. Custom Logging Orphaned Keys***

```
<property name="openjpa.OrphanedKeyAction" value="log(Channel=Orphans, Level=DEBUG)"/>
```



---

# Chapter 8. Deployment

OpenJPA deployment includes choosing a factory deployment strategy, and in a managed environment, optionally integrating with your application server's managed and XA transactions. This chapter examines each aspect of deployment in turn.

## 8.1. Factory Deployment

---

OpenJPA offers two `EntityManagerFactory` deployment options.

### 8.1.1. Standalone Deployment

---

The JPA Overview describes the `javax.persistence.Persistence` class. You can use `Persistence` to obtain `EntityManagerFactory` instances, as demonstrated in [Chapter 6, Persistence \[69\]](#). OpenJPA also extends `Persistence` to add additional `EntityManagerFactory` creation methods. The `org.apache.openjpa.persistence.OpenJPAPersistence` class [Javadoc](#) details these extensions.

After obtaining the factory, you can cache it for all `EntityManager` creation duties. OpenJPA factories support being bound to JNDI as well.

### 8.1.2. EntityManager Injection

---

Java EE application servers allow you to *inject* entity managers into your session beans using the `PersistenceContext` annotation. See your application server documentation for details.

## 8.2. Integrating with the Transaction Manager

---

OpenJPA `EntityManagers` have the ability to automatically synchronize their transactions with an external transaction manager. Whether or not `EntityManagers` from a given `EntityManagerFactory` exhibit this behavior by default depends on the transaction type you set for the factory's persistence unit in your `persistence.xml` file. OpenJPA uses the given transaction type internally to set the `openjpa.TransactionMode` configuration property. This property accepts the following modes:

- `local`: Perform transaction operations locally.
- `managed`: Integrate with the application server's managed global transactions.

You can override the global transaction mode setting when you obtain an `EntityManager` using the `EntityManagerFactory`'s `createEntityManager(Map props)` method. Simply set the `openjpa.TransactionMode` key of the given `Map` to the desired value.

#### Note

You can also override the `openjpa.ConnectionUserName`, `openjpa.ConnectionPassword`, and `openjpa.ConnectionRetainMode` settings using the given `Map`.

In order to use global transactions, OpenJPA must be able to access the application server's `javax.transaction.TransactionManager`. OpenJPA can automatically discover the transaction manager for most major application servers. Occasionally, however, you might have to point OpenJPA to the transaction manager for an unrecognized or non-standard application server setup. This is accomplished through the `openjpa.ManagedRuntime` configuration property. This property describes an `org.apache.openjpa.ee.ManagedRuntime` implementation to use for transaction manager discovery. You can specify your own implementation, or use one of the built-ins:

- `auto`: This is the default. It is an alias for the `org.apache.openjpa.oo AutomaticManagedRuntime` class. This managed runtime is able to automatically integrate with several common application servers.
- `invocation`: An alias for the `org.apache.openjpa.oo InvocationManagedRuntime` class. You can configure this runtime to invoke any static method in order to obtain the appserver's transaction manager.
- `jndi`: An alias for the `org.apache.openjpa.oo JNDIManagedRuntime` class. You can configure this runtime to look up the transaction manager at any JNDI location.

See the Javadoc for of each class for details on the bean properties you can pass to these plugins in your configuration string.

### *Example 8.1. Configuring Transaction Manager Integration*

```
<property name="openjpa.TransactionMode" value="managed" />
<property name="openjpa.ManagedRuntime" value="jndi(TransactionManagerName=java:/TransactionManager)" />
```

## 8.3. XA Transactions

The X/Open Distributed Transaction Processing (X/Open DTP) model, designed by **The Open Group** (a vendor consortium), defines a standard communication architecture that provides the following:

- Concurrent execution of applications on shared resources.
- Coordination of transactions across applications.
- Components, interfaces, and protocols that define the architecture and provide portability of applications.
- Atomicity of transaction systems.
- Single-thread control and sequential function-calling.

The X/Open DTP XA standard defines the application programming interfaces that a resource manager uses to communicate with a transaction manager. The XA interfaces enable resource managers to join transactions, to perform two-phase commit, and to recover in-doubt transactions following a failure.

### 8.3.1. Using OpenJPA with XA Transactions

OpenJPA supports XA-compliant transactions when used in a properly configured managed environment. The following components are required:

- A managed environment that provides an XA compliant transaction manager. Examples of this are application servers such as WebLogic or JBoss.
- Instances of a `javax.sql.XADataSource` for each of the `DataSources` that OpenJPA will use.

Given these components, setting up OpenJPA to participate in distributed transactions is a simple two-step process:

1. Integrate OpenJPA with your application server's transaction manager, as detailed in **Section 8.2, “Integrating with the Transaction Manager”** [333] above.
2. Point OpenJPA at an enlisted `XADataSource`, and configure a second non-enlisted data source. See **Section 4.2.1, “Managed and XA DataSources”** [245].

---

# Chapter 9. Runtime Extensions

This chapter describes OpenJPA extensions to the standard JPA interfaces, and outlines some additional features of the OpenJPA runtime.

## 9.1. Architecture

---

Internally, OpenJPA does not adhere to any persistence specification. The OpenJPA kernel has its own set of APIs and components. Specifications like JPA and JDO are simply different "personalities" that OpenJPA's native kernel can adopt.

As an OpenJPA user, you will not normally see beneath OpenJPA's JPA personality. OpenJPA allows you to access its feature set without leaving the comfort of JPA. Where OpenJPA goes beyond standard JPA functionality, we have crafted JPA-specific APIs to each OpenJPA extension for as seamless an experience as possible.

When writing OpenJPA plugins or otherwise extending the OpenJPA runtime, however, you will use OpenJPA's native APIs. So that you won't feel lost, the list below associates each specification interface with its backing native OpenJPA component:

- `javax.persistence.EntityManagerFactory`: `org.apache.openjpa.kernel.BrokerFactory`
- `javax.persistence.EntityManager`: `org.apache.openjpa.kernel.Broker`
- `javax.persistence.Query`: `org.apache.openjpa.kernel.Query`
- `org.apache.openjpa.persistence.Extent`: `org.apache.openjpa.kernel.Extent`
- `org.apache.openjpa.persistence.StoreCache`: `org.apache.openjpa.datacache.DataCache`
- `org.apache.openjpa.persistence.QueryResultCache`:  
`org.apache.openjpa.datacache.QueryCache`
- `org.apache.openjpa.persistence.FetchPlan`:  
`org.apache.openjpa.kernel.FetchConfiguration`
- `org.apache.openjpa.persistence.Generator`: `org.apache.openjpa.kernel.Seq`

The `org.apache.openjpa.persistence.OpenJPAPersistence` helper allows you to convert between `EntityManagerFactories` and `BrokerFactories`, `EntityManagers` and `Brokers`.

### 9.1.1. Broker Finalization

---

Outside of a Java EE application server or other JPA persistence container environment, the default `OpenJPAEntityManager` implementation automatically closes itself during instance finalization. This guards against accidental resource leaks that may occur if a developer fails to explicitly close `EntityManagers` when finished with them, but it also incurs a scalability bottleneck, since the JVM must perform synchronization during instance creation, and since the finalizer thread will have more instances to monitor. To avoid this overhead, set the `openjpa.BrokerImpl` configuration property to `non-finalizing`.

### 9.1.2. Broker Customization and Eviction

---

As a **plugin string**, this property can be used to configure the `BrokerImpl` with the following properties:

- `EvictFromDataCache`: When evicting an object through the `OpenJPAEntityManager.evict` methods, whether to also evict it from the OpenJPA's **data cache**. Defaults to `false`.

### Example 9.1. Evict from Data Cache

```
<property name="openjpa.BrokerImpl" value="EvictFromDataCache=true"/>
```

Additionally, some advanced users may want to add capabilities to OpenJPA's internal `org.apache.openjpa.kernel.BrokerImpl`. You can configure OpenJPA to use a custom subclass of `BrokerImpl` with the `openjpa.BrokerImpl` configuration property. Set this property to the full class name of your custom subclass. When implementing your subclass, consider the finalization issues mentioned in [Section 9.1.1, “Broker Finalization”](#) [335]. It may be appropriate to create a subtype of both `org.apache.openjpa.kernel.BrokerImpl` and `org.apache.openjpa.kernel.FinalizingBrokerImpl`.

## 9.2. JPA Extensions

The following sections outline the runtime interfaces you can use to access OpenJPA-specific functionality from JPA. Each interface contains services and convenience methods missing from the JPA specification. OpenJPA strives to use the same naming conventions and API patterns as standard JPA methods in all extensions, so that OpenJPA extension APIs feel as much as possible like standard JPA.

You may have noticed the examples throughout this document using the `OpenJPAPersistence.cast` methods to cast from standard JPA interfaces to OpenJPA extended interfaces. This is the recommended practice. Some application server vendors may proxy OpenJPA's JPA implementation, preventing a straight cast. `OpenJPAPersistence`'s `cast` methods work around these proxies.

```
public static OpenJPAEntityManagerFactory cast(EntityManagerFactory emf);
public static OpenJPAEntityManager cast(EntityManager em);
public static OpenJPAQuery cast(Query q);
```

We provide additional information on the `OpenJPAPersistence` helper [below](#).

### 9.2.1. OpenJPAEntityManagerFactory

The `org.apache.openjpa.persistence.OpenJPAEntityManagerFactory` interface extends the basic `javax.persistence.EntityManagerFactory` with OpenJPA-specific features. The `OpenJPAEntityManagerFactory` offers APIs to access the OpenJPA data and query caches and to perform other OpenJPA-specific operations. See the [interface Javadoc](#) for details.

### 9.2.2. OpenJPAEntityManager

All OpenJPA `EntityManagers` implement the `org.apache.openjpa.persistence.OpenJPAEntityManager` interface. This interface extends the standard `javax.persistence.EntityManager`. Just as the standard `EntityManager` is the primary window into JPA services, the `OpenJPAEntityManager` is the primary window from JPA into OpenJPA-specific functionality. We strongly encourage you to investigate the API extensions this interface contains.

### 9.2.3. OpenJPAQuery

OpenJPA extends JPA's standard query functionality with the `org.apache.openjpa.persistence.OpenJPAQuery` interface. See its [Javadoc](#) for details on the convenience methods it provides.

## 9.2.4. Extent

An `Extent` is a logical view of all persistent instances of a given entity class, possibly including subclasses. OpenJPA adds the `org.apache.openjpa.persistence.Extent` class to the set of Java Persistence APIs. The following code illustrates iterating over all instances of the `Magazine` entity, without subclasses:

### *Example 9.2. Using a JPA Extent*

```
import org.apache.openjpa.persistence.*;

...

OpenJPAEntityManager kem = OpenJPAPersistence.cast(em);
Extent<Magazine> mags = kem.createExtent(Magazine.class, false);
for (Magazine m : mags)
    processMagazine(m);
```

## 9.2.5. StoreCache

In addition to the `EntityManager` object cache the JPA specification provides access to a second level cache via the `javax.persistence.Cache` interface. OpenJPA provides further extensions via the `org.apache.openjpa.persistence.StoreCache` interface documented at `org.apache.openjpa.persistence.StoreCache`. [Section 10.1, “Data Cache” \[348\]](#) has detailed information on OpenJPA's data caching system, including the `StoreCache` facade.

## 9.2.6. QueryResultCache

OpenJPA can cache query results as well as persistent object data. The `org.apache.openjpa.persistence.QueryResultCache` is an JPA-flavored facade to OpenJPA's internal query cache. See [Section 10.1.4, “Query Cache” \[355\]](#) for details on query caching in OpenJPA.

## 9.2.7. FetchPlan

Many of the aforementioned OpenJPA interfaces give you access to an `org.apache.openjpa.persistence.FetchPlan` instance. The `FetchPlan` allows you to exercise some control over how objects are fetched from the datastore, including **large result set support**, **custom fetch groups**, and **lock levels**.

OpenJPA goes one step further, extending `FetchPlan` with `org.apache.openjpa.persistence.jdbc.JDBCFetchPlan` to add additional JDBC-specific tuning methods. Unless you have customized OpenJPA to use a non-relational back-end (see [Section 9.8, “Non-Relational Stores” \[347\]](#)), all `FetchPlans` in OpenJPA implement `JDBCFetchPlan`, so feel free to cast to this interface.

Fetch plans pass on from parent components to child components. The `EntityManagerFactory` settings (via your configuration properties) for things like the fetch size, result set type, and custom fetch groups are passed on to the fetch plan of the `EntityManagers` it produces. The settings of each `EntityManager`, in turn, are passed on to each `Query` and `Extent` it returns. Note that the opposite, however, is not true. Modifying the fetch plan of a `Query` or `Extent` does not affect the `EntityManager`'s configuration. Likewise, modifying an `EntityManager`'s configuration does not affect the `EntityManagerFactory`.

[Section 5.7, “Fetch Groups” \[290\]](#) includes examples using `FetchPlans`.

## 9.2.8. OpenJPAEntityTransaction

`org.apache.openjpa.persistence.OpenJPAEntityTransaction` extends `javax.persistence.EntityTransaction` to provide additional transaction-debugging capabilities and some concurrency-related commit and rollback features.

## 9.2.9. OpenJPAPersistence

`org.apache.openjpa.persistence.OpenJPAPersistence` is a static helper class that adds OpenJPA-specific utility methods to `javax.persistence.Persistence`.

## 9.3. Object Locking

Controlling how and when objects are locked is an important part of maximizing the performance of your application under load. This section describes OpenJPA's APIs for explicit locking, as well as its rules for implicit locking.

### 9.3.1. Configuring Default Locking

You can control OpenJPA's default transactional read and write lock levels through the `openjpa.ReadLockLevel` and `openjpa.WriteLockLevel` configuration properties. Each property accepts a value of `none`, `read`, `write`, `optimistic`, `optimistic-force-increment`, `pessimistic-read`, `pessimistic-write`, `pessimistic-force-increment`, or a number corresponding to a lock level defined by the **lock manager** in use. These properties apply only to non-optimistic transactions; during optimistic transactions, OpenJPA never locks objects by default.

You can control the default amount of time OpenJPA will wait when trying to obtain locks through the `openjpa.LockTimeout` configuration property. Set this property to the number of milliseconds you are willing to wait for a lock before OpenJPA will throw an exception, or to -1 for no limit. It defaults to -1.

#### *Example 9.3. Setting Default Lock Levels*

```
<property name="openjpa.ReadLockLevel" value="none"/>
<property name="openjpa.WriteLockLevel" value="write"/>
<property name="openjpa.LockTimeout" value="30000"/>
```

### 9.3.2. Configuring Lock Levels at Runtime

At runtime, you can override the default lock levels through the `FetchPlan` interface described above. At the beginning of each datastore transaction, OpenJPA initializes the `EntityManager`'s fetch plan with the default lock levels and timeouts described in the previous section. By changing the fetch plan's locking properties, you can control how objects loaded at different points in the transaction are locked. You can also use the fetch plan of an individual `Query` to apply your locking changes only to objects loaded through that `Query`.

```
public LockModeType getReadLockMode();
public FetchPlan setReadLockMode(LockModeType mode);
public LockModeType getWriteLockMode();
public FetchPlan setWriteLockMode(LockModeType mode);
long getLockTimeout();
FetchPlan setLockTimeout(long timeout);
```

Controlling locking through these runtime APIs works even during optimistic transactions. At the end of the transaction, OpenJPA resets the fetch plan's lock levels to `none`. You cannot lock objects outside of a transaction.

**Example 9.4. Setting Runtime Lock Levels**

```
import org.apache.openjpa.persistence.*;

...

EntityManager em = ...;
em.getTransaction().begin();

// load stock we know we're going to update at write lock mode
Query q = em.createQuery("select s from Stock s where symbol = :s");
q.setParameter("s", symbol);
OpenJPAQuery oq = OpenJPAPersistence.cast(q);
FetchPlan fetch = oq.getFetchPlan();
fetch.setReadLockMode(LockModeType.WRITE);
fetch.setLockTimeout(3000); // 3 seconds
Stock stock = (Stock) q.getSingleResult();

// load an object we don't need locked at none lock mode
fetch = OpenJPAPersistence.cast(em).getFetchPlan();
fetch.setReadLockMode(null);
Market market = em.find(Market.class, marketId);

stock.setPrice(market.calculatePrice(stock));
em.getTransaction().commit();
```

### 9.3.3. Object Locking APIs

In addition to allowing you to control implicit locking levels, OpenJPA provides explicit APIs to lock objects and to retrieve their current lock level.

```
public LockModeType OpenJPAEntityManager.getLockMode(Object pc);
```

Returns the level at which the given object is currently locked.

In addition to the standard `EntityManager.lock(Object, LockModeType)` method, the `OpenJPAEntityManager` exposes the following methods to lock objects explicitly:

```
public void lock(Object pc);
public void lock(Object pc, LockModeType mode, long timeout);
public void lockAll(Object... pcs);
public void lockAll(Object... pcs, LockModeType mode, long timeout);
public void lockAll(Collection pcs);
public void lockAll(Collection pcs, LockModeType mode, long timeout);
```

Methods that do not take a lock level or timeout parameter default to the current fetch plan. The example below demonstrates these methods in action.

**Example 9.5. Locking APIs**

```
import org.apache.openjpa.persistence.*;

// retrieve the lock level of an object
OpenJPAEntityManager oem = OpenJPAPersistence.cast(em);
Stock stock = ...;
LockModeType level = oem.getLockMode(stock);
```

```

if (level == OpenJPAModeType.WRITE) ...

...

oem.setOptimistic(true);
oem.getTransaction().begin();

// override default of not locking during an opt trans to lock stock object
oem.lock(stock, LockModeType.WRITE, 1000);
stock.setPrice(market.calculatePrice(stock));

oem.getTransaction().commit();

```

## 9.3.4. Lock Manager

OpenJPA delegates the actual work of locking objects to the system's `org.apache.openjpa.kernel.LockManager`. This plugin is controlled by the `openjpa.LockManager` configuration property. You can write your own lock manager, or use one of the bundled options:

- `mixed`: This is an alias for the `org.apache.openjpa.jdbc.kernel.MixedLockManager`, which implements the JPA 2.0 specification entity locking behaviors. It combines both the optimistic and pessimistic semantics controlled by lock mode argument in methods define in the EntityManager and Query interfaces or OpenJPA lock level properties.

The `mixed` LockManager inherits all the properties available from `version` and `pessimistic` LockManagers. For example: `VersionCheckOnReadLock` and `VersionUpdateOnWriteLock` properties.

This is the default `openjpa.LockManager` setting in OpenJPA.

- `pessimistic`: This is an alias for the `org.apache.openjpa.jdbc.kernel.PessimisticLockManager`, which uses SELECT FOR UPDATE statements (or the database's equivalent) to lock the database rows corresponding to locked objects. This lock manager does not distinguish between read locks and write locks; all locks are write locks.

The `pessimistic` LockManager can be configured to additionally perform the version checking and incrementing behavior of the `version` lock manager described below by setting its `VersionCheckOnReadLock` and `VersionUpdateOnWriteLock` properties:

```
<property name="openjpa.LockManager" value="pessimistic(VersionCheckOnReadLock=true,VersionUpdateOnWriteLock=true)"/>
```

- `version`: This is an alias for the `org.apache.openjpa.kernel.VersionLockManager`. This lock manager does not perform any exclusive locking, but instead ensures read consistency by verifying that the version of all read-locked instances is unchanged at the end of the transaction. Furthermore, a write lock will force an increment to the version at the end of the transaction, even if the object is not otherwise modified. This ensures read consistency with non-blocking behavior.
- `none`: This is an alias for the `org.apache.openjpa.kernel.NoneLockManager`, which does not perform any locking at all.

### Note

In order for the `version` or `mixed` lock managers to prevent the dirty read phenomenon, the underlying data store's transaction isolation level must be set to the equivalent of "read committed" or higher.

### Example 9.6. Disabling Locking



```
<property name="openjpa.LockManager" value="none"/>
```

### 9.3.5. Rules for Locking Behavior

Advanced persistence concepts like lazy-loading and object uniquing create several locking corner-cases. The rules below outline OpenJPA's implicit locking behavior in these cases.

1. When an object's state is first read within a transaction, the object is locked at the fetch plan's current read lock level. Future reads of additional lazy state for the object will use the same read lock level, even if the fetch plan's level has changed.
2. When an object's state is first modified within a transaction, the object is locked at the write lock level in effect when the object was first read, even if the fetch plan's level has changed. If the object was not read previously, the current write lock level is used.
3. When objects are accessed through a persistent relation field, the related objects are loaded with the fetch plan's current lock levels, not the lock levels of the object owning the field.
4. Whenever an object is accessed within a transaction, the object is re-locked at the current read lock level. The current read and write lock levels become those that the object "remembers" according to rules one and two above.
5. If you lock an object explicitly through the APIs demonstrated above, it is re-locked at the specified level. This level also becomes both the read and write level that the object "remembers" according to rules one and two above.
6. When an object is already locked at a given lock level, re-locking at a lower level has no effect. Locks cannot be downgraded during a transaction.

### 9.3.6. Known Issues and Limitations

Due to performance concerns and database limitations, locking cannot be perfect. You should be aware of the issues outlined in this section, as they may affect your application.

- Typically, during optimistic transactions OpenJPA does not start an actual database transaction until you flush or the optimistic transaction commits. This allows for very long-lived transactions without consuming database resources. When using the pessimistic lock manager, however, OpenJPA must begin a database transaction whenever you decide to lock an object during an optimistic transaction. This is because the pessimistic lock manager uses database locks, and databases cannot lock rows without a transaction in progress. OpenJPA will log an INFO message to the `openjpa.Runtime` logging channel when it begins a datastore transaction just to lock an object.
- In order to maintain reasonable performance levels when loading object state, OpenJPA can only guarantee that an object is locked at the proper lock level *after* the state has been retrieved from the database. This means that it is technically possible for another transaction to "sneak in" and modify the database record after OpenJPA retrieves the state, but before it locks the object. The only way to positively guarantee that the object is locked and has the most recent state to refresh the object after locking it.

When using the pessimistic lock manager, the case above can only occur when OpenJPA cannot issue the state-loading SELECT as a locking statement due to database limitations. For example, some databases cannot lock SELECTs that use joins. The pessimistic lock manager will log an INFO message to the `openjpa.Runtime` logging channel whenever it cannot lock the initial SELECT due to database limitations. By paying attention to these log messages, you can see where you might consider using an object refresh to guarantee that you have the most recent state, or where you might rethink the way you load the state in question to circumvent the database limitations that prevent OpenJPA from issuing a locking SELECT in the first place.

- When using the pessimistic lock manager and named queries you will see the following WARNING message logged if you do not specify a lockMode on the named query or you explicitly set it to `LockModeType.NONE`. When using the pessimistic lock manager a `LockModeType.NONE` will always be promoted to `LockModeType.READ`.

```
WARN [main] openjpa.MetaData - Encountered a read lock level less than LockModeType.READ when processing the NamedQuery annotation
```

If you are using the pessimistic lock manager and you truly do want to set the lock mode to NONE for a given query, you can use a fetch plan to do so.

```
OpenJPAQuery q = em.createNamedQuery("findEmployeeById");
FetchPlan fp = q.getFetchPlan();
fp.setReadLockMode(LockModeType.NONE);
```

## 9.4. Savepoints

Savepoints allow for fine grained control over the transactional behavior of your application. OpenJPA's savepoint API allow you to set intermediate rollback points in your transaction. You can then choose to rollback changes made only after a specific savepoint, then commit or continue making new changes in the transaction. This feature is useful for multi-stage transactions, such as editing a set of objects over several web pages or user screens. Savepoints also provide more flexibility to conditional transaction behavior, such as choosing to commit or rollback a portion of the transaction based on the results of the changes. This chapter describes how to use and configure OpenJPA savepoints.

### 9.4.1. Using Savepoints

OpenJPA's `OpenJPAEntityManager` have the following methods to control savepoint behavior. Note that the savepoints work in tandem with the current transaction. This means that savepoints require an open transaction, and that a rollback of the transaction will rollback all of the changes in the transaction regardless of any savepoints set.

```
void setSavepoint(String name);
void releaseSavepoint(String name);
void rollbackToSavepoint(String name);
```

To set a savepoint, simply call `setSavepoint`, passing in a symbolic savepoint name. This savepoint will define a point at which you can preserve the state of transactional objects for the duration of the current transaction.

Having set a named savepoint, you can rollback changes made after that point by calling `rollbackToSavepoint`. This method will keep the current transaction active, while restoring all transactional instances back to their saved state. Instances that were deleted after the save point will no longer be marked for deletion. Similarly, transient instances that were made persistent after the savepoint will become transient again. Savepoints made after this savepoint will be released and no longer valid, although you can still set new savepoints. Savepoints will also be cleared after the current transaction is committed or rolled back.

If a savepoint is no longer needed, you can release any resources it is consuming resources by calling `releaseSavepoint`. This method should not be called for savepoints that have been released automatically through other means, such as commit of a transaction or rollback to a prior savepoint. While savepoints made after this savepoint will also be released, there are no other effects on the current transaction.

The following simple example illustrates setting, releasing, and rolling back to a savepoint.

#### *Example 9.7. Using Savepoints*

```

import org.apache.openjpa.persistence.*;

...

OpenJPAEntityManager oem = OpenJPAPersistence.cast(em);
oem.getTransaction().begin();

Magazine mag = oem.find(Magazine.class, id);
mag.setPageCount(300);
oem.setSavepoint("pages");

mag.setPrice(mag.getPageCount() * pricePerPage);
// we decide to release "pages"...
oem.releaseSavepoint("pages");
// ... and set a new savepoint which includes all changes
oem.setSavepoint("price");

mag.setPrice(testPrice);
// we determine the test price is not good
oem.rollbackToSavepoint("price");
// had we chosen to not release "pages", we might have rolled back to
// "pages" instead

// the price is now restored to mag.getPageCount() * pricePerPage
oem.getTransaction().commit();

```

## 9.4.2. Configuring Savepoints

OpenJPA uses the `org.apache.openjpa.kernel.SavepointManager` plugin to handle preserving the savepoint state. OpenJPA includes the following `SavepointManager` plugins:

- `in-mem`: The default. This is an alias for the `org.apache.openjpa.kernel.InMemorySavepointManager`. This plugin stores all state, including field values, in memory. Due to this behavior, each set savepoint is designed for small to medium transactional object counts.
- `jdbc`: This is an alias for the `org.apache.openjpa.jdbc.kernel.JDBC3SavepointManager`. This plugin requires JDBC 3 and `java.sql.Savepoint` support to operate. Note that this plugin implements savepoints by issuing a flush to the database.

## 9.5. MethodQL

If JPQL and SQL queries do not match your needs, OpenJPA also allows you to name a Java method to use to load a set of objects. In a *MethodQL* query, the query string names a static method to invoke to determine the matching objects:

```

import org.apache.openjpa.persistence.*;

...

// the method query language is 'openjpa.MethodQL'.
// set the query string to the target method to execute, prefixed by fully-
// qualified class name.
// If a candidate class has been specified for the query, then if the class is
// in the candidate class' package or in the query imports, you can omit the
// package. If the method is in the candidate class, you can omit the class name
// and just specify the method name.

OpenJPAEntityManager oem = OpenJPAPersistence.cast(emf);
OpenJPAQuery q = oem.createQuery("openjpa.MethodQL", "com.xyz.Finder.getByName");

// parameters are passed the same way as in standard queries
// but you have to declare the parameters with their types on the implementation

// Unwrap the implementation and declare parameters with types in a
// comma-separated list

```

```

q.unwrap(org.apache.openjpa.kernel.Query.class)
  .declareParameters("String firstName, String lastName");

q.setParameter("firstName", "Fred").setParameter("lastName", "Lucas");

// this executes the target method to get the results
List results = q.getResultList();

// The result is returned as a list but the element(s) in the list is determined
// by the returned value of the target method

```

For datastore queries, the method must have the following signature:

```

public static ResultObjectProvider xxx(StoreContext ctx, ClassMetadata meta, boolean subclasses, Map params, FetchConfiguration

```

The returned result object provider should produce objects of the candidate class that match the method's search criteria. If the returned objects do not have all fields in the given fetch configuration loaded, OpenJPA will make additional trips to the datastore as necessary to fill in the data for the missing fields.

In-memory execution is slightly different, taking in one object at a time and returning a boolean on whether the object matches the query:

```

public static boolean xxx(StoreContext ctx, ClassMetadata meta, boolean subclasses, Object obj, Map params, FetchConfiguration fe

```

In both method versions, the given `params` map contains the names and values of all the parameters for the query.

## 9.6. Generators

The JPA Overview's [Chapter 13, \*Mapping Metadata\*](#) [147] details using generators to automatically populate identity fields in JPA.

OpenJPA represents all generators internally with the `org.apache.openjpa.kernel.Seq` interface. This interface supplies all the context you need to create your own custom generators, including the current persistence environment, the `JDBC DataSource`, and other essentials. The `org.apache.openjpa.jdbc.kernel.AbstractJDBCSeq` helps you create custom JDBC-based sequences. OpenJPA also supplies the following built-in `Seq`s:

- `table`: This is OpenJPA's default implementation. It is an alias for the `org.apache.openjpa.jdbc.kernel.TableJDBCSeq` class. The `TableJDBCSeq` uses a special single-row table to store a global sequence number. If the table does not already exist, it is created the first time you run the **mapping tool** on a class that requires it. You can also use the class's `main` method to manipulate the table; see the `TableJDBCSeq.main` method Javadoc for usage details.

This `Seq` has the following properties:

- `Table`: The name of the sequence number table to use. Defaults to `OPENJPA_SEQUENCE_TABLE`. If the entities are mapped to the same table name but with different schema name within one `PersistenceUnit`, one `OPENJPA_SEQUENCE_TABLE` is created for each schema.
- `PrimaryKeyColumn`: The name of the primary key column for the sequence table. Defaults to `ID`.
- `SequenceColumn`: The name of the column that will hold the current sequence value. Defaults to `SEQUENCE_VALUE`.

- **Allocate**: The number of values to allocate on each database trip. Defaults to 50, meaning the class will set aside the next 50 numbers each time it accesses the sequence table, which in turn means it only has to make a database trip to get new sequence numbers once every 50 sequence number requests.
- **class-table**: This is an alias for the `org.apache.openjpa.jdbc.kernel.ClassTableJDBCSeq`. This Seq is like the `TableJDBCSeq` above, but maintains a separate table row, and therefore a separate sequence number, for each base persistent class. It has all the properties of the `TableJDBCSeq`. Its table name defaults to `OPENJPA_SEQUENCES_TABLE`. It also adds the following properties:
  - **IgnoreUnmapped**: Whether to ignore unmapped base classes, and instead use one row per least-derived mapped class. Defaults to `false`.
  - **UseAliases**: Whether to use each class' entity name as the primary key value of each row, rather than the full class name. Defaults to `false`.

As with the `TableJDBCSeq`, the `ClassTableJDBCSeq` creates its table automatically during mapping tool runs. However, you can manually manipulate the table through the class' `main` method. See the Javadoc for the `ClassTableJDBCSeq.main` method for usage details.

- **value-table**: This is an alias for the `org.apache.openjpa.jdbc.kernel.ValueTableJDBCSeq`. This Seq is like the `ClassTableJDBCSeq` above, but has an arbitrary number of rows for sequence values, rather than a fixed pattern of one row per class. Its table defaults to `OPENJPA_SEQUENCES_TABLE`. It has all the properties of the `TableJDBCSeq`, plus:
  - **PrimaryKeyValue**: The primary key value used by this instance.

As with the `TableJDBCSeq`, the `ValueTableJDBCSeq` creates its table automatically during mapping tool runs. However, you can manually manipulate the table through the class' `main` method. See the Javadoc for the `ValueTableJDBCSeq.main` method for usage details.

- **native**: This is an alias for the `org.apache.openjpa.jdbc.kernel.NativeJDBCSeq`. Many databases have a concept of "native sequences" - a built-in mechanism for obtaining incrementing numbers. For example, in Oracle database, you can create a database sequence with a statement like `CREATE SEQUENCE MYSEQUENCE`. Sequence values can then be atomically obtained and incremented with the statement `SELECT MYSEQUENCE.NEXTVAL FROM DUAL`. OpenJPA provides support for this common mechanism of sequence generation with the `NativeJDBCSeq`, which accepts the following properties:
  - **Sequence**: The name of the database sequence. Defaults to `OPENJPA_SEQUENCE`.
  - **InitialValue**: The initial sequence value. Defaults to 1.
  - **Increment**: The amount the sequence increments. Defaults to 1.
  - **Allocate**: The number of values to allocate on each database trip. Defaults to 50, meaning the class will set aside the next 50 numbers each time it accesses the sequence, which in turn means it only has to make a database trip to get new sequence numbers once every 50 sequence number requests.
- **time**: This is an alias for the `org.apache.openjpa.kernel.TimeSeededSeq`. This type uses an in-memory static counter, initialized to the current time in milliseconds and monotonically incremented for each value requested. It is only suitable for single-JVM environments.

You can use JPA `SequenceGenerators` to describe any built-in Seqs or your own Seq implementation. Set the `sequenceName` attribute to a plugin string describing your choice.

If specifying your own class name, you must include parentheses at the end of the class name, even if you have no plugin properties to configure. (E.g., `sequenceName="com.example.SeqImpl()`).

See [Section 13.5, “Generators” \[154\]](#) in the JPA Overview for details on defining `SequenceGenerators`.

See [Section 2.4, “Plugin Configuration” \[210\]](#) for plugin string formatting.

### *Example 9.8. Named Seq Sequence*

```
@Entity
@Table(name="AUTO")
public class Author {

    @Id
    @GeneratedValue(strategy=GenerationType.SEQUENCE, generator="AuthorSeq")
    @SequenceGenerator(name="AuthorSeq", sequenceName="table(Table=AUTO_SEQ)", allocationSize=100)
    @Column(name="AID")
    private long id;

    ...
}
```

Note that if you want to use a plugin string without any arguments, you must still suffix the plugin type with `()` to differentiate it from a sequence name in the `SequenceGenerator.sequenceName` attribute:

```
@SequenceGenerator(name="AuthorSeq", sequenceName="table()")
```

OpenJPA maintains a *system* sequence to generate datastore identity values for classes that do not declare a specific datastore identity strategy. You can configure the system sequence through the `openjpa.Sequence` configuration property. This property accepts a plugin string describing a `Seq` instance.

### *Example 9.9. System Sequence Configuration*

```
<property name="openjpa.Sequence" value="time(Increment=100)"/>
```

In JPA, set your `GeneratedValue` annotation's `strategy` attribute to `AUTO` to use the configured system sequence. Or, because `AUTO` is the default strategy, use the annotation without attributes:

```
@GeneratedValue
private long id;
```

## 9.6.1. Runtime Access

OpenJPA allows you to access named generators at runtime through the `OpenJPAEntityManager.getNamedGenerator` method:

```
public Generator getNamedGenerator(String name);
```

The returned `org.apache.openjpa.persistence.Generator` is a facade over an internal OpenJPA `Seq`.

The `OpenJPAEntityManager` includes additional APIs to retrieve the identity generator of any class, or the generator of any field. With these APIs, you do not have to know the generator name. Additionally, they allow you to access the implicit generator used by default for datastore identity classes. See the **Javadoc** for the `OpenJPAEntityManager.getIdentityGenerator` and `OpenJPAEntityManager.getFieldGenerator` methods for API details.

## 9.7. Transaction Events

---

The OpenJPA runtime supports broadcasting transaction-related events. By registering one or more `org.apache.openjpa.event.TransactionListener`s, you can receive notifications when transactions begin, flush, rollback, commit, and more. Where appropriate, event notifications include the set of persistence-capable objects participating in the transaction.

```
public void addTransactionListener(Object listener);
public void removeTransactionListener(Object listener);
```

These `OpenJPAEntityManagerSPI` methods allow you to add and remove listeners. These methods are outside the bounds of the published OpenJPA APIs, and are subject to change in the future.

For details on the transaction framework, see the `org.apache.openjpa.event` package **Javadoc**. Also see **Section 12.2, “Remote Event Notification Framework” [367]** for a description of OpenJPA's remote event support.

## 9.8. Non-Relational Stores

---

It is possible to adapt OpenJPA to access a non-relational datastore by creating an implementation of the `org.apache.openjpa.kernel.StoreManager` interface. OpenJPA provides an abstract `StoreManager` implementation to facilitate this process. See the `org.apache.openjpa.abstractstore` package **Javadoc** for details.

---

# Chapter 10. Caching

OpenJPA utilizes several configurable caches to maximize performance. This chapter explores OpenJPA's data cache, query cache, and query compilation cache.

## 10.1. Data Cache

---

The OpenJPA data cache is an optional cache of persistent object data that operates at the `EntityManagerFactory` level. This cache is designed to significantly increase performance while remaining in full compliance with the JPA standard. This means that turning on the caching option can transparently increase the performance of your application, with no changes to your code.

OpenJPA's data cache is not related to the `EntityManager` cache dictated by the JPA specification. The JPA specification mandates behavior for the `EntityManager` cache aimed at guaranteeing transaction isolation when operating on persistent objects.

OpenJPA's data cache is designed to provide significant performance increases over cacheless operation, while guaranteeing that behavior will be identical in both cache-enabled and cacheless operation.

There are five ways to access data via the OpenJPA APIs: standard relation traversal, large result set relation traversal, queries, looking up an object by id, and iteration over an `Extent`. OpenJPA's cache plugin accelerates three of these mechanisms. It does not provide any caching of large result set relations or `Extent` iterators. If you find yourself in need of higher-performance `Extent` iteration, see [Example 10.25, “Query Replaces Extent” \[359\]](#).

*Table 10.1. Data access methods*

Access method	Uses cache
Standard relation traversal	Yes
Large result set relation traversal	No
Query	Yes
Lookups by object id	Yes
Iteration over an <code>Extent</code>	No

When enabled, the cache is checked before making a trip to the datastore. Data is stored in the cache when objects are committed and when persistent objects are loaded from the datastore.

OpenJPA's data cache can operate in both single-JVM and multi-JVM environments. Multi-JVM caching is achieved through the use of the distributed event notification framework described in [Section 12.2, “Remote Event Notification Framework” \[367\]](#), or through custom integrations with a third-party distributed cache.

The single JVM mode of operation maintains and shares a data cache across all `EntityManager` instances obtained from a particular `EntityManagerFactory`. This is not appropriate for use in a distributed environment, as caches in different JVMs or created from different `EntityManagerFactory` objects will not be synchronized.

### 10.1.1. Data Cache Configuration

---

There are two ways to enable the basic single-factory cache. One is using `openjpa.DataCache` property, the other is using JPA standard `shared-cache-mode` element or the `javax.persistence.sharedCache.mode` property.

#### 10.1.1.1. openjpa.DataCache Configuration

---

To enable the basic single-factory cache set the `openjpa.DataCache` property to `true`:



### Example 10.1. Single-JVM Data Cache

```
<property name="openjpa.DataCache" value="true"/>
```

To configure the data cache to remain up-to-date in a distributed environment, set the `openjpa.RemoteCommitProvider` property appropriately, or integrate OpenJPA with a third-party caching solution. Remote commit providers are described in [Section 12.2, “Remote Event Notification Framework” \[367\]](#).

OpenJPA's default implementation maintains a map of object ids to cache data. By default, 1000 elements are kept in cache. When the cache overflows, random entries are evicted. The maximum cache size can be adjusted by setting the `CacheSize` property in your plugin string - see below for an example. Objects that are pinned into the cache are not counted when determining if the cache size exceeds its maximum size.

Expired objects are moved to a soft reference map, so they may stick around for a little while longer. You can control the number of soft references OpenJPA keeps with the `SoftReferenceSize` property. Soft references are unlimited by default. Set to 0 to disable soft references completely.

Both the `QueryCache` and `DataCache` can be configured to use a backing `Lru` map rather than the default concurrent `HashMap`. Note that enabling the `Lru` cache can hurt performance as this map is not as scalable as the default map.

### Example 10.2. Lru Cache

```
<property name="openjpa.DataCache" value="true(Lru=true)"/>
<property name="openjpa.QueryCache" value="true(Lru=true)"/>
```

### Example 10.3. Data Cache Size

```
<property name="openjpa.DataCache" value="true(CacheSize=5000, SoftReferenceSize=0)"/>
```

You can specify a cache timeout value for a class by setting the timeout **metadata extension** to the amount of time in milliseconds a class's data is valid. Use a value of -1 for no expiration. This is the default value.

### Example 10.4. Data Cache Timeout

Timeout `Employee` objects after 10 seconds.

```
@Entity
@DataCache(timeout=10000)
public class Employee {
    ...
}
```

Entities may be explicitly excluded from the cache by providing a list of fully qualified class names in the `ExcludedTypes` argument. The entities provided via `ExcludedTypes` will not be cached regardless of the `DataCache` annotation.

### Example 10.5. Excluding entities

Exclude entities `foo.bar.Person` and `foo.bar.Employee` from the cache.

```
<property name="openjpa.DataCache" value="true(ExcludedTypes=foo.bar.Person;foo.bar.Employee)"/>
```

Entities may be explicitly included in the cache by providing a list of fully qualified class names in the `Types` argument. Any entities which are not included in this list will not be cached.

### ***Example 10.6. Including entities***

Include only entity `foo.bar.FullTimeEmployee` in the cache.

```
<property name="openjpa.DataCache" value="true(Types=foo.bar.FullTimeEmployee)"/>
```

See the `org.apache.openjpa.persistence.DataCache` Javadoc for more information on the `DataCache` annotation.

A cache can specify that it should be cleared at certain times rather than using data timeouts. The `EvictionSchedule` property of OpenJPA's cache implementation can be input in two different formats. The first is a cron style eviction schedule. The format of this property is a whitespace-separated list of five tokens, where the `*` symbol (asterisk), indicates match all. The tokens are, in order:

- Minute
- Hour of Day
- Day of Month
- Month
- Day of Week

For example, the following `openjpa.DataCache` setting schedules the default cache to evict values from the cache at 15 and 45 minutes past 3 PM on Sunday.

```
true(EvictionSchedule='15,45 15 * * 1')
```

The second format for this property is an interval style eviction schedule. The format of this property is a `+` followed by the number of minutes between each time that the cache should be evicted.

For example, the following `openjpa.DataCache` setting schedules the default cache to evict values from the cache every 120 minutes.

```
true(EvictionSchedule='+120')
```

### ***Example 10.7. Bulk updates and cache eviction***

Setting `EvictOnBulkUpdate` to `false` will tell OpenJPA to not evict from the `DataCache` when executing an `UPDATE` or `DELETE` statement. The default for the value is `true`.

```
<property name="openjpa.DataCache" value="true(EvictOnBulkUpdate=false)" />
```

### 10.1.1.2. Integration with JPA standard shared cache mode

JPA 2.0 specification introduced the standard data cache configuration through the shared-cache-mode element or `javax.persistence.sharedCache.mode` property.

When only the shared cache mode is configured to turn on the caching, the default data cache setting will be used. For example the cache size will be set to default 1000.

When the shared cache mode and `openjpa.DataCache` are both configured, the JPA standard shared cache mode configuration takes the precedence.

If the shared cache mode is to turn on the caching, the cache setting configured through `openjpa.DataCache`, like `cacheSize` and `SoftReferenceSize`, will be used to initialize or manage the cache. The `Types` and `ExcludeTypes` property in `openjpa.DataCache` will be ignored since the shared cache mode in conjunction with the `javax.persistence.Cacheable` annotation already defines what will be cached.

#### *Example 10.8.*

```
<property name="openjpa.DataCache" value="true" />
<property name="javax.persistence.sharedCache.mode" value="NONE" />
```

When the shared cache mode is set to `NONE`, the data cache will be disabled no matter how `openjpa.DataCache` is configured.

#### *Example 10.9.*

```
<property name="openjpa.DataCache" value="true(ExcludedTypes=foo.bar.Person;foo.bar.Employee)" />
<property name="javax.persistence.sharedCache.mode" value="ALL" />
```

When the shared cache mode is set to `ALL`, all entities will be cached no matter how `openjpa.DataCache` is configured.

#### *Example 10.10.*

```
<property name="openjpa.DataCache" value="true(ExcludedTypes=foo.bar.Person;foo.bar.Employee)" />
<property name="javax.persistence.sharedCache.mode" value="ENABLE_SELECTIVE" />
```

When the shared cache mode set to `ENABLE_SELECTIVE`, the entities with `Cacheable(true)` annotation will be cached. `ExcludeTypes` will be ignored.

### 10.1.1.3. Distributing instances across cache partitions

OpenJPA also supports a partitioned cache configuration where the cached instances can be distributed across partitions by an application-defined policy. Each partition behaves as a data cache by itself, identified by its name and can be configured individually. The distribution policy determines the specific partition that stores the state of a managed instance. The default distribution policy distributes the instances by their type as specified by the `name` attribute in `@DataCache` annotation. Cache

distribution policy is a simple interface that can be implemented by an application to distribute among the partitions on a per instance basis. To enable a partitioned cache set the `openjpa.DataCache` property to `partitioned`, and configure individual partitions as follows:

### *Example 10.11. Partitioned Data Cache*

```
<property name="openjpa.CacheDistributionPolicy" value="org.acme.foo.DistributionPolicy"/>
<property name="openjpa.DataCache" value="partitioned(PartitionType=concurrent,partitions=
'(name=a,cacheSize=100),(name=b,cacheSize=200)')"/>
```

The distribution policy is configured by a full-qualified class name that implements `org.apache.openjpa.datacache.CacheDistributionPolicy`. The partitions are specified as value of the `partitions` attribute as a series of individually configurable plug-in strings. As the example shows, i) each partition plug-in configuration must be enclosed in parentheses, ii) must be separated by comma and iii) the complete set be enclosed in single quote. Each individual partition is a Data Cache by itself and the class that implements the partition can be configured via `PartitionType` attribute. The above example configuration will configure a partitioned cache with two partitions named `a` and `b` of cache size 100 and 200, respectively. The partitions are of `concurrent` type which is a mnemonic or alias for `org.apache.openjpa.datacache.ConcurrentDataCache`. The `PartitionType` is defaulted to `concurrent` though explicitly mentioned in this example.

## 10.1.2. Data Cache Usage

The `org.apache.openjpa.datacache` package defines OpenJPA's data caching framework. While you may use this framework directly (see its **Javadoc** for details), its APIs are meant primarily for service providers. In fact, **Section 10.1.5, “Cache Extension”** [358] below has tips on how to use this package to extend OpenJPA's caching service yourself.

Rather than use the low-level `org.apache.openjpa.datacache` package APIs, JPA users should typically access the data cache through the JPA standard `javax.persistence.Cache` interface, or OpenJPA's high-level `org.apache.openjpa.persistence.StoreCache` facade.

Both interfaces provide methods to evict data from the cache and detect whether an entity is in the cache. The OpenJPA facade adds methods to pin and unpin records, additional methods to evict data, and provides basic statistics of number of read or write requests and hit ratio of the cache.

### 10.1.2.1. Using the JPA standard Cache interface

You may obtain the `javax.persistence.Cache` through the `EntityManagerFactory.getCache()` method.

#### *Example 10.12. Accessing the Cache*

```
import javax.persistence.Cache;
import javax.persistence.EntityManagerFactory;
import javax.persistence.Persistence;
. . .
EntityManagerFactory emf =
    Persistence.createEntityManagerFactory("myPersistenceUnit");
Cache cache = emf.getCache();
. . .
```

#### *Example 10.13. Using the javax.persistence.Cache interface*

```

// Check whether the cache contains an entity with a provided ID
Cache cache = emf.getCache();
boolean contains = cache.contains(MyEntity.class, entityID);

// evict a specific entity from the cache
cache.evict(MyEntity.class, entityID);

// evict all instances of an entity class from the cache
cache.evict(AnotherEntity.class);

// evict everything from the cache
cache.evictAll();

```

### 10.1.2.2. Using the OpenJPA StoreCache extensions

You obtain the `StoreCache` through the `OpenJPAEntityManagerFactory.getStoreCache` method.

#### *Example 10.14. Accessing the StoreCache*

```

import org.apache.openjpa.persistence.*;
...
OpenJPAEntityManagerFactory oemf = OpenJPAPersistence.cast(emf);
StoreCache cache = oemf.getStoreCache();
...

```

Alternatively you can just cast the same object returned from the `EntityManager.getCache()` method.

```

import org.apache.openjpa.persistence.StoreCache;
...
StoreCache cache = (StoreCache) emf.getCache();

```

```

public void evict(Class cls, Object oid);
public void evictAll();
public void evictAll(Class cls, Object... oids);
public void evictAll(Class cls, Collection oids);

```

The `evict` methods tell the cache to release data. Each method takes an entity class and one or more identity values, and releases the cached data for the corresponding persistent instances. The `evictAll` method with no arguments clears the cache. Eviction is useful when the datastore is changed by a separate process outside OpenJPA's control. In this scenario, you typically have to manually evict the data from the datastore cache; otherwise the OpenJPA runtime, oblivious to the changes, will maintain its stale copy.

```

public void pin(Class cls, Object oid);
public void pinAll(Class cls, Object... oids);
public void pinAll(Class cls, Collection oids);
public void unpin(Class cls, Object oid);
public void unpinAll(Class cls, Object... oids);
public void unpinAll(Class cls, Collection oids);

```

Most caches are of limited size. Pinning an identity to the cache ensures that the cache will not kick the data for the corresponding instance out of the cache, unless you manually evict it. Note that even after manual eviction, the data will get

pinned again the next time it is fetched from the store. You can only remove a pin and make the data once again available for normal cache overflow eviction through the `unpin` methods. Use pinning when you want a guarantee that a certain object will always be available from cache, rather than requiring a datastore trip.

### Example 10.15. StoreCache Usage

```
import org.apache.openjpa.persistence.*;
...
OpenJPAEntityManagerFactory oemf = OpenJPAPersistence.cast(emf);
StoreCache cache = oemf.getStoreCache();
cache.pin(Magazine.class, popularMag.getId());
cache.evict(Magazine.class, changedMag.getId());
```

See the `StoreCache` [Javadoc](#) for information on additional functionality it provides. Also, [Chapter 9, Runtime Extensions \[335\]](#) discusses OpenJPA's other extensions to the standard set of JPA runtime interfaces.

The examples above include calls to `evict` to manually remove data from the data cache. Rather than evicting objects from the data cache directly, you can also configure OpenJPA to automatically evict objects from the data cache when you use the `OpenJPAEntityManager`'s eviction APIs.

### Example 10.16. Automatic Data Cache Eviction

```
<property name="openjpa.BrokerImpl" value="EvictFromDataCache=true"/>
```

```
import org.apache.openjpa.persistence.*;
...
OpenJPAEntityManager oem = OpenJPAPersistence.cast(em);
oem.evict(changedMag); // will evict from data cache also
```

## 10.1.3. Cache Statistics

Number of requests to read and write requests and hit ratio of the data cache is available via `org.apache.openjpa.datacache.CacheStatistics` interface. The collection of cache statistics is disabled by default and needs to be enabled on a per cache basis. By default all counts returned from the `CacheStatistics` interface will return 0.

### Example 10.17. Configuring CacheStatistics

```
<property name="openjpa.DataCache" value="true(EnableStatistics=true)"/>
```

Once cache statistics are enabled you can access them via `StoreCache`

```
import org.apache.openjpa.datacache.CacheStatistics;
...
OpenJPAEntityManagerFactory oemf = OpenJPAPersistence.cast(emf);
```

```
CacheStatistics statistics = oemf.getStoreCache().getCacheStatistics();
```

The statistics includes number of read and write requests made to the cache since start and last reset. The statistics can be obtained also per class basis.

```
public interface org.apache.openjpa.datacache.CacheStatistics extends java.io.Serializable{
    // Statistics since last reset
    public long getReadCount();
    public long getHitCount();
    public long getWriteCount();

    // Statistics since start
    public long getTotalReadCount();
    public long getTotalHitCount();
    public long getTotalWriteCount();

    // Per-Class statistics since last reset
    public long getReadCount(java.lang.Class);
    public long getHitCount(java.lang.Class);
    public long getWriteCount(java.lang.Class);

    // Per-Class statistics since start
    public long getTotalReadCount(java.lang.Class);
    public long getTotalHitCount(java.lang.Class);
    public long getTotalWriteCount(java.lang.Class);

    // Starting and last reset time
    public java.util.Date since();
    public java.util.Date start();

    // Resets the statistics.
    public void reset();

    // Returns whether or not statistics will be collected.
    public boolean isEnabled();
}
```

Collecting per-class statistics depends on determining the runtime type of a cached data element, when the given context does not permit determination of exact runtime type, the statistics is registered against generic `java.lang.Object`. Also each method that accepts `Class` argument, treats null argument as `java.lang.Object`

## 10.1.4. Query Cache

In addition to the data cache, the `org.apache.openjpa.datacache` package defines service provider interfaces for a query cache. The query cache is disabled by default and needs to be enabled separately from the data cache. The query cache stores the object ids returned by query executions. When you run a query, OpenJPA assembles a key based on the query properties and the parameters used at execution time, and checks for a cached query result. If one is found, the object ids in the cached result are looked up, and the resultant persistence-capable objects are returned. Otherwise, the query is executed against the database, and the object ids loaded by the query are put into the cache. The object id list is not cached until the list returned at query execution time is fully traversed.

OpenJPA exposes a high-level interface to the query cache through the `org.apache.openjpa.persistence.QueryResultCache` class. You can access this class through the `OpenJPAEntityManagerFactory`.

### *Example 10.18. Accessing the QueryResultCache*

```
import org.apache.openjpa.persistence.*;
...
```

```
OpenJPAEntityManagerFactory oemf = OpenJPAPersistence.cast(emf);
QueryResultCache qcache = oemf.getQueryResultCache();
```

The default query cache implementation caches 100 query executions in a least-recently-used cache. This can be changed by setting the cache size in the `CacheSize` plugin property. Like the data cache, the query cache also has a backing soft reference map. The `SoftReferenceSize` property controls the size of this map. It is disabled by default.

### **Example 10.19. Query Cache Size**

```
<property name="openjpa.QueryCache" value="true(CacheSize=1000, SoftReferenceSize=100)"/>
```

To disable the query cache (default), set the `openjpa.QueryCache` property to `false`:

### **Example 10.20. Disabling the Query Cache**

```
<property name="openjpa.QueryCache" value="false"/>
```

Query Cache's default behaviour on eviction is to evict all the queries from the cache if any of the entities that are in the access path of the query are modified. Scanning through the whole query cache to evict the queries upon an entity update slows down the entity update action. The configurable eviction policy "timestamp" is to track the timestamp of the query and the timestamp of last update for each entity class and compare the timestamps when retrieving the query for reuse. If the timestamp of the query result is older than the last update time of any entity in the access path of the query, the query result would not be reused and the query result would be evicted from the query cache. To configure the `EvictPolicy` to `timestamp`, here is an example:

### **Example 10.21. Query Cache Eviction Policy**

```
<property name="openjpa.QueryCache" value="true(EvictPolicy='timestamp')"/>
```

There are certain situations in which the query cache is bypassed:

- Caching is not used for in-memory queries (queries in which the candidates are a collection instead of a class or `Extent`).
- Caching is not used in transactions that have `IgnoreChanges` set to `false` and in which modifications to classes in the query's access path have occurred. If none of the classes in the access path have been touched, then cached results are still valid and are used.
- Caching is not used in pessimistic transactions, since OpenJPA must go to the database to lock the appropriate rows.
- Caching is not used when the data cache does not have any cached data for an id in a query result.
- Queries that use persistence-capable objects as parameters are only cached if the parameter is directly compared to field, as in:

```
select e from Employee e where e.company.address = :addr
```

If you extract field values from the parameter in your query string, or if the parameter is used in collection element comparisons, the query is not cached.



- Queries that result in projections of custom field types or `BigDecimal` or `BigInteger` fields are not cached.

Cache results are removed from the cache when instances of classes in a cached query's access path are touched. That is, if a query accesses data in class A, and instances of class A are modified, deleted, or inserted, then the cached query result is dropped from the cache.

It is possible to tell the query cache that a class has been altered. This is only necessary when the changes occur via direct modification of the database outside of OpenJPA's control. You can also evict individual queries, or clear the entire cache.

```
public void evict(Query q);
public void evictAll(Class cls);
public void evictAll();
```

For JPA queries with parameters, set the desired parameter values into the `Query` instance before calling the above methods.

### *Example 10.22. Evicting Queries*

```
import org.apache.openjpa.persistence.*;

...

OpenJPAEntityManagerFactory oemf = OpenJPAPersistence.cast(emf);
QueryResultCache qcache = oemf.getQueryResultCache();

// evict all queries that can be affected by changes to Magazines
qcache.evictAll(Magazine.class);

// evict an individual query with parameters
EntityManager em = oemf.createEntityManager();
Query q = em.createQuery(...).
    setParameter(0, paramVal0).
    setParameter(1, paramVal1);
qcache.evict(q);
```

When using one of OpenJPA's distributed cache implementations, it is necessary to perform this in every JVM - the change notification is not propagated automatically. When using a third-party coherent caching solution, it is not necessary to do this in every JVM (although it won't hurt to do so), as the cache results are stored directly in the coherent cache.

Queries can also be pinned and unpinned through the `QueryResultCache`. The semantics of these operations are the same as pinning and unpinning data from the data cache.

```
public void pin(Query q);
public void unpin(Query q);
```

For JPA queries with parameters, set the desired parameter values into the `Query` instance before calling the above methods.

The following example shows these APIs in action.

### *Example 10.23. Pinning, and Unpinning Query Results*

```
import org.apache.openjpa.persistence.*;
```

```

...
OpenJPAEntityManagerFactory oemf = OpenJPAPersistence.cast(emf);
QueryResultCache qcache = oemf.getQueryResultCache();
EntityManager em = emf.createEntityManager();

Query pinQuery = em.createQuery(...).
    setParameter(0, paramVal0).
    setParameter(1, paramVal1);
qcache.pin(pinQuery);
Query unpinQuery = em.createQuery(...).
    setParameter(0, paramVal0).
    setParameter(1, paramVal1);
qcache.unpin(unpinQuery);

```

Pinning data into the cache instructs the cache to not expire the pinned results when cache flushing occurs. However, pinned results will be removed from the cache if an event occurs that invalidates the results.

You can disable caching on a per-EntityManager or per-Query basis:

### **Example 10.24. Disabling and Enabling Query Caching**

```

import org.apache.openjpa.persistence.*;
...
// temporarily disable query caching for all queries created from em
OpenJPAEntityManager oem = OpenJPAPersistence.cast(em);
oem.getFetchPlan().setQueryResultCacheEnabled(false);

// re-enable caching for a particular query
OpenJPAQuery oq = oem.createQuery(...);
oq.getFetchPlan().setQueryResultCacheEnabled(true);

```

## 10.1.5. Cache Extension

The provided data cache classes can be easily extended to add additional functionality. If you are adding new behavior, you should extend `org.apache.openjpa.datacache.ConcurrentDataCache`. To use your own storage mechanism, extend `org.apache.openjpa.datacache.AbstractDataCache` (preferred), or implement `org.apache.openjpa.datacache.DataCache` directly. If you want to implement a distributed cache that uses an unsupported method for communications, create an implementation of `org.apache.openjpa.event.RemoteCommitProvider`. This process is described in greater detail in **Section 12.2.2, “Customization” [369]**.

The query cache is just as easy to extend. Add functionality by extending the default `org.apache.openjpa.datacache.ConcurrentQueryCache`. Implement your own storage mechanism for query results by extending `org.apache.openjpa.datacache.AbstractQueryCache` (preferred) or implementing the `org.apache.openjpa.datacache.QueryCache` interface directly.

## 10.1.6. Important Notes

- The default cache implementations *do not* automatically refresh objects in other EntityManagers when the cache is updated or invalidated. This behavior would not be compliant with the JPA specification.
- Invoking `OpenJPAEntityManager.evict` *does not* result in the corresponding data being dropped from the data cache, unless you have set the proper configuration options as explained above (see **Example 10.16, “Automatic Data Cache Eviction” [354]**). Other methods related to the EntityManager cache also do not affect the data cache.

The data cache assumes that it is up-to-date with respect to the datastore, so it is effectively an in-memory extension of the database. To manipulate the data cache, you should generally use the data cache facades presented in this chapter.

## 10.1.7. Known Issues and Limitations

- When using datastore (pessimistic) transactions in concert with the distributed caching implementations, it is possible to read stale data when reading data outside a transaction.

For example, if you have two JVMs (JVM A and JVM B) both communicating with each other, and JVM A obtains a data store lock on a particular object's underlying data, it is possible for JVM B to load the data from the cache without going to the datastore, and therefore load data that should be locked. This will only happen if JVM B attempts to read data that is already in its cache during the period between when JVM A locked the data and JVM B received and processed the invalidation notification.

This problem is impossible to solve without putting together a two-phase commit system for cache notifications, which would add significant overhead to the caching implementation. As a result, we recommend that people use optimistic locking when using data caching. If you do not, then understand that some of your non-transactional data may not be consistent with the datastore.

Note that when loading objects in a transaction, the appropriate datastore transactions will be obtained. So, transactional code will maintain its integrity.

- `Extents` are not cached. So, if you plan on iterating over a list of all the objects in an `Extent` on a regular basis, you will only benefit from caching if you do so with a `Query` instead:

### *Example 10.25. Query Replaces Extent*

```
import org.apache.openjpa.persistence.*;
...

OpenJPAEntityManager oem = OpenJPAPersistence.cast(em);
Extent extent = oem.createExtent(Magazine.class, false);

// This iterator does not benefit from caching...
Iterator uncachedIterator = extent.iterator();

// ... but this one does.
OpenJPAQuery extentQuery = oem.createQuery(...);
extentQuery.setSubclasses(false);
Iterator cachedIterator = extentQuery.getResultList().iterator();
```

## 10.2. Query Compilation Cache

The query compilation cache is a `Map` used to cache parsed query strings. As a result, most queries are only parsed once in OpenJPA, and cached thereafter. You can control the compilation cache through the `openjpa.QueryCompilationCache` configuration property. This property accepts a plugin string (see [Section 2.4, “Plugin Configuration” \[210\]](#)) describing the `Map` used to associate query strings and their parsed form. This property accepts the following aliases:

**Table 10.2. Pre-defined aliases**

Alias	Value	Notes
true	<code>org.apache.openjpa.util.CacheMap</code>	The default option. Uses a <code>CacheMap</code> to store compilation data. <code>CacheMap</code>

Alias	Value	Notes
		maintains a fixed number of cache entries, and an optional soft reference map for entries that are moved out of the LRU space. So, for applications that have a monotonically increasing number of distinct queries, this option can be used to ensure that a fixed amount of memory is used by the cache.
all	<code>org.apache.openjpa.lib.util.Cache</code>	This is the default, but compilation data is never dropped from the cache, so if you use a large number of dynamic queries, this option may result in ever-increasing memory usage. Note that if your queries only differ in the values of the parameters, this should not be an issue.
false	<i>none</i>	Disables the compilation cache.

## 10.3. Prepared SQL Cache

Prepared SQL Cache caches SQL statements corresponding to JPQL queries. If a query is executed more than once in the same or different persistence contexts, the SQL statement generated during the first execution is cached and executed directly for subsequent execution. Direct execution of SQL offers significant performance gain as it saves the cost of parsing query string and, more importantly, populating the query expression tree during every execution. Relative performance gain becomes higher as the complexity of forming a SQL query from a JPQL string increases. For example, a JPQL query Q1 that involves multiple joins across tables takes more computation to translate into a SQL statement than a JPQL query Q2 to select by simple primary key identifier. Correspondingly, repeated execution of Q1 will gain more performance advantage than Q2 with Prepared SQL Cache.

Prepared SQL Cache is configured by the `openjpa.jdbc.QuerySQLCache` configuration property. This property accepts a plugin string (see [Section 2.4, “Plugin Configuration”](#) [210]) with value of `true` or `false`. The default is `true`. The execution statistics of the cached queries can be optionally collected as

```
<property name="openjpa.jdbc.QuerySQLCache" value="true(EnableStatistics=true)">
```

The `QueryStatistics` can be accessed via `PreparedQueryCache.getStatistics()`.

**Table 10.3. Pre-defined aliases**

Alias	Value	Notes
true	<code>org.apache.openjpa.util.Cache</code>	The default option. Uses a <code>CacheMap</code> to store SQL string. <code>CacheMap</code> maintains a fixed number of cache entries, and an optional soft reference map for entries that are moved out of the LRU space. So, for applications that have a monotonically increasing number of distinct queries, this option can be used to ensure that a fixed amount of memory is used by the cache.

Alias	Value	Notes
false	none	Disables the SQL cache.

Following salient points to be noted regarding usage of Prepared Query Cache.

- Prepared Query Cache uses the original JPQL string as the key to index the corresponding SQL statement. Hence the JPQL strings that are semantically identical but differ by character case or identification variables are considered as different by this cache. One of the implications is that the applications can gain better advantage from the Prepared Query Cache by using parameters in their JPQL query rather than concatenating the parameter values in the query string itself .

For example, contrast the following two examples of executing JPQL queries.

### ***Example 10.26. Hardcoded Selection Value in JPQL Query***

```
String jpql = "SELECT p FROM Person p WHERE p.name='John'";
List johns = em.createQuery(jpql).getResultList();
jpql = "SELECT p FROM Person p WHERE p.name='Tom'";
List toms = em.createQuery(jpql).getResultList();
```

In **Example 10.26, “Hardcoded Selection Value in JPQL Query”** [361], the queries have *hardcoded* the selection value for the `p.name` field. Prepared Query Cache will not recognize the second execution as same as the first, though both will result in same SQL statement.

While in **Example 10.27, “Parameterized Selection Value in JPQL Query”** [361], the selection value for the `p.name` field is parameterized. Prepared Query Cache will recognize the second execution as same as the first, and will execute the cached SQL statement directly.

### ***Example 10.27. Parameterized Selection Value in JPQL Query***

```
String jpql = "SELECT p FROM Person p WHERE p.name=:name";
List johns = em.createQuery(jpql).setParameter("name", "John").getResultList();
List toms = em.createQuery(jpql).setParameter("name", "Tom").getResultList();
```

- A JPQL query may not always translate into a *single* SQL query. The JPQL queries that require multiple select statements are never cached.
- Same JPQL query may result into different SQL statements under different execution context. Execution context parameters such as fetch configuration or locking mode determine the resultant SQL. However, Prepared SQL Cache *does not* capture the execution context parameters while caching a generated SQL.
- The named or positional parameters of a JPQL query can be set to different values across executions. In general, the corresponding cached SQL statement will be re-parameterized accordingly. However, the parameter value itself can determine the SQL query. For example, when a JPQL query compares a relation field for equality against a parameter `p`, whether the actual value of `p` is `null` or not will determine the generated SQL statement. Another example is collection valued parameter for `IN` expression. Each element of a collection valued parameter results into a SQL parameter. If a collection valued parameter across executions are set to different number of elements, then the parameters of the cached SQL do not correspond. If such situations are encountered while re-parameterizing the cached SQL, the cached version is not reused and the original JPQL query is used to generate a new SQL statement for execution.
- JPQL query that returns a *numeric* value such as `SELECT count(p) FROM PObject p` is never cached.

Several mechanisms are available to the application to bypass SQL caching for a JPQL query.

- A user application can disable Prepared SQL Cache for entire lifetime of a persistence context by invoking the following method on OpenJPA's EntityManager SPI interface:

```
OpenJPAEntityManagerSPI.setQuerySQLCache(boolean)
```

- A user application can instruct particular execution of a JPQL query to ignore any cached SQL query, by setting `QueryHints.HINT_IGNORE_PREPARED_QUERY` or `"openjpa.hint.IgnorePreparedQuery"` to `true` via standard `javax.persistence.Query.setHint(String, Object)` method. If a SQL query has been cached corresponding to the JPQL query prior to this execution, then the cached SQL remains in the cache and will be reused for any subsequent execution of the same JPQL query.
- A user application can instruct all subsequent execution of a JPQL query to ignore any cached SQL query, by setting `QueryHints.HINT_INVALIDATE_PREPARED_QUERY` or `"openjpa.hint.InvalidatePreparedQuery"` to `true`. The SQL query is removed from the cache. Also the JPQL query will never be cached again during the lifetime of the entire persistence unit.
- Plug-in property `openjpa.jdbc.QuerySQLCache` can be configured to exclude certain JPQL queries as shown below.

```
<property name="openjpa.jdbc.QuerySQLCache" value="true(excludes='select c from Company c;select d from Department d')"/>
```

will never cache JPQL queries `select c from Company c` and `select d from Department d`.

---

# Chapter 11. Encryption Provider

OpenJPA provides an interface for a provider to implement connection password encryption. Whenever a connection password is needed, the `decrypt(String)` method will be invoked. See `org.apache.openjpa.lib.encrypted.EncryptionProvider` for the detailed Javadoc.

Notes:

- It is an OpenJPA user responsibility to implement the `EncryptionProvider` interface. There is no default implementation.
- The interface has an `encrypt(String)` method, but it is not called by the OpenJPA runtime.

---

# Chapter 12. Remote and Offline Operation

The standard JPA runtime environment was originally just *local* and *online*. It is *local* in that components such as `EntityManager`s and queries connect directly to the datastore and execute their actions in the same JVM as the code using them. It is *online* in that all changes to managed objects must be made in the context of an active `EntityManager`. These two properties, combined with the fact that `EntityManager`s cannot be serialized for storage or network transfer, made the standard JPA runtime difficult to incorporate into some enterprise and client/server program designs.

JPA has now provided *offline* capability through the `detach()` and `merge()` methods on the `EntityManager` interface. OpenJPA has extended this to include additional `detach...()` and `merge...()` methods. All of these are documented in **Detach and Attach APIs**. In addition, OpenJPA has added *remote* capability in the form of **Remote Commit Events**. The following sections explain these capabilities in detail.

## 12.1. Detach and Attach

---

The JPA Overview describes the specification's standard detach and attach APIs in **Section 8.2, “Entity Lifecycle Management” [82]**. This section enumerates OpenJPA's enhancements to the standard behavior.

### 12.1.1. Detach Behavior

---

#### Note

In version 2.0, the detach behavior has changed from the previous version. See the migration section **Detach Behavior** for details.

In JPA, objects detach automatically when they are serialized or when a **persistence context** ends. The specification also allows objects to be explicitly detached using the following `javax.persistence.EntityManager` method:

```
public void detach(Object)
```

`OpenJPAEntityManager`, however, provides additional detach methods.

```
public <T> T detachCopy(T pc):  
public Object[] detachAll(Object... pcs):  
public Collection detachAll(Collection pcs):
```

The behavior of the detach operation is as follows:

- The detached objects are removed from the persistent context.
- The objects are *not* flushed to the database.
- If `Cascade=detach` is specified for a referenced entity, the detach operation is cascaded. Otherwise, it is not.
- For the `detachCopy` method only, the entity is copied for the return value.

### 12.1.2. Attach Behavior

---



When attaching, OpenJPA uses several strategies to determine the optimal way to merge changes made to the detached instance. As you will see, these strategies can even be used to attach changes made to a transient instance which was never detached in the first place.

- If the instance was detached and **detached state** is enabled, OpenJPA will use the detached state to determine the object's version and primary key values. In addition, this state will tell OpenJPA which fields were loaded at the time of detach, and in turn where to expect changes. Loaded detached fields with null values will set the attached instance's corresponding fields to null.
- If the instance has a `Version` field, OpenJPA will consider the object detached if the version field has a non-default value, and new otherwise. Similarly, if the instance has `GeneratedValue` primary key fields, OpenJPA will consider the object detached if any of these fields have non-default values, and new otherwise.

When attaching null fields in these cases, OpenJPA cannot distinguish between a field that was unloaded and one that was intentionally set to null. In this case, OpenJPA will use the current **detach state** setting to determine how to handle null fields: fields that would have been included in the detached state are treated as loaded, and will in turn set the corresponding attached field to null.

- If neither of the above cases apply, OpenJPA will check to see if an instance with the same primary key values exists in the database. If so, the object is considered detached. Otherwise, it is considered new.

These strategies will be assigned on a per-instance basis, such that during the attachment of an object graph more than one of the above strategies may be used.

If you attempt to attach a versioned instance whose representation has changed in the datastore since detachment, OpenJPA will throw an optimistic concurrency exception upon commit or flush, just as if a normal optimistic conflict was detected. When attaching an instance whose database record has been deleted since detaching, or when attaching a detached instance into a manager that has a stale version of the object, OpenJPA will throw an optimistic concurrency exception from the attach method. In these cases, OpenJPA sets the `RollbackOnly` flag on the transaction.

### 12.1.3. Defining the Detached Object Graph

When detached objects lose their association with the OpenJPA runtime, they also lose the ability to load additional state from the datastore. It is important, therefore, to populate objects with all the persistent state you will need before detaching them. While you are free to do this manually, OpenJPA includes facilities for automatically populating objects when they detach.

#### 12.1.3.1. Detached State

The `openjpa.DetachState` configuration property determines which fields and relations are detached by default. All settings are recursive. They are:

1. `loaded`: Detach all fields and relations that are already loaded, but don't include unloaded fields in the detached graph. This is the default.
2. `fetch-groups`: Detach all fields and relations in the current **fetch configuration**. For more information on custom fetch groups, see [Section 5.7, “Fetch Groups” \[290\]](#).
3. `all`: Detach all fields and relations. Be very careful when using this mode; if you have a highly-connected domain model, you could end up bringing every object in the database into memory!

Any field that is not included in the set determined by the detach mode is set to its Java default value in the detached instance.

The `openjpa.DetachState` option is actually a plugin string (see [Section 2.4, “Plugin Configuration” \[210\]](#)) that allows you to also configure the following options related to detached state:

- `DetachedStateField`: As described in [Section 12.1.2, “Attach Behavior” \[364\]](#) above, OpenJPA can take advantage of a *detached state field* to make the attach process more efficient. This field is added by the enhancer and is not visible to your application. Set this property to one of the following values:

- `transient`: Use a transient detached state field. This gives the benefits of a detached state field to local objects that are never serialized, but retains serialization compatibility for client tiers without access to the enhanced versions of your classes or the OpenJPA runtime. This is the default.
- `true`: Use a non-transient detached state field so that objects crossing serialization barriers can still be attached efficiently. This requires, however, that your client tier have the enhanced versions of your classes and the OpenJPA runtime.
- `false`: Do not use a detached state field. No OpenJPA runtime will be required for client tiers.

The detached state field is also used to determine when proxies should be removed from entities during serialization. See the [Section 5.6.4.4, “Serialization” \[287\]](#) section for more details.

You can override the setting of this property or declare your own detached state field on individual classes using OpenJPA's metadata extensions. See [Section 12.1.3.2, “Detached State Field” \[367\]](#) below.

- `DetachedStateManager`: Whether to use a detached state manager. A detached state manager makes attachment much more efficient. Like a detached state field, however, it breaks serialization compatibility with the unenhanced class if it isn't transient.

This setting piggybacks on the `DetachedStateField` setting above. If your detached state field is transient, the detached state manager will also be transient. If the detached state field is disabled, the detached state manager will also be disabled. This is typically what you'll want. By setting `DetachedStateField` to `true` (or `transient`) and setting this property to `false`, however, you can use a detached state field **without** using a detached state manager. This may be useful for debugging or for legacy OpenJPA users who find differences between OpenJPA's behavior with a detached state manager and OpenJPA's older behavior without one.

- `AccessUnloaded`: Whether to allow access to unloaded fields of detached objects. Defaults to `true`. Set to `false` to throw an exception whenever an unloaded field is accessed. This option is only available when you use detached state managers, as determined by the settings above.
- `LiteAutoDetach`: **This option is ONLY valid for the loaded `DetachState` setting.** Detach all fields and relations as described by the loaded property when an explicit detach is requested or when a single Entity is being detached as part of serialization. When the entire persistence context is being auto-detached ( `openjpa.AutoDetach` ), the minimal amount of work will be completed to disassociate all Entities from the persistence context. **It is highly recommended that all Entities have a `@Version` field when using this property.** In addition, care needs to be taken when this value is set to `true` as the following caveats apply:
  - A relationship from a managed Entity to an unmanaged Entity which was detached by the lite detach setting will not be persisted.
  - When merging a detached Entity back into the persistence context any lazily loaded fields that were marked to null when detached will not be persisted.
- `DetachProxyFields`: **This option is ONLY valid when used in conjunction with the `LiteAutoDetach DetachState` setting.** When detaching the persistence context, all proxies will be left in place. Note, that all `Large Result Sets` will be removed.
  - `true`(default): All proxies will be removed and LRS fields will be removed.
  - `false`: All proxies will be left in place and LRS fields will be removed.

### Example 12.1. Configuring Detached State

```
<property name="openjpa.DetachState" value="fetch-groups(DetachedStateField=true)"/>
```

You can also alter the set of fields that will be included in the detached graph at runtime. `OpenJPAEntityManagers` expose the following APIs for controlling detached state:

```
public DetachStateType getDetachState();
public void setDetachState(DetachStateType type);
```

The `DetachStateType` enum contains the following values:

```
enum DetachStateType {
    FETCH_GROUPS,
    LOADED,
    ALL
}
```

### 12.1.3.2. Detached State Field

When the detached state field is enabled, the OpenJPA enhancer adds an additional field to the enhanced version of your class. This field of type `Object`. OpenJPA uses this field for bookkeeping information, such as the versioning data needed to detect optimistic concurrency violations when the object is re-attached.

It is possible to define this detached state field yourself. Declaring this field in your class metadata prevents the enhancer from adding any extra fields to the class, and keeps the enhanced class serialization-compatible with the unenhanced version. The detached state field must not be persistent. See [Section 6.4.1.3, “Detached State” \[300\]](#) for details on how to declare a detached state field.

```
import org.apache.openjpa.persistence.*;

@Entity
public class Magazine
    implements Serializable {
    private String name;
    @DetachedState private Object state;
    ...
}
```

## 12.2. Remote Event Notification Framework

The remote event notification framework allows a subset of the information available through OpenJPA's transaction events (see [Section 9.7, “Transaction Events” \[347\]](#)) to be broadcast to remote listeners. OpenJPA's `data cache`, for example, uses remote events to remain synchronized when deployed in multiple JVMs.

To enable remote events, you must configure the `EntityManagerFactory` to use a `RemoteCommitProvider` (see below).

When a `RemoteCommitProvider` is properly configured, you can register `RemoteCommitListeners` that will be alerted with a list of modified object ids whenever a transaction on a remote machine successfully commits.

### 12.2.1. Remote Commit Provider Configuration

OpenJPA includes built in remote commit providers for JMS and TCP communication.

### 12.2.1.1. JMS

The JMS remote commit provider can be configured by setting the `openjpa.RemoteCommitProvider` property to contain the appropriate configuration properties. The JMS provider understands the following properties:

- `Topic`: The topic that the remote commit provider should publish notifications to and subscribe to for notifications sent from other JVMs. Defaults to `topic/OpenJPACommitProviderTopic`
- `TopicConnectionFactory`: The JNDI name of a `javax.jms.TopicConnectionFactory` factory to use for finding topics. Defaults to `java:/ConnectionFactory`. This setting may vary depending on the application server in use; consult the application server's documentation for details of the default JNDI name for the `javax.jms.TopicConnectionFactory` instance. For example, under Weblogic, the JNDI name for the `TopicConnectionFactory` is `javax.jms.TopicConnectionFactory`.
- `ExceptionReconnectAttempts`: The number of times to attempt to reconnect if the JMS system notifies OpenJPA of a serious connection error. Defaults to 0, meaning OpenJPA will log the error but otherwise ignore it, hoping the connection is still valid.
- `*`: All other configuration properties will be interpreted as settings to pass to the JNDI `InitialContext` on construction. For example, you might set the `java.naming.provider.url` property to the URL of the context provider.

To configure a factory to use the JMS provider, your properties might look like the following:

#### *Example 12.2. JMS Remote Commit Provider Configuration*

```
<property name="openjpa.RemoteCommitProvider"
  value="jms(ExceptionReconnectAttempts=5)"/>
```

#### Note

Because of the nature of JMS, it is important that you invoke `EntityManagerFactory.close` when finished with a factory. If you do not do so, a daemon thread will stay up in the JVM, preventing the JVM from exiting.

### 12.2.1.2. TCP

The TCP remote commit provider has several options that are defined as host specifications containing a host name or IP address and an optional port separated by a colon. For example, the host specification `saturn.bea.com:1234` represents an `InetAddress` retrieved by invoking `InetAddress.getByName("saturn.bea.com")` and a port of 1234.

The TCP provider can be configured by setting the `openjpa.RemoteCommitProvider` plugin property to contain the appropriate configuration settings. The TCP provider understands the following properties:

- `Port`: The TCP port that the provider should listen on for commit notifications. Defaults to 5636.
- `Addresses`: A semicolon-separated list of IP addresses to which notifications should be sent. No default value.
- `NumBroadcastThreads`: The number of threads to create for the purpose of transmitting events to peers. You should increase this value as the number of concurrent transactions increases. The maximum number of concurrent transactions is a function of the size of the connection pool. See the `MaxActive` property of `openjpa.ConnectionFactoryProperties` in [Section 4.1, “Using the OpenJPA DataSource” \[243\]](#). Setting a value of 0 will result in behavior where the thread invoking `commit` will perform the broadcast directly. Defaults to 2.

- `RecoveryTimeMillis`: Amount of time to wait in milliseconds before attempting to reconnect to a peer of the cluster when connectivity to the peer is lost. Defaults to 15000.
- `MaxIdle`: The number of TCP sockets (channels) to keep open to each peer in the cluster for the transmission of events. Defaults to 2.
- `MaxActive`: The maximum allowed number of TCP sockets (channels) to open simultaneously between each peer in the cluster. Defaults to 2.

To configure a factory to use the TCP provider, your properties might look like the following:

### *Example 12.3. TCP Remote Commit Provider Configuration*

```
<property name="openjpa.RemoteCommitProvider"
  value="tcp(Addresses=10.0.1.10;10.0.1.11;10.0.1.12;10.0.1.13)"/>
```

## 12.2.1.3. Common Properties

In addition to the provider-specific configuration options above, all providers accept the following plugin properties:

- `TransmitPersistedObjectIds`: Whether remote commit events will include the object ids of instances persisted in the transaction. By default only the class names of types persisted in the transaction are sent. This results in smaller events and more efficient network utilization. If you have registered your own remote commit listeners, however, you may require the persisted object ids as well.

To transmit persisted object ids in our remote commit events using the JMS provider, we modify the previous example as follows:

### *Example 12.4. JMS Remote Commit Provider transmitting Persisted Object Ids*

```
<property name="openjpa.RemoteCommitProvider"
  value="jms(ExceptionReconnectAttempts=5, TransmitPersistedObjectIds=true)"/>
```

## 12.2.2. Customization

You can develop additional mechanisms for remote event notification by creating an implementation of the `RemoteCommitProvider` interface, possibly by extending the `AbstractRemoteCommitProvider` abstract class..

---

# Chapter 13. Slice: Distributed Persistence

The standard JPA runtime environment works with a *single* database instance. *Slice* is a plug-in module for OpenJPA to work with *multiple* databases within the same transaction. Following sections describe the features and usage of *Slice* for distributed database environment.

## 13.1. Overview

---

Enterprise applications are increasingly deployed in distributed database environment. A distributed, horizontally-partitioned database environment can be an effective scaling strategy for growing data volume, to support multiple clients on a multi-tenant hosting platform and many other practical scenarios that can benefit from data partitioning.

Any JPA-based user application has to address demanding technical and conceptual challenges to interact with multiple physical databases within a single transaction. OpenJPA *Slice* encapsulates the complexity of distributed database environment via the abstraction of *virtual* database which internally manages multiple physical database instances referred as *slice*. *Virtualization* of distributed databases makes OpenJPA object management kernel and the user application to work in the same way as in the case of a single physical database.

## 13.2. Salient Features

---

### 13.2.1. Transparency

---

The primary design objective for *Slice* is to make the user application transparent to the change in storage strategy where data resides in multiple (possibly heterogeneous) databases instead of a single database. *Slice* achieves this transparency by virtualization of multiple databases as a single database such that OpenJPA object management kernel continues to interact in exactly the same manner with storage layer. Similarly, the existing application or the persistent domain model requires *no change* to upgrade from a single database to a distributed database environment.

An existing application developed for a single database can be adapted to work with multiple databases purely by configuring a persistence unit via `META-INF/persistence.xml`.

### 13.2.2. Scaling

---

The primary performance characteristics for *Slice* is to scale against growing data volume by *horizontal* partitioning data across many databases.

*Slice* executes the database operations such as query or flush *in parallel* across each physical database. Hence, scaling characteristics against data volume are bound by the size of the maximum data partition instead of the size of the entire data set. The use cases where the data is naturally amenable to horizontal partitions, for example, by temporal interval (e.g. Purchase Orders per month) or by geographical regions (e.g. Customer by Zip Code) can derive significant performance benefit and favorable scaling behavior by using *Slice*.

### 13.2.3. Distributed Query

---

The queries are executed in parallel across one or more slices and the individual query results are merged into a single list before being returned to the caller application. The *merge* operation is more complex for the queries that involve sorting and/or specify a range. *Slice* supports both sorting and range queries.

*Slice* also supports aggregate queries where the aggregate operation is *commutative* to partitioning such as `COUNT()` or `MAX()` but not `AVG()`.

By default, any query is executed against all available slices. However, the application can target the query only to a subset of slices by setting *hint* on `javax.persistence.Query`. The hint key is `openjpa.hint.slice.Target` and hint value is an array of slice identifiers. The following example shows how to target a query only to a pair of slices with logical identifier "One" and "Two".

```
EntityManager em = ...;
em.getTransaction().begin();
String hint = "openjpa.hint.slice.Target";
Query query = em.createQuery("SELECT p FROM PObject")
    .setHint(hint, new String[]{"One", "Two"});
List result = query.getResultList();
// verify that each instance is originating from the hinted slices
for (Object pc : result) {
    String sliceOrigin = SlicePersistence.getSlice(pc);
    assertTrue ("One".equals(sliceOrigin) || "Two".equals(sliceOrigin));
}
```

To confine queries to a subset of slices via setting query hints can be considered intrusive to existing application. The alternative means of targeting queries is to configure a *Query Target Policy*. This policy is configured via plug-in property `openjpa.slice.QueryTargetPolicy`. The plug-in property is fully-qualified class name of an implementation for `org.apache.openjpa.slice.QueryTargetPolicy` interface. This interface contract allows a user application to target a query to a subset of slices based on the query and its bound parameters. The query target policy is consulted only when no explicit target hint is set on the query. By default, the policy executes a query on all available slices.

A similar policy interface `org.apache.openjpa.slice.FinderTargetPolicy` is available to target queries that originate from `find()` by primary key. This finder target policy is consulted only when no explicit target hint is set on the current fetch plan. By default, the policy executes a query on all available slices to find an instance by its primary key.

## 13.2.4. Data Distribution

The user application decides how the newly persistent instances be distributed across the slices. The user application specifies the data distribution policy by implementing `org.apache.openjpa.slice.DistributionPolicy`. The `DistributionPolicy` interface is simple with a single method. The complete listing of the documented interface follows:

```
public interface DistributionPolicy {
    /**
     * Gets the name of the slice where the given newly persistent
     * instance will be stored.
     *
     * @param pc The newly persistent or to-be-merged object.
     * @param slices name of the configured slices.
     * @param context persistence context managing the given instance.
     *
     * @return identifier of the slice. This name must match one of the
     *         configured slice names.
     * @see DistributedConfiguration#getSliceNames()
     */
    String distribute(Object pc, List<String> slices, Object context);
}
```

Slice runtime invokes this user-supplied method for the newly persistent instance that is explicit argument of the `javax.persistence.EntityManager.persist(Object pc)` method. The user application must return a valid slice name from this method to designate the target slice for the given instance. The data distribution policy may be based on the attribute of the data itself. For example, all Customer whose first name begins with character 'A' to 'M' will be stored in one slice

while names beginning with 'N' to 'Z' will be stored in another slice. The noteworthy aspect of such policy implementation is the attribute values that participate in the distribution policy logic should be set before invoking `EntityManager.persist()` method.

The user application needs to specify the target slice *only* for the *root* instance i.e. the explicit argument for the `EntityManager.persist(Object pc)` method. Slice computes the transitive closure of the graph i.e. the set of all instances directly or indirectly reachable from the root instance and stores them in the same target slice.

Slice tracks the original database for existing instances. When an application issues a query, the resultant instances can be loaded from different slices. As Slice tracks the original slice for each instance, any subsequent update to an instance is committed to the appropriate original database slice.

### Note

You can find the original slice of an instance `pc` by the static utility method `SlicePersistence.getSlice(pc)`. This method returns the slice identifier associated with the given *managed* instance. If the instance is not being managed then the method return null because any unmanaged or detached instance is not associated with any slice.

## 13.2.5. Data Replication

While Slice ensures that the transitive closure is stored in the same slice, there can be data elements that are commonly referred by many instances such as Country or Currency code. Such quasi-static master data can be stored as identical copies in multiple slices. The user application must enumerate the replicated entity type names in `openjpa.slice.ReplicatedTypes` as a comma-separated list and implement a `org.apache.openjpa.slice.ReplicationPolicy` interface. The `ReplicationPolicy` interface is quite similar to `DistributionPolicy` interface except it returns an array of target slice names instead of a single slice.

```
String[] replicate(Object pc, List<String> slices, Object context);
```

The default implementation assumes that replicated instances are stored in all available slices. If any such replicated instance is modified then the modification is updated to all target slices to maintain the critical assumption that the state of a replicated instance is identical across all its target slices.

## 13.2.6. Heterogeneous Database

Each slice can be configured independently with its own JDBC driver and other connection parameters. Hence the target database environment can constitute of heterogeneous databases.

## 13.2.7. Distributed Transaction

The database slices participate in a global transaction provided each slice is configured with a XA-compliant JDBC driver, even when the persistence unit is configured for `RESOURCE_LOCAL` transaction.

### Warning

If any of the configured slices is not XA-compliant *and* the persistence unit is configured for `RESOURCE_LOCAL` transaction then each slice is committed without any two-phase commit protocol. If commit on any slice fails, then atomic nature of the transaction is not ensured.



## 13.2.8. Collocation Constraint

No relationship can exist across database slices. In O-R mapping parlance, this condition translates to the limitation that the transitive closure of an object graph must be *collocated* in the same database. For example, consider a domain model where Person relates to Address. Person X refers to Address A while Person Y refers to Address B. Collocation Constraint means that *both* X and A must be stored in the same database slice. Similarly Y and B must be stored in a single slice.

Slice, however, helps to maintain collocation constraint automatically. The instances in the closure set of any newly persistent instance reachable via cascaded relationship is stored in the same slice. The user-defined distribution policy requires to supply the slice for the root instance only.

## 13.3. Usage

Slice is activated via the following property settings:

### 13.3.1. How to activate Slice Runtime?

The basic configuration property is

```
<property name="openjpa.BrokerFactory" value="slice"/>
```

This critical configuration activates a specialized object management kernel that can work against multiple databases.

### 13.3.2. How to configure each database slice?

Each database slice is identified by a logical name unique within a persistent unit. The list of the slices is specified by `openjpa.slice.Names` property. For example, specify three slices named "One", "Two" and "Three" as follows:

```
<property name="openjpa.slice.Names" value="One, Two, Three"/>
```

This property is not mandatory. If this property is not specified then the configuration is scanned for logical slice names. Any property "abc" of the form `openjpa.slice.XYZ.abc` will register a slice with logical name "XYZ".

The order of the names is significant when no `openjpa.slice.Master` property is not specified. The persistence unit is then scanned to find all configured slice names and they are ordered alphabetically.

Each database slice properties can be configured independently. For example, the following configuration will register two slices with logical name One and Two.

```
<property name="openjpa.slice.One.ConnectionURL" value="jdbc:mysql:localhost//slice1"/>
<property name="openjpa.slice.Two.ConnectionURL" value="jdbc:mysql:localhost//slice2"/>
```

Any OpenJPA specific property can be configured per slice basis. For example, the following configuration will use two different JDBC drivers for slice One and Two.

```
<property name="openjpa.slice.One.ConnectionDriverName" value="com.mysql.jdbc.Driver"/>
<property name="openjpa.slice.Two.ConnectionDriverName" value="com.mysql.jdbc.jdbc2.optional.MysqlXADataSource"/>
```

Any property if unspecified for a particular slice will be defaulted by corresponding OpenJPA property. For example, consider following three slices

```
<property name="openjpa.slice.One.ConnectionURL" value="jdbc:mysql:localhost//slice1"/>
<property name="openjpa.slice.Two.ConnectionURL" value="jdbc:mysql:localhost//slice2"/>
<property name="openjpa.slice.Three.ConnectionURL" value="jdbc:oracle:localhost//slice3"/>

<property name="openjpa.ConnectionDriverName" value="com.mysql.jdbc.Driver"/>
<property name="openjpa.slice.Three.ConnectionDriverName" value="oracle.jdbc.Driver"/>
```

In this example, Three will use slice-specific `oracle.jdbc.Driver` driver while slice One and Two will use the driver `com.mysql.jdbc.Driver` as specified by `openjpa.ConnectionDriverName` property value.

A connection pool may also be used with Slice by using the `openjpa.ConnectionProperties` property. For example to use `commons-dbcp` with `Derby` you might use the following properties :

```
<property name="openjpa.BrokerFactory" value="slice"/>
<property name="openjpa.ConnectionDriverName" value="org.apache.commons.dbcp.BasicDataSource"/>
<property name="openjpa.slice.Names" value="One,Two"/>
<property name="openjpa.slice.Master" value="Two"/>

<property name="openjpa.slice.One.ConnectionProperties" value="Url=jdbc:derby:target/database/openjpa-slice1;create=true;useUnicode=true;characterEncoding=utf-8;serverTimezone=UTC"/>
<property name="openjpa.slice.Two.ConnectionProperties" value="Url=jdbc:derby:target/database/openjpa-slice2;create=true;useUnicode=true;characterEncoding=utf-8;serverTimezone=UTC"/>

<property name="openjpa.jdbc.DBDictionary" value="derby"/>
```

## Note

Be aware that you need to set the `DBDictionary` when using `commons-dbcp`.

### 13.3.3. Implement `DistributionPolicy` interface

Slice needs to determine which slice will persist a new instance. The application can only decide this policy (for example, all `PurchaseOrders` before April 30 goes to slice One, all the rest goes to slice Two). This is why the application has to implement `org.apache.openjpa.slice.DistributionPolicy` and specify the implementation class in configuration

```
<property name="openjpa.slice.DistributionPolicy" value="com.acme.foo.MyOptimialDistributionPolicy"/>
```

The interface `org.apache.openjpa.slice.DistributionPolicy` is simple with a single method. The complete listing of the documented interface follows:

```

public interface DistributionPolicy {
    /**
     * Gets the name of the slice where a given instance will be stored.
     *
     * @param pc The newly persistent or to-be-merged object.
     * @param slices name of the configured slices.
     * @param context persistence context managing the given instance.
     *
     * @return identifier of the slice. This name must match one of the
     *         configured slice names.
     * @see DistributedConfiguration#getSliceNames()
     */
    String distribute(Object pc, List<String> slices, Object context);
}

```

While implementing a distribution policy the most important thing to remember is **collocation constraint**. Because Slice can not establish or query any cross-database relationship, all the related instances must be stored in the same database slice. Slice can determine the closure of a root object by traversal of cascaded relationships. Hence user-defined policy has to only decide the database for the root instance that is the explicit argument to `EntityManager.persist()` call. Slice will ensure that all other related instances that get persisted by cascade are assigned to the same database slice as that of the root instance. However, the user-defined distribution policy must return the same slice identifier for the instances that are logically related but not cascaded for persist.

### 13.3.4. Implement ReplicationPolicy interface

The entities that are enumerated in `openjpa.slice.ReplicatedTypes` property can be stored in multiple slices as identical copies. Specify the implementation class of `ReplicationPolicy` in configuration as

```
<property name="openjpa.slice.ReplicationPolicy" value="com.acme.foo.MyReplicationPolicy"/>
```

## 13.4. Configuration Properties

The properties to configure Slice can be classified in two broad groups. The *global* properties apply to all the slices, for example, the thread pool used to execute the queries in parallel or the transaction manager used to coordinate transaction across multiple slices. The *per-slice* properties apply to individual slice, for example, the JDBC connection URL of a slice.

### 13.4.1. Global Properties

#### 13.4.1.1. openjpa.slice.DistributionPolicy

This *mandatory* plug-in property determines how newly persistent instances are distributed across individual slices. The value of this property is a fully-qualified class name that implements `org.apache.openjpa.slice.DistributionPolicy` interface.

#### 13.4.1.2. openjpa.slice.Lenient

This boolean plug-in property controls the behavior when one or more slice can not be connected or unavailable for some other reasons. If `true`, the unreachable slices are ignored. If `false` then any unreachable slice will raise an exception during startup.

By default this value is set to `false` i.e. all configured slices must be available.

### 13.4.1.3. openjpa.slice.Master

---

The user application often directs OpenJPA to generate primary keys for persistence instances automatically or from a specific database sequence. For such primary key value generation strategy where a database instance is required, Slice uses a designated slice referred to as *master* slice.

The master slice can be specified explicitly via `openjpa.slice.Master` property and whose value is one of the configured slice names. If this property is not explicitly specified then, by default, the master slice is the first slice in the list of configured slice names.

#### Warning

Currently, there is no provision to use sequence from multiple slices.

### 13.4.1.4. openjpa.slice.Names

---

This plug-in property can be used to register the logical slice names. The value of this property is comma-separated list of slice names. The ordering of the names in this list is *significant* because **DistributionPolicy** and **ReplicationPolicy** receive the input argument of the slice names in the same order.

If logical slice names are not registered explicitly via this property, then all logical slice names available in the persistence unit are registered. The ordering of the slice names in this case is alphabetical.

If logical slice names are registered explicitly via this property, then any logical slice that is available in the persistence unit but excluded from this list is ignored.

### 13.4.1.5. openjpa.slice.ThreadingPolicy

---

This plug-in property determines the nature of thread pool being used for database operations such as query or flush on individual slices. The value of the property is a fully-qualified class name that implements `java.util.concurrent.ExecutorService` interface. Two pre-defined pools can be chosen via their aliases namely `fixed` or `cached`.

The pre-defined alias `cached` activates a **cached thread pool**. A cached thread pool creates new threads as needed, but will reuse previously constructed threads when they are available. This pool is suitable in scenarios that execute many short-lived asynchronous tasks. The way Slice uses the thread pool to execute database operations is akin to such scenario and hence `cached` is the default value for this plug-in property.

The `fixed` alias activates a **fixed thread pool**. The fixed thread pool can be further parameterized with `CorePoolSize`, `MaximumPoolSize`, `KeepAliveTime` and `RejectedExecutionHandler`. The meaning of these parameters are described in **JavaDoc**. The users can exercise finer control on thread pool behavior via these parameters. By default, the core pool size is 10, maximum pool size is also 10, keep alive time is 60 seconds and rejected execution is **aborted**.

Both of the pre-defined aliases can be parameterized with a fully-qualified class name that implements `java.util.concurrent.ThreadFactory` interface.

### 13.4.1.6. openjpa.slice.TransactionPolicy

---

This plug-in property determines the policy for transaction commit across multiple slices. The value of this property is a fully-qualified class name that implements `javax.transaction.TransactionManager` interface.

Three pre-defined policies can be chosen by their aliases namely `default`, `xa` and `jndi`.

The `default` policy employs a Transaction Manager that commits or rolls back transaction on individual slices *without* a two-phase commit protocol. It does *not* guarantee atomic nature of transaction across all the slices because if one or more slice fails to commit, there is no way to rollback the transaction on other slices that committed successfully.

The `xa` policy employs a Transaction Manager that that commits or rolls back transaction on individual slices using a two-phase commit protocol. The prerequisite to use this scheme is, of course, that all the slices must be configured to use XA-compliant JDBC driver.

The `jndi` policy employs a Transaction Manager by looking up the JNDI context. The prerequisite to use this transaction manager is, of course, that all the slices must be configured to use XA-compliant JDBC driver.

### Warning

This JNDI based policy is not available currently.

## 13.4.2. Per-Slice Properties

---

Any OpenJPA property can be configured for each individual slice. The property name is of the form `openjpa.slice.[Logical slice name].[OpenJPA Property Name]`. For example, `openjpa.slice.One.ConnectionURL` where `One` is the logical slice name and `ConnectionURL` is an OpenJPA property name.

If a property is not configured for a specific slice, then the value for the property equals to the corresponding `openjpa.*` property.

---

# Chapter 14. Third Party Integration

OpenJPA provides a number of mechanisms for integrating with third-party tools. The following chapter will illustrate these integration features.

## 14.1. Apache Ant

---

Ant is a very popular tool for building Java projects. It is similar to the `make` command, but is Java-centric and has more modern features. Ant is open source, and can be downloaded from Apache's Ant web page at <http://ant.apache.org/>. Ant has become the de-facto standard build tool for Java, and many commercial integrated development environments provide some support for using Ant build files. The remainder of this section assumes familiarity with writing Ant `build.xml` files.

OpenJPA provides pre-built Ant task definitions for all bundled tools:

- **Enhancer Task**
- **Application Identity Tool Task**
- **Mapping Tool Task**
- **Reverse Mapping Tool Task**
- **Schema Tool Task**

The source code for all the Ant tasks is provided with the distribution under the `src` directory. This allows you to customize various aspects of the Ant tasks in order to better integrate into your development environment.

### 14.1.1. Common Ant Configuration Options

---

All OpenJPA tasks accept a nested `config` element, which defines the configuration environment in which the specified task will run. The attributes for the `config` tag are defined by the **JDBCConfiguration** bean methods. Note that excluding the `config` element will cause the Ant task to use the default system configuration mechanism, such as the configuration defined in the `org.apache.openjpa.xml` file.

Following is an example of how to use the nested `config` tag in a `build.xml` file:

#### *Example 14.1. Using the <config> Ant Tag*

```
<mappingtool>
  <fileset dir="${basedir}">
    <include name="**/model/*.java" />
  </fileset>
  <config connectionUserName="scott" connectionPassword="tiger"
    connectionURL="jdbc:oracle:thin:@saturn:1521:solarsid"
    connectionDriverName="oracle.jdbc.driver.OracleDriver" />
</mappingtool>
```

It is also possible to specify a `properties` or `propertiesFile` attribute on the `config` tag, which will be used to locate a properties resource or file. The resource will be loaded relative to the current `CLASSPATH`.

#### *Example 14.2. Using the Properties Attribute of the <config> Tag*

---

```
<mappingtool>
  <fileset dir="${basedir}">
    <include name="**/model/*.java"/>
  </fileset>
  <config properties="openjpa-dev.xml"/>
</mappingtool>
```

### Example 14.3. Using the `PropertiesFile` Attribute of the `<config>` Tag

```
<mappingtool>
  <fileset dir="${basedir}">
    <include name="**/model/*.java"/>
  </fileset>
  <config propertiesFile="../conf/openjpa-dev.xml"/>
</mappingtool>
```

Tasks also accept a nested `classpath` element, which you can use in place of the default classpath. The `classpath` argument behaves the same as it does for Ant's standard `javac` element. It is sometimes the case that projects are compiled to a separate directory than the source tree. If the target path for compiled classes is not included in the project's classpath, then a `classpath` element that includes the target class directory needs to be included so the enhancer and mapping tool can locate the relevant classes.

Following is an example of using a `classpath` tag:

### Example 14.4. Using the `<classpath>` Ant Tag

```
<openjpac>
  <fileset dir="${basedir}/source">
    <include name="**/model/*.java" />
  </fileset>
  <classpath>
    <pathelement location="${basedir}/classes"/>
    <pathelement location="${basedir}/source"/>
    <pathelement path="${java.class.path}"/>
  </classpath>
</openjpac>
```

Finally, tasks that invoke code-generation tools like the application identity tool and reverse mapping tool accept a nested `codeformat` element. See the code formatting documentation in [Section 2.3.1, “Code Formatting” \[209\]](#) for a list of code formatting attributes.

### Example 14.5. Using the `<codeformat>` Ant Tag

```
<reversmappingtool package="com.xyz.jdo" directory="${basedir}/src">
  <codeformat tabSpaces="4" spaceBeforeParen="true" braceOnSameLine="false"/>
</reversmappingtool>
```

## 14.1.2. Enhancer Ant Task

The enhancer task allows you to invoke the OpenJPA enhancer directly from within the Ant build process. The task's parameters correspond exactly to the long versions of the command-line arguments to the `org.apache.openjpa.enhance.PCEnhancer`.

The enhancer task accepts a nested `fileset` tag to specify the files that should be processed. You can specify `.java` or `.class` files. If you do not specify any files, the task will run on the classes listed in your `persistence.xml` or `openjpa.MetaDataFactory` property. You must, however, supply the classpath you wish the enhancer to run with. This classpath must include, at minimum, the openjpa jar(s), `persistence.xml` and the target classes.

Following is an example of using the enhancer task in a `build.xml` file:

### *Example 14.6. Invoking the Enhancer from Ant*

```
<target name="enhance">
  <!-- Define the classpath to include the necessary files. -->
  <!-- ex. openjpa jars, persistence.xml, orm.xml, and target classes -->
  <path id="jpa.enhancement.classpath">
    <!-- Assuming persistence.xml/orm.xml are in resources/META-INF -->
    <pathelement location="resources/" />

    <!-- Location of the .class files -->
    <pathelement location="bin/" />

    <!-- Add the openjpa jars -->
    <fileset dir=".">
      <include name="**/lib/*.jar" />
    </fileset>
  </path>

  <!-- define the openjpac task; this can be done at the top of the -->
  <!-- build.xml file, so it will be available for all targets -->
  <taskdef name="openjpac" classname="org.apache.openjpa.ant.PCEnhancerTask" classpathref="jpa.enhancement.classpath" />

  <!-- invoke enhancer on all .class files below the model directory -->
  <openjpac>
    <classpath refid="jpa.enhancement.classpath" />
    <fileset dir=".">
      <include name="**/model/*.class" />
    </fileset>
  </openjpac>
  <echo message="Enhancement complete" />
</target>
```

## 14.1.3. Application Identity Tool Ant Task

The application identity tool task allows you to invoke the application identity tool directly from within the Ant build process. The task's parameters correspond exactly to the long versions of the command-line arguments to the `org.apache.openjpa.enhance.ApplicationIdTool`.

The application identity tool task accepts a nested `fileset` tag to specify the files that should be processed. You can specify `.java` or `.class` files. If you do not specify any files, the task will run on the classes listed in your `persistence.xml` file or `openjpa.MetaDataFactory` property.

Following is an example of using the application identity tool task in a `build.xml` file:

### *Example 14.7. Invoking the Application Identity Tool from Ant*

```
<target name="appid">
  <!-- define the appidtool task; this can be done at the top of -->
  <!-- the build.xml file, so it will be available for all targets -->
  <taskdef name="appidtool" classname="org.apache.openjpa.ant.ApplicationIdToolTask"/>
```



```

<!-- invoke tool on all .jdo files below the current directory -->
<appidtool>
  <fileset dir=".">
    <include name="**/model/*.java" />
  </fileset>
  <codeformat spaceBeforeParen="true" braceOnSameLine="false"/>
</appidtool>
</target>

```

## 14.1.4. Mapping Tool Ant Task

The mapping tool task allows you to directly invoke the mapping tool from within the Ant build process. It is useful for making sure that the database schema and object-relational mapping data is always synchronized with your persistent class definitions, without needing to remember to invoke the mapping tool manually. The task's parameters correspond exactly to the long versions of the command-line arguments to the `org.apache.openjpa.jdbc.meta.MappingTool`.

The mapping tool task accepts a nested `fileset` tag to specify the files that should be processed. You can specify `.java` or `.class` files. If you do not specify any files, the task will run on the classes listed in your `persistence.xml` file or `openjpa.MetaDataFactory` property.

Following is an example of a `build.xml` target that invokes the mapping tool:

### *Example 14.8. Invoking the Mapping Tool from Ant*

```

<target name="refresh">
  <!-- define the mappingtool task; this can be done at the top of -->
  <!-- the build.xml file, so it will be available for all targets -->
  <taskdef name="mappingtool" classname="org.apache.openjpa.jdbc.ant.MappingToolTask"/>

  <!-- add the schema components for all .jdo files below the -->
  <!-- current directory -->
  <mappingtool action="buildSchema">
    <fileset dir=".">
      <include name="**/*.jdo" />
    </fileset>
  </mappingtool>
</target>

```

## 14.1.5. Reverse Mapping Tool Ant Task

The reverse mapping tool task allows you to directly invoke the reverse mapping tool from within Ant. While many users will only run the reverse mapping process once, others will make it part of their build process. The task's parameters correspond exactly to the long versions of the command-line arguments to the `org.apache.openjpa.jdbc.meta.ReverseMappingTool`.

Following is an example of a `build.xml` target that invokes the reverse mapping tool:

### *Example 14.9. Invoking the Reverse Mapping Tool from Ant*

```

<target name="reversemap">
  <!-- define the reversemappingtool task; this can be done at the top of -->
  <!-- the build.xml file, so it will be available for all targets -->
  <taskdef name="reversemappingtool"
    classname="org.apache.openjpa.jdbc.ant.ReverseMappingToolTask"/>

  <!-- reverse map the entire database -->

```

```
<reversemappingtool package="com.xyz.model" directory="{basedir}/src"
  customizerProperties="{basedir}/conf/reverse.properties">
  <codeformat tabSpaces="4" spaceBeforeParen="true" braceOnSameLine="false"/>
</reversemappingtool>
</target>
```

## 14.1.6. Schema Tool Ant Task

The schema tool task allows you to directly invoke the schema tool from within the Ant build process. The task's parameters correspond exactly to the long versions of the command-line arguments to the `org.apache.openjpa.jdbc.schema.SchemaTool`.

Following is an example of a `build.xml` target that invokes the schema tool:

### *Example 14.10. Invoking the Schema Tool from Ant*

```
<target name="schema">
  <!-- define the schematool task; this can be done at the top of -->
  <!-- the build.xml file, so it will be available for all targets -->
  <taskdef name="schematool" classname="org.apache.openjpa.jdbc.ant.SchemaToolTask"/>

  <!-- add the schema components for all .schema files below the -->
  <!-- current directory -->
  <schematool action="add">
    <fileset dir=".">
      <include name="**/*.schema" />
    </fileset>
  </schematool>
</target>
```

## 14.2. Apache Commons DBCP

OpenJPA does not provide its own JDBC connection pooling, as this should already be supplied to applications running in a Java EE application server in container managed mode. For Java SE or applications running in application managed mode, the OpenJPA aggregate `openjpa-all.jar` artifact and the binary assembly contains copies of **Apache Commons DBCP**, which provides a robust connection pooling implementation.

### 14.2.1. Apache Commons DBCP Configuration Options

The **JDBC DataSource configuration options** that we will need to modify in order to use Apache Commons DBCP for connection pooling are:

```
connectionDriverName="org.apache.commons.dbcp.BasicDataSource"
connectionProperties="DriverClassName=<prior connectionDriverName>, ..."
```

Additional Commons DBCP arguments can be provided in the `connectionProperties` value, such as:

```
MaxActive=10,MaxIdle=5,MinIdle=2,MaxWait=60000
```

Please visit the Commons DBCP website for the entire list of **configuration options** and explanations.

***Example 14.11. Using Commons DBCP with Apache Derby***

For example, to use Commons DBCP with an Apache Derby database server, we would need to provide the following settings, as either settings in the persistence.xml or as system environment overrides:

```
<property name="openjpa.ConnectionDriverName" value="org.apache.commons.dbcp.BasicDataSource" />
<property name="openjpa.ConnectionProperties" value="DriverClassName=org.apache.derby.jdbc.EmbeddedDriver, Url=jdbc:derby://local1
```

Notice that we supplied Username and Password settings, which are required by Commons DBCP for connecting to a database over the network, but can be dummy values if database security is not enabled.

# Chapter 15. Optimization Guidelines

There are numerous techniques you can use in order to ensure that OpenJPA operates in the fastest and most efficient manner. Following are some guidelines. Each describes what impact it will have on performance and scalability. Note that general guidelines regarding performance or scalability issues are just that - guidelines. Depending on the particular characteristics of your application, the optimal settings may be considerably different than what is outlined below.

In the following table, each row is labeled with a list of italicized keywords. These keywords identify what characteristics the row in question may improve upon. Many of the rows are marked with one or both of the *performance* and *scalability* labels. It is important to bear in mind the differences between performance and scalability (for the most part, we are referring to system-wide scalability, and not necessarily only scalability within a single JVM). The performance-related hints will probably improve the performance of your application for a given user load, whereas the scalability-related hints will probably increase the total number of users that your application can service. Sometimes, increasing performance will decrease scalability, and vice versa. Typically, options that reduce the amount of work done on the database server will improve scalability, whereas those that push more work onto the server will have a negative impact on scalability.

**Table 15.1. Optimization Guidelines**

<b>Use a connection pool</b> <i>performance, scalability</i>	OpenJPA's built-in datasource does not perform connection pooling or prepared statement caching, but it can use Apache Commons DBCP for connection pooling if it is provided on the classpath. Check out the <b>DriverDataSource</b> section, which describes how to use and configure Commons DBCP. Also, you can manually plug in a third-party pooling datasource like <b>Apache Commons DBCP</b> , included in the binary distribution and openjpa-all artifact, which may drastically improve application performance.
<b>Optimize database indexes</b> <i>performance, scalability</i>	<p>The default set of indexes created by OpenJPA's mapping tool may not always be the most appropriate for your application. Manually setting indexes in your mapping metadata or manually manipulating database indexes to include frequently-queried fields (as well as dropping indexes on rarely-queried fields) can yield significant performance benefits.</p> <p>A database must do extra work on insert, update, and delete to maintain an index. This extra work will benefit selects with WHERE clauses, which will execute much faster when the terms in the WHERE clause are appropriately indexed. So, for a read-mostly application, appropriate indexing will slow down updates (which are rare) but greatly accelerate reads. This means that the system as a whole will be faster, and also that the database will experience less load, meaning that the system will be more scalable.</p> <p>Bear in mind that over-indexing is a bad thing, both for scalability and performance, especially for applications that perform lots of inserts, updates, or deletes.</p>
<b>JVM optimizations</b> <i>performance, reliability</i>	Manipulating various parameters of the Java Virtual Machine (such as hotspot compilation modes and the maximum memory) can result in performance improvements. For more details about optimizing the JVM execution environment, please see <a href="http://www.oracle.com/technetwork/java/hotspotfaq-138619.html">http://www.oracle.com/technetwork/java/hotspotfaq-138619.html</a> .
<b>Use the data cache</b> <i>performance, scalability</i>	Using OpenJPA's <b>data and query caching</b> features can often result in a dramatic improvement in performance. Additionally, these caches can significantly reduce the amount of load on the database, increasing the scalability characteristics of your application.
<b>Set LargeTransaction to true, or set PopulateDataCache to false</b> <i>performance vs. scalability</i>	<p>When using OpenJPA's <b>data caching</b> features in a transaction that will delete, modify, or create a very large number of objects you can set <code>LargeTransaction</code> to true and perform periodic flushes during your transaction to reduce its memory requirements. See the Javadoc: <b>OpenJPAEntityManager.setTrackChangesByType</b>. Note that transactions in large mode have to more aggressively flush items from the data cache.</p> <p>If your transaction will visit objects that you know are very unlikely to be accessed by other transactions, for example an exhaustive report run only once a month, you can turn off population</p>

	of the data cache so that the transaction doesn't fill the entire data cache with objects that won't be accessed again. Again, see the Javadoc: <b>OpenJPAEntityManager.setPopulateDataCache</b>
<p><b>Run the OpenJPA enhancer on your persistent classes, either at build-time or deploy-time.</b></p> <p><i>performance, scalability, memory footprint</i></p>	OpenJPA performs best when your persistent classes have been run through the OpenJPA post-compilation bytecode enhancer. When dealing with enhanced classes, OpenJPA can make a number of assumptions that reduce memory footprint and accelerate persistent data access. When evaluating OpenJPA's performance, build-time or deploy-time enhancement should be enabled. See <b>Section 5.2, “Enhancement”</b> [274] for details.
<p><b>Disable logging, performance tracking</b></p> <p><i>performance</i></p>	Developer options such as verbose logging and the JDBC performance tracker can result in serious performance hits for your application. Before evaluating OpenJPA's performance, these options should all be disabled.
<p><b>Set IgnoreChanges to true, or set FlushBeforeQueries to true</b></p> <p><i>performance vs. scalability</i></p>	<p>When both the <b>openjpa.IgnoreChanges</b> and <b>openjpa.FlushBeforeQueries</b> properties are set to false, OpenJPA needs to consider in-memory dirty instances during queries. This can sometimes result in OpenJPA needing to evaluate the entire extent objects in order to return the correct query results, which can have drastic performance consequences. If it is appropriate for your application, configuring <b>FlushBeforeQueries</b> to automatically flush before queries involving dirty objects will ensure that this never happens. Setting <b>IgnoreChanges</b> to false will result in a small performance hit even if <b>FlushBeforeQueries</b> is true, as incremental flushing is not as efficient overall as delaying all flushing to a single operation during commit.</p> <p>Setting <b>IgnoreChanges</b> to true will help performance, since dirty objects can be ignored for queries, meaning that incremental flushing or client-side processing is not necessary. It will also improve scalability, since overall database server usage is diminished. On the other hand, setting <b>IgnoreChanges</b> to false will have a negative impact on scalability, even when using automatic flushing before queries, since more operations will be performed on the database server.</p>
<p><b>Configure openjpa.ConnectionRetainMode appropriately</b></p> <p><i>performance vs. scalability</i></p>	<p>The <b>ConnectionRetainMode</b> configuration option controls when OpenJPA will obtain a <b>ConnectionRetainMode</b> how long it will hold that connection. The optimal settings for this option will vary considerably depending on the particular behavior of your application. You may even benefit from using different retain modes for different parts of your application.</p> <p>The default setting of on-demand minimizes the amount of time that OpenJPA holds onto a datastore connection. This is generally the best option from a scalability standpoint, as database resources are held for a minimal amount of time. However, if you are not using connection pooling, or if your <b>DataSource</b> is not efficient at managing its pool, then this default value could cause undesirable pool contention.</p>
<p><b>Use flat inheritance</b></p> <p><i>performance, scalability vs. disk space</i></p>	<p>Mapping inheritance hierarchies to a single database table is faster for most operations than other strategies employing multiple tables. If it is appropriate for your application, you should use this strategy whenever possible.</p> <p>However, this strategy will require more disk space on the database side. Disk space is relatively inexpensive, but if your object model is particularly large, it can become a factor.</p>
<p><b>High sequence increment</b></p> <p><i>performance, scalability</i></p>	For applications that perform large bulk inserts, the retrieval of sequence numbers can be a bottleneck. Increasing sequence allocation sizes can reduce or eliminate this bottleneck. In some cases, implementing your own sequence factory can further optimize sequence number retrieval.
<p><b>Use optimistic transactions</b></p> <p><i>performance, scalability</i></p>	Using datastore transactions translates into pessimistic database row locking, which can be a performance hit (depending on the database). If appropriate for your application, optimistic transactions are typically faster than datastore transactions.

	<p>Optimistic transactions provide the same transactional guarantees as datastore transactions, except that you must handle a potential optimistic verification exception at the end of a transaction instead of assuming that a transaction will successfully complete. In many applications, it is unlikely that different concurrent transactions will operate on the same set of data at the same time, so optimistic verification increases the concurrency, and therefore both the performance and scalability characteristics, of the application. A common approach to handling optimistic verification exceptions is to simply present the end user with the fact that concurrent modifications happened, and require that the user redo any work.</p>
<p><b>Use query aggregates and projections</b> <i>performance, scalability</i></p>	<p>Using aggregates to compute reporting data on the database server can drastically speed up queries. Similarly, using projections when you are interested in specific object fields or relations rather than the entire object state can reduce the amount of data OpenJPA must transfer from the database to your application.</p>
<p><b>Always close resources</b> <i>scalability</i></p>	<p>Under certain settings, <code>EntityManager</code>s, OpenJPA <code>Extent</code> iterators, and <code>Query</code> results may be backed by resources in the database.</p> <p>For example, if you have configured OpenJPA to use scrollable cursors and lazy object instantiation by default, each query result will hold open a <code>ResultSet</code> object, which, in turn, will hold open a <code>Statement</code> object (preventing it from being re-used). Garbage collection will clean up these resources, so it is never necessary to explicitly close them, but it is always faster if it is done at the application level.</p>
<p><b>Use detached state managers</b> <i>performance</i></p>	<p>Attaching and even persisting instances can be more efficient when your detached objects use detached state managers. By default, OpenJPA does not use detached state managers when serializing an instance across tiers. See <a href="#">Section 12.1.3, “Defining the Detached Object Graph” [365]</a> for how to force OpenJPA to use detached state managers across tiers, and for other options for more efficient attachment.</p> <p>The downside of using a detached state manager across tiers is that your enhanced persistent classes and the OpenJPA libraries must be available on the client tier.</p>
<p><b>Utilize the EntityManager cache</b> <i>performance, scalability</i></p>	<p>When possible and appropriate, re-using <code>EntityManager</code>s and setting the <code>RetainState</code> configuration option to <code>true</code> may result in significant performance gains, since the <code>EntityManager</code>'s built-in object cache will be used.</p>
<p><b>Enable multithreaded operation only when necessary</b> <i>performance</i></p>	<p>OpenJPA respects the <code>openjpa.Multithreaded</code> option in that it does not impose as much synchronization overhead for applications that do not set this value to <code>true</code>. If your application is guaranteed to only use single-threaded access to OpenJPA resources and persistent objects, leaving this option as <code>false</code> will reduce synchronization overhead, and may result in a modest performance increase.</p>
<p><b>Enable large data set handling</b> <i>performance, scalability</i></p>	<p>If you execute queries that return large numbers of objects or have relations (collections or maps) that are large, and if you often only access parts of these data sets, enabling <b>large result set handling</b> where appropriate can dramatically speed up your application, since OpenJPA will bring the data sets into memory from the database only as necessary.</p>
<p><b>Disable large data set handling</b> <i>performance, scalability</i></p>	<p>If you have enabled scrollable result sets and on-demand loading but you do not require it, consider disabling it again. Some JDBC drivers and databases (SQL Server for example) are much slower when used with scrolling result sets.</p>
<p><b>Use the DynamicSchemaFactory</b> <i>performance, validation</i></p>	<p>If you are using an <code>openjpa.jdbc.SchemaFactory</code> setting of something other than the default <code>dynamic</code>, consider switching back. While other factories can ensure that object-relational mapping information is valid when a persistent class is first used, this can be a slow process. Though the validation is only performed once for each class, switching back to the <code>DynamicSchemaFactory</code> can reduce the warm-up time for your application.</p>

<p><b>Do not use XA transactions</b></p> <p><i>performance, scalability</i></p>	<p><b>XA transactions</b> can be orders of magnitude slower than standard transactions. Unless distributed transaction functionality is required by your application, use standard transactions.</p> <p>Recall that XA transactions are distinct from managed transactions - managed transaction services such as that provided by EJB declarative transactions can be used both with XA and non-XA transactions. XA transactions should only be used when a given business transaction involves multiple different transactional resources (an Oracle database and an IBM transactional message queue, for example).</p>
<p><b>Use Sets instead of List/Collections</b></p> <p><i>performance, scalability</i></p>	<p>There is a small amount of extra overhead for OpenJPA to maintain collections where each element is not guaranteed to be unique. If your application does not require duplicates for a collection, you should always declare your fields to be of type <code>Set</code>, <code>SortedSet</code>, <code>HashSet</code>, or <code>TreeSet</code>.</p>
<p><b>Use query parameters instead of encoding search data in filter strings</b></p> <p><i>performance</i></p>	<p>If your queries depend on parameter data only known at runtime, you should use query parameters rather than dynamically building different query strings. OpenJPA performs aggressive caching of query compilation data, and the effectiveness of this cache is diminished if multiple query filters are used where a single one could have sufficed.</p>
<p><b>Tune your fetch groups appropriately</b></p> <p><i>performance, scalability</i></p>	<p>The <b>fetch groups</b> used when loading an object control how much data is eagerly loaded, and by extension, which fields must be lazily loaded at a future time. The ideal fetch group configuration loads all the data that is needed in one fetch, and no extra fields - this minimizes both the amount of data transferred from the database, and the number of trips to the database.</p> <p>If extra fields are specified in the fetch groups (in particular, large fields such as binary data, or relations to other persistence-capable objects), then network overhead (for the extra data) and database processing (for any necessary additional joins) will hurt your application's performance. If too few fields are specified in the fetch groups, then OpenJPA will have to make additional trips to the database to load additional fields as necessary.</p>
<p><b>Use eager fetching</b></p> <p><i>performance, scalability</i></p>	<p>Using <b>eager fetching</b> when loading subclass data or traversing relations for each instance in a large collection of results can speed up data loading by orders of magnitude.</p>
<p><b>Disable BrokerImpl finalization</b></p> <p><i>performance, scalability</i></p>	<p>Outside of a Java EE application server or other JPA persistence container, OpenJPA's EntityManagers use finalizers to ensure that resources get cleaned up. If you are properly managing your resources, this finalization is not necessary, and will introduce unneeded synchronization, leading to scalability problems. You can disable this protective behavior by setting the <code>openjpa.BrokerImpl</code> property to <code>non-finalizing</code>. See <b>Section 9.1.1, “Broker Finalization” [335]</b> for details.</p>
<p><b>Preload MetadataRepository</b></p> <p><i>scalability</i></p>	<p>By default, the <code>MetadataRepository</code> is lazily loaded which means that fair amounts of locking is used to ensure that metadata is processed properly. Enabling preloading allows OpenJPA to load metadata upfront and remove locking. See <b>Section 6.2, “Metadata Repository” [297]</b> for details.</p>



---

# Chapter 16. Instrumentation

OpenJPA provides the ability to instrument various aspects of runtime operation. Instrumentation involves an instrumentation provider for base instrumentation capabilities and instruments for instrumenting various aspects of OpenJPA. OpenJPA includes a default instrumentation provider for JMX Platform MBeans. MBean-based instruments are provided for the data cache, query cache, and query SQL cache. When enabled, JMX-based remote monitoring tools such as **JConsole** can be used to monitor various metrics tracked by OpenJPA's caches by accessing MBeans registered under domain `org.apache.openjpa`. Additionally, custom applications can gather metrics by using the JMX API to query OpenJPA's MBeans. The `openjpa-integration-jmx` integration module contains an example of how to access the cache MBeans within program code.

## 16.1. Configuration

---

Instrumentation is enabled using the `openjpa.Instrumentation` configuration property. The base value is the instrumentation provider. The alias "jmx" enables the JMX Platform MBean provider. Instruments are specified on the `Instrument` attribute of the provider. Multiple instruments can be specified by enclosing the value in single quotes and specifying each instrument or instrument alias as a comma separated list. For example:

```
<!-- Enable caches and cache statistics -->
<property name="openjpa.DataCache" value="true(EnableStatistics=true)"/>
<property name="openjpa.QueryCache" value="true(EnableStatistics=true)"/>
<property name="openjpa.jdbc.QuerySQLCache" value="true(EnableStatistics=true)"/>

<!-- Enable jmx provider and instruments for Data, Query, and QuerySQL caches -->
<property name="openjpa.Instrumentation" value="jmx(Instrument='DataCache,QueryCache,QuerySQLCache')"/>
```

### 16.1.1. JMX Platform MBean Enablement

---

The built-in JMX Platform MBean provider can be used to monitor OpenJPA runtime information out-of-band. This provider is based upon the Platform MBean support included in the JDK. The JDK provides options for enabling secure connectivity and authentication. These options require additional configuration options and may require encryption keys to be installed on the local and remote systems. To enable simple, non-secure, non-authenticated monitoring of your application, specify the `-Dcom.sun.management.jmxremote.authenticate=false` and `-Dcom.sun.management.jmxremote.ssl=false` directives on the java command line invocation. To enable remote instrumentation on a specific port, specify which port to use on the directive `-Dcom.sun.management.jmxremote.port=<port>`. For example:

```
java -cp openjpa-all-2.2.0.jar:myApplication.jar -Dcom.sun.management.jmxremote.authenticate=false
-Dcom.sun.management.jmxremote.ssl=false -Dcom.sun.management.jmxremote.port=8888 com.my.app.Main
```

Additional information regarding the use and configuration of JMX Platform MBeans can be found in the [Java Management Extensions \(JMX\) Technology Overview](#).

## 16.2. Custom Providers and Instruments

---

OpenJPA includes built-in support for a JMX Platform MBean provider, but a custom instrumentation providers can be created by implementing the `InstrumentationProvider` interface or more simply by extending `AbstractInstrumentationProvider`. To use the custom instrumentation provider, include the class in your classpath and specify the class name as the base value on the `openjpa.Instrumentation` configuration property.



OpenJPA includes instruments for various caches, but you can also create your own instruments. To create a custom instrument you need to implement the **Instrument** interface or more simply extend **AbstractInstrument**. If you are building a Platform MBean JMX-based instrument this effort can be simplified by extending **JMXInstrument**. If you create your own custom provider, class name aliases can be registered within the provider to simplify configuration. For example, the instrument `com.my.app.MySQLInstrument` could be aliased as `MySQLInstrument` within custom provider `com.my.app.InstrumentationProvider`.

OpenJPA provides the ability to plug in custom instruments and gives instruments direct access to the configuration, but it is up to the creator of the instrument to add the internal monitoring. This often requires modifying or extending base OpenJPA classes (such as the Broker) or using a byte-code weaving tool such as AspectJ to produce aspect-based instruments.

Here is an example of how a custom instrumentation provider could be enabled with an instrument class aliased by the provider as `MySQLInstrument`.

```
<!-- Enable custom provider and instrument -->
<property name="openjpa.Instrumentation" value="com.my.app.InstrumentationProvider(Instrument='MySQLInstrument')"/>
```

---

## **Part 4. Appendices**

---

1. JPA Resources .....	393
2. Supported Databases .....	394
2.1. Overview .....	394
2.2. Verified Database Matrix .....	394
2.3. Compatible Database Matrix .....	394
2.4. Unverified Database Matrix .....	395
2.5. Apache Derby .....	396
2.6. Borland Interbase .....	396
2.6.1. Known issues with Interbase .....	396
2.7. JDataStore .....	396
2.8. IBM DB2 .....	396
2.8.1. Known issues with DB2 .....	396
2.9. Empress .....	397
2.9.1. Known issues with Empress .....	397
2.10. H2 Database Engine .....	397
2.10.1. Known issues with H2 Database Engine .....	397
2.11. Hypersonic .....	398
2.11.1. Known issues with Hypersonic .....	398
2.12. Firebird .....	398
2.12.1. Known issues with Firebird .....	398
2.13. Informix .....	398
2.13.1. Known issues with Informix .....	398
2.14. Ingres Database .....	398
2.14.1. Known issues with Ingres .....	399
2.15. InterSystems Cache .....	399
2.15.1. Known issues with InterSystems Cache .....	399
2.16. Microsoft Access .....	399
2.16.1. Known issues with Microsoft Access .....	399
2.17. Microsoft SQL Server .....	399
2.17.1. Known issues with SQL Server .....	399
2.18. Microsoft FoxPro .....	400
2.18.1. Known issues with Microsoft FoxPro .....	400
2.19. MySQL .....	400
2.19.1. Using Query Hints with MySQL .....	400
2.19.2. Known issues with MySQL .....	401
2.20. Oracle .....	401
2.20.1. Using Query Hints with Oracle .....	401
2.20.2. Known issues with Oracle .....	402
2.21. Pointbase .....	403
2.21.1. Known issues with Pointbase .....	403
2.22. PostgreSQL .....	403
2.22.1. Known issues with PostgreSQL .....	403
2.23. IBM solidDB .....	403
2.23.1. M-type tables vs. D-type tables .....	403
2.23.2. Concurrency control mechanism .....	404
2.24. Sybase Adaptive Server .....	404
2.24.1. Known issues with Sybase .....	404
3. Migration Considerations .....	405
3.1. OpenJPA 2.0.0 .....	405
3.1.1. Incompatibilities .....	405
3.1.1.1. getProperties() .....	405
3.1.1.2. Detach Behavior .....	405
3.1.1.3. Use of private persistent properties .....	405
3.1.1.4. Query.setParameter() .....	406

3.1.1.5. Serialization of Entities .....	406
3.1.1.6. openjpa.jdbc.QuerySQLCache .....	406
3.1.2. Disabling AutoOff Collection Tracking .....	406
3.1.3. Internal Behavioral Differences .....	406
3.1.3.1. PreUpdate/PostUpdate Life Cycle Callbacks .....	407
3.1.3.2. createEntityManagerFactory Exceptions .....	407
3.1.3.3. openjpa.QueryCache default .....	407
3.2. OpenJPA 2.2.0 .....	407
3.2.1. Incompatibilities .....	407
3.2.1.1. allocationSize Property of Sequence Generator .....	407
3.2.1.2. MetaModel Attributes for Arrays .....	408
3.2.1.3. supportsSetClob Property. ....	408
3.2.1.4. useNativeSequenceCache Property. ....	408
3.2.1.5. Cascade persist behavior .....	409
3.2.1.6. Life Cycle Event Manager Callback Behavior .....	409
3.2.1.7. shared-cache-mode Property .....	409
3.3. OpenJPA 2.3.0 .....	409
3.3.1. Incompatibilities .....	409
3.3.1.1. MappingTool Behavior for DB2 and Derby .....	409
3.3.1.2. RequiresSearchStringEscapeForLike DBDictionary Property .....	409
3.3.1.3. Return value of aggregate functions in SELECT clause .....	410

---

# Appendix 1. JPA Resources

- [Java Persistence 2.0 page](#)
- [Enterprise JavaBeans 3.1 page](#)
- [javax.persistence Javadoc](#)
- [OpenJPA Javadoc](#)

---

# Appendix 2. Supported Databases

## 2.1. Overview

---

The following appendix covers the database and JDBC driver versions that are known to work with OpenJPA, along with any database specific configuration parameters, known issues or limitations. The **Verified Database Matrix**, contains the list of databases and drivers that were tested extensively against this release of OpenJPA, while the **Compatible Database Matrix** contains the list of databases and drivers that were tested against prior releases or by OpenJPA users and may not support every feature of this release. The **Unverified Database Matrix** contains a list of databases which have been reported to work, but have not been tested by the development team.

## 2.2. Verified Database Matrix

---

Following is a table of the supported database and JDBC driver versions that have been verified against this version of OpenJPA. For the list of other databases and drivers that were tested in prior releases or by other OpenJPA users, but may not support every feature of this release, please refer to the **Compatible Database Matrix** section.

*Table 2.1. Supported Databases and JDBC Drivers*

Database Name	Database Version	JDBC Driver Name	JDBC Driver Version
Apache Derby	10.2.2.0, 10.3.3.0, 10.4.2.0, 10.5.3.0, 10.8.2.2	Apache Derby Embedded JDBC Driver	Same as Database Version
IBM DB2	8.1, 8.2, 9.1, 9.5, 9.7	IBM DB2 JDBC Universal Driver	3.50.152
IBM Informix Dynamic Server	10.00xC6, 11.10xC1, 11.5xC1	Informix JDBC driver	3.00 JC3, 3.10 JC1, 3.50 JC1
Microsoft SQL Server	2005 (9.00), 2008 (10.00)	Microsoft SQL Server JDBC Driver	1.2 or 2.0
MySQL	5.0.26, 5.1.6	MySQL Driver	5.1.6
Oracle	10g (10.1, 10.2), 11g (11.1, 11.2)	Oracle JDBC driver	11.2.0.1
PostgreSQL	8.3.5, 8.4	PostgreSQL Native Driver	8.3 JDBC3 (build 603), 8.4 JDBC3 (build 701)
IBM solidDB	6.5.0.0	solidDB JDBC Driver	2.0
Sybase Adaptive Server Enterprise	12.5, 15.0	jConnect	5.5, 6.0

## 2.3. Compatible Database Matrix

---

Following is a table of the database and JDBC driver versions that are compatible with OpenJPA. Some of these databases have been tested against this version of OpenJPA, while others were added or tested in prior releases and may not support all of the new features of this release. For the list of databases that have been fully tested against this release, please refer to the **Verified Database Matrix** section.

**Table 2.2. Compatible Databases and JDBC Drivers**

Database Name	Database Version	JDBC Driver Name	JDBC Driver Version
Apache Derby	10.1.2.1	Apache Derby Embedded JDBC Driver	10.1.2.1
Borland Interbase	7.1.0.202	Interclient	4.5.1
Borland JDataStore	6.0	Borland JDataStore	6.0
DB2	8.1	IBM DB2 JDBC Universal Driver	1.0.581, 2.10.72
Empress	8.62	Empress Category 2 JDBC Driver	8.62
Firebird	1.5, 2.0, 2.1	JayBird JCA/JDBC driver	2.1.6
H2 Database Engine	1.1.118	H2	Same as Database Version
Hypersonic Database Engine	1.8.0, 2.0.1 RC2	Hypersonic	Same as Database Version
Informix Dynamic Server	9.30.UC10, 9.4xC7	Informix JDBC driver	2.21.JC2, 3.00.JC3, 3.10.JC1
Ingres Database	9.2	Ingres JDBC Driver	9.2-3.4.8
InterSystems Cache	5.0	Cache JDBC Driver	5.0
Microsoft Access	9.0 (a.k.a. "2000")	DataDirect SequeLink	5.4.0038
Microsoft SQL Server	2000 (8.00)	Microsoft SQL Server JDBC Driver	1.2
Microsoft Visual FoxPro	7.0	DataDirect SequeLink	5.4.0038
MySQL	3.23.43-log	MySQL Driver	3.0.14
Oracle	8.1, 9.2	Oracle JDBC driver	10.2.0.1
Pointbase	4.4	Pointbase JDBC driver	4.4 (4.4)
PostgreSQL	7.2.1, 8.1.5	PostgreSQL Native Driver	8.1
IBM solidDB	6.5.0.0	solidDB JDBC Driver	2.0
Sybase Adaptive Server Enterprise	12.5	jConnect	5.5 (5.5)

## 2.4. Unverified Database Matrix

Following is a table of the database and JDBC driver versions that have been reported to work with OpenJPA by the community but have not been verified by the development team. In some cases this is a question of availability since the developers may not be able to obtain a license to test, or have experience configuring these databases. For the list of databases that have been fully tested against this release, please refer to the [Verified Database Matrix](#) section.

**Table 2.3. Unverified Databases and JDBC Drivers**

Database Name	Database Version	JDBC Driver Name	JDBC Driver Version
SAP MaxDB			

## 2.5. Apache Derby

---

### *Example 2.1. Example properties for Derby*

```
openjpa.ConnectionDriverName: org.apache.derby.jdbc.EmbeddedDriver
openjpa.ConnectionURL: jdbc:derby:DB_NAME;create=true
```

## 2.6. Borland Interbase

---

### *Example 2.2. Example properties for Interbase*

```
openjpa.ConnectionDriverName: interbase.interclient.Driver
openjpa.ConnectionURL: jdbc:interbase://SERVER_NAME:SERVER_PORT/DB_PATH
```

### 2.6.1. Known issues with Interbase

---

- Interbase does not support record locking, so datastore transactions cannot use the pessimistic lock manager.
- Interbase does not support the LOWER, SUBSTRING, or INSTR SQL functions.

## 2.7. JDataStore

---

### *Example 2.3. Example properties for JDataStore*

```
openjpa.ConnectionDriverName: com.borland.datastore.jdbc.DataStoreDriver
openjpa.ConnectionURL: jdbc:borland:dslocal:db-jdatastore.jds;create=true
```

## 2.8. IBM DB2

---

### *Example 2.4. Example properties for IBM DB2*

```
openjpa.ConnectionDriverName: com.ibm.db2.jcc.DB2Driver
openjpa.ConnectionURL: jdbc:db2://SERVER_NAME:SERVER_PORT/DB_NAME
```

### 2.8.1. Known issues with DB2

---

- Floats and doubles may lose precision when stored.
- Empty char values are stored as NULL.
- Fields of type BLOB and CLOB are limited to 1M. This number can be increased by extending DB2Dictionary.



- Explicit creation of indexes specified by the OpenJPA @Index annotation will fail on DB2 for iSeries if the default schema used by the JDBC driver does not exist. If a default schema is not specified on the connection, the iSeries will default to the user profile name. If a schema of that name does not exist, DB2 on iSeries will not create the schema, resulting in a failure when creating the index. The failure message will look similar to: "[SQL0204] USERNAME in QSYS type \*LIB not found." To work around this issue, specify a default schema on the JDBC URL or data source property and make sure that schema exists or create a schema which matches the user profile of the connection.
- Use of DB2 on z/OS with the IBM JCC driver requires the DESCSTAT subsystem parameter value to be set to 'YES'. If this parameter is set to 'NO', the mapping tool will fail with a persistence exception containing this text: "Invalid parameter: Unknown column name TABLE\_SCHEM". After changing the value of DESCSTAT, DB2 metadata tables must be recreated by running the DSNTIIMS job. See DB2 for z/OS documentation for additional information.
- When using LOBs with persistent attributes of a streaming data type (e.g. `java.io.InputStream`) in the case of very large LOB, DB2 JCC driver will automatically use progressive streaming to retrieve the LOB data. With progressive streaming, the inputStream retrieved must be fully materialized before the next iteration of call to `rs.next()`. By default this will result in a `LobClosedException` when OpenJPA processes the `InputStream`.

To work around this condition you may force `fullyMaterializedLobData` to true in the connection URL as shown below :

```
openjpa.ConnectionURL: jdbc:db2://localhost:50000/demodb:fullyMaterializeLobData=true;progressiveStreaming=NO
```

## 2.9. Empress

---

### *Example 2.5. Example properties for Empress*

```
openjpa.ConnectionDriverName: empress.jdbc.empressDriver
openjpa.ConnectionURL: jdbc:empress://SERVER=yourserver;PORT=6322;DATABASE=yourdb
```

### 2.9.1. Known issues with Empress

---

- Empress enforces pessimistic semantics (lock on read) when not using `AllowConcurrentRead` property (which bypasses row locking) for `EmpressDictionary`.
- Only the category 2 non-local driver is supported.

## 2.10. H2 Database Engine

---

### *Example 2.6. Example properties for H2 Database Engine*

```
openjpa.ConnectionDriverName: org.h2.Driver
openjpa.ConnectionURL: jdbc:h2:DB_NAME
```

### 2.10.1. Known issues with H2 Database Engine

---

- None

## 2.11. Hypersonic

---

### *Example 2.7. Example properties for Hypersonic*

```
openjpa.ConnectionDriverName: org.hsqldb.jdbcDriver
openjpa.ConnectionURL: jdbc:hsqldb:DB_NAME
```

### 2.11.1. Known issues with Hypersonic

---

- Hypersonic does not support pessimistic locking, so non-optimistic transactions will fail unless the `SimulateLocking` property is set for the `openjpa.jdbc.DBDictionary`

## 2.12. Firebird

---

### *Example 2.8. Example properties for Firebird*

```
openjpa.ConnectionDriverName: org.firebirdsql.jdbc.FBDriver
openjpa.ConnectionURL: jdbc:firebirdsql:SERVER_NAME/3050:DB_PATH_OR_ALIAS
```

### 2.12.1. Known issues with Firebird

---

- Firebird does not support auto-increment columns.
- In order to use many of JPQL functions with Firebird 1.5, Interbase UDFs have to be available in the database.

## 2.13. Informix

---

### *Example 2.9. Example properties for Informix Dynamic Server*

```
openjpa.ConnectionDriverName: com.informix.jdbc.IfxDriver
openjpa.ConnectionURL: \
  jdbc:informix-sqli://SERVER_NAME:SERVER_PORT/DB_NAME:INFORMIXSERVER=SERVER_ID
```

### 2.13.1. Known issues with Informix

---

- None

## 2.14. Ingres Database

---

### *Example 2.10. Example properties for Ingres*

```
openjpa.ConnectionDriverName: com.ingres.jdbc.IngresDriver
openjpa.ConnectionURL: \
```

```
jdbc:ingres://SERVER_NAME:DAS_SERVER_PORT/DB_NAME
```

## 2.14.1. Known issues with Ingres

- Databases must be created with the -n flag for Unicode compatibility in order to use LOBs.

## 2.15. InterSystems Cache

### *Example 2.11. Example properties for InterSystems Cache*

```
openjpa.ConnectionDriverName: com.intersys.jdbc.CacheDriver
openjpa.ConnectionURL: jdbc:Cache://SERVER_NAME:SERVER_PORT/DB_NAME
```

## 2.15.1. Known issues with InterSystems Cache

- Support for Cache is done via SQL access over JDBC, not through their object database APIs.

## 2.16. Microsoft Access

### *Example 2.12. Example properties for Microsoft Access*

```
openjpa.ConnectionDriverName: com.ddtek.jdbc.sequelink.SequeLinkDriver
openjpa.ConnectionURL: jdbc:sequelink://SERVER_NAME:SERVER_PORT
```

## 2.16.1. Known issues with Microsoft Access

- Using the Sun JDBC-ODBC bridge to connect is not supported.

## 2.17. Microsoft SQL Server

### *Example 2.13. Example properties for Microsoft SQL Server*

```
openjpa.ConnectionDriverName: com.microsoft.sqlserver.jdbc.SQLServerDriver
openjpa.ConnectionURL: \
    jdbc:sqlserver://SERVER_NAME:1433;DatabaseName=DB_NAME;selectMethod=cursor;sendStringParametersAsUnicode=false
```

## 2.17.1. Known issues with SQL Server

- When using a Microsoft SQL Server JDBC Driver v1.2 or earlier, the ConnectionURL must always contain the `selectMethod=cursor` string, which is necessary for the driver to properly support large result sets.
- When using a Microsoft SQL Server JDBC Driver v1.2 or earlier, the JDBC driver has bugs that manifest themselves when prepared statements are pooled. Please disable prepared statement pooling by including the `MaxCachedStatements=0` configuration property in your `org.apache.openjpa.ConnectionFactoryProperties`.

- SQL Server date fields are accurate only to the nearest 3 milliseconds, possibly resulting in precision loss in stored dates.
- Adding `sendStringParametersAsUnicode=false` to the `ConnectionURL` may significantly increase performance.
- The Microsoft SQL Server driver only emulates batch updates. The DataDirect JDBC driver has true support for batch updates, and may result in a significant performance gain.
- Floats and doubles may lose precision when stored.
- `TEXT` columns cannot be used in queries.
- When using a SQL Server instance that has been configured to be case-sensitive in schema names, you need to set the `"schemaCase=preserve"` parameter in the `openjpa.jdbc.DBDictionary` property.
- SQL Server 2005 does not support native sequences. If you would like to use generated values with SQL Server you should use `GenerationType.IDENTITY`, `GenerationType.TABLE`, or `GenerationType.AUTO`.
- The use of **LOB streaming** is limited. When reading LOB data from the database, the Microsoft SQL Server driver will actually load all the data into memory at the same time.
- The SQL Server 2008 `DATETIME2` data type supports 7 digits sub-second precision. When DataDirect JDBC driver is used with SQL Server 2008, `setTimestamp` method call with a `java.sql.Timestamp` argument of more than 3 digits precision in a prepared statement will result in truncation. This may cause loss of data precision or optimistic lock exception if an entity uses `Timestamp` type as version field.

## 2.18. Microsoft FoxPro

---

### *Example 2.14. Example properties for Microsoft FoxPro*

```
openjpa.ConnectionDriverName: com.ddtek.jdbc.sequelink.SequeLinkDriver
openjpa.ConnectionURL: jdbc:sequelink://SERVER_NAME:SERVER_PORT
```

### 2.18.1. Known issues with Microsoft FoxPro

---

- Using the Sun JDBC-ODBC bridge to connect is not supported.

## 2.19. MySQL

---

### *Example 2.15. Example properties for MySQL*

```
openjpa.ConnectionDriverName: com.mysql.jdbc.Driver
openjpa.ConnectionURL: jdbc:mysql://SERVER_NAME/DB_NAME
```

### 2.19.1. Using Query Hints with MySQL

---

MySQL has support for "query hints", which are keywords embedded in SQL that provide some hint for how the query should be executed. These hints are usually designed to provide suggestions to the MySQL query optimizer for how to efficiently perform

a certain query, and aren't typically needed for any but the most intensive queries. OpenJPA supports hints to be placed between `SELECT` keyword and column list.

**Example 2.16. Using MySQL Hints**

```
Query query = em.createQuery(...);
query.setHint("openjpa.hint.MySQLSelectHint", "SQL_NO_CACHE");
List results = query.getResultList();
```

## 2.19.2. Known issues with MySQL

- The default table types that MySQL uses do not support transactions, which will prevent OpenJPA from being able to roll back transactions. Use the `InnoDB` table type for any tables that OpenJPA will access.
- MySQL does not support sub-selects in versions prior to 4.1, so some operations (such as the `isEmpty()` method in a query) will fail due to this.
- Rollback due to database error or optimistic lock violation is not supported unless the table type is one of the MySQL transactional types. Explicit calls to `rollback()` before a transaction has been committed, however, are always supported.
- Floats and doubles may lose precision when stored in some datastores.
- When storing a field of type `java.math.BigDecimal`, some datastores will add extraneous trailing 0 characters, causing an equality mismatch between the field that is stored and the field that is retrieved.
- When using large result sets with MySQL there are a number of documented limitations. Please read the section titled "ResultSet" in the "MySQL JDBC API Implementation Notes". The net effect of these limitations is that you will have to read all of the rows of a result set (or close the connection) before you can issue any other queries on the connection, or an exception will be thrown. Setting `openjpa.FetchBatchSize` to any value greater than zero will enable streaming result sets.
- The use of **LOB streaming** is limited. When reading LOB data from the database, the MySQL JDBC driver will actually load all the data into memory at the same time.

## 2.20. Oracle

**Example 2.17. Example properties for Oracle**

```
openjpa.ConnectionDriverName: oracle.jdbc.driver.OracleDriver
openjpa.ConnectionURL: jdbc:oracle:thin:@SERVER_NAME:1521:DB_NAME
```

### 2.20.1. Using Query Hints with Oracle

Oracle has support for "query hints", which are formatted comments embedded in SQL that provide some hint for how the query should be executed. These hints are usually designed to provide suggestions to the Oracle query optimizer for how to efficiently perform a certain query, and aren't typically needed for any but the most intensive queries.

**Example 2.18. Using Oracle Hints**

```
Query query = em.createQuery(...);
query.setHint("openjpa.hint.OracleSelectHint", "/*+ first_rows(100) */");
List results = query.getResultList();
```

## 2.20.2. Known issues with Oracle

- The Oracle JDBC driver has significant differences between different versions. It is important to use the officially supported version of the drivers (10.2.0.1.0/11.2.0.x.0), which is backward compatible with previous versions of the Oracle server. It can be downloaded from <http://www.oracle.com/technetwork/database/features/jdbc/index-091264.html>.
- Empty string/char values are stored as NULL.
- Oracle corp's JDBC driver for Oracle has only limited support for batch updates. The result for OpenJPA is that batching of some statements may fail and in some cases, the exact object that failed an optimistic lock check cannot be determined. OpenJPA will throw an `OptimisticException` with more failed objects than actually failed. This situation may be resolved by disabling statement batching by setting the `batchLimit` value to zero or by using a more recent Oracle JDBC Driver (11.2.0.1) with batch support improvements. Attempting to resolve the issue with a more current driver is recommended since disabling statement batching can result in a decrease in performance.

### *Example 2.19. Property to disable statement batching for Oracle*

```
openjpa.jdbc.DBDictionary: oracle(batchLimit=0)
```

- Oracle cannot store numbers with more than 38 digits in numeric columns.
- Floats and doubles may lose precision when stored.
- CLOB columns cannot be used in queries.
- The use of LOBs with persistent attributes of a streaming data type (ex. `java.io.InputStream` or `java.io.Reader`) may require the same connection to be used over the life of the transaction or entity manager. If the same connection is not used for persistent operations a `java.io.IOException` with message `Closed Connection` may result. The OpenJPA property `openjpa.ConnectionRetainMode` can be used to control how OpenJPA uses datastore connections. See [Section 4.8, “Configuring the Use of JDBC Connections” \[262\]](#) for details.

### *Example 2.20. Property to retain connection over the lifetime of the entity manager*

```
openjpa.ConnectionRetainMode: always
```

- Mapping persistent attributes to **XML columns** requires a JDBC 4 compliant driver if XML strings are longer than 4000 bytes, as counted in database. Otherwise an `ORA-01461: can bind a LONG value only for insert into a LONG column` error may result.
- If Oracle dictionary property `MaxEmbeddedBlobSize` or `MaxEmbeddedClobSize` is set to some limit (i.e. not -1) and embedded collection with BLOB/CLOB attribute is used, a `org.apache.openjpa.persistence.ArgumentException: "x.y.z.EmbedOwner.embedCollection<element:class x.y.z.EmbedValue>" is mapped as embedded, but embedded field "x.y.z.EmbedOwner.embedCollection.x.y.z.EmbedValue.blob" is not embeddable. Embedded element/key/value types are limited to simple fields and direct relations to other persistent types` error may result. To overcome this limitation, either use

JDBC driver 11.2.0.x.0 (or later version) or set both `MaxEmbeddedBlobSize` and `MaxEmbeddedClobSize` properties to -1.

## 2.21. Pointbase

---

### *Example 2.21. Example properties for Pointbase*

```
openjpa.ConnectionDriverName: com.pointbase.jdbc.jdbcUniversalDriver
openjpa.ConnectionURL: \
  jdbc:pointbase:DB_NAME,database.home=pointbasedb,create=true,cache.size=10000,database.pagesize=30720
```

### 2.21.1. Known issues with Pointbase

---

- Fields of type BLOB and CLOB are limited to 1M. Set the `BlobTypeName` and/or `ClobTypeName` properties of the `openjpa.jdbc.DBDictionary` setting to override.

## 2.22. PostgreSQL

---

### *Example 2.22. Example properties for PostgreSQL*

```
openjpa.ConnectionDriverName: org.postgresql.Driver
openjpa.ConnectionURL: jdbc:postgresql://SERVER_NAME:5432/DB_NAME
```

### 2.22.1. Known issues with PostgreSQL

---

- Floats and doubles may lose precision when stored.
- PostgreSQL cannot store very low and very high dates.
- Empty string/char values are stored as NULL.
- Persistent fields of type `java.io.Reader` are not supported when using **LOB streaming**.

## 2.23. IBM solidDB

---

### *Example 2.23. Example properties for IBM solidDB*

```
openjpa.ConnectionDriverName: solid.jdbc.SolidDriver
openjpa.ConnectionURL: jdbc:solid://localhost:2315/dba/dba
```

### 2.23.1. M-type tables vs. D-type tables

---

IBM solidDB supports two types of tables: in-memory tables (M-tables) and on-disk tables (D-tables). Since cursor hold over commit can not apply to M-tables (which will cause SOLID Table Error 13187: The cursor cannot continue accessing M-

tables after the transaction has committed or aborted. The statement must be re-executed), the default OpenJPA tables are D-tables. One can set the whole server to disk-based mode by adding [General] DefaultStoreIsMemory=no in solid.ini. The table types can also be determined by setting OpenJPA property "openjpa.jdbc.DBDictionary" with value "storeIsMemory=true" or "storeIsMemory=false" in the persistence.xml. The "STORE MEMORY" and "STORE DISK" will be appended to the create table DDL, respectively.

## 2.23.2. Concurrency control mechanism

The default concurrency control mechanism depends on the table type: Disk-based tables (D-tables) are by default optimistic. Main-memory tables (M-tables) are always pessimistic. Since OpenJPA applications expects lock waits as usually is done with normal pessimistic databases, the server should be set to the pessimistic mode. The optimistic mode is about not waiting for the locks at all. That increases concurrency but requires more programming. The pessimistic mode with the READ COMMITTED isolation level (default) should get as much concurrency as one might need. The pessimistic locking mode can be set in solid.ini: [General] Pessimistic=yes One can override the locking mode on the per table base by setting OpenJPA property "openjpa.jdbc.DBDictionary" to value "lockingMode=PESSIMISTIC" in the persistence.xml. An extra SQL will be generated along with CREATE TABLE DDL: ALTER TABLE EX\_POBJECT SET PESSIMISTIC. The possible values for lockingMode is OPTIMISTIC/PESSIMISTIC.

## 2.24. Sybase Adaptive Server

### *Example 2.24. Example properties for Sybase*

```
openjpa.ConnectionDriverName: com.sybase.jdbc2.jdbc.SybDriver
openjpa.ConnectionURL: \
    jdbc:sybase:Tds:SERVER_NAME:4100/DB_NAME?ServiceName=DB_NAME&BE_AS_JDBC_COMPLIANT_AS_POSSIBLE=true
```

### 2.24.1. Known issues with Sybase

- The "DYNAMIC\_PREPARE" parameter of the Sybase JDBC driver cannot be used with OpenJPA.
- Datastore locking cannot be used when manipulating many-to-many relations using the default OpenJPA schema created by the schematool, unless an auto-increment primary key field is manually added to the table.
- Persisting a zero-length string results in a string with a single space character being returned from Sybase, Inc.'s JDBC driver.
- The BE\_AS\_JDBC\_COMPLIANT\_AS\_POSSIBLE is required in order to use datastore (pessimistic) locking. Failure to set this property may lead to obscure errors like "FOR UPDATE can not be used in a SELECT which is not part of the declaration of a cursor or which is not inside a stored procedure."
- Applications performing update/insert data of the BigDecimal Java type may fail with OptimisticException if the data exceeds the scale or precision of the column on Sybase. To avoid this problem, applications can specify the precision and scale for the numeric type by setting numericTypeName='NUMERIC(p,s)' for the column type mapped by the BigDecimal Java type. See [openjpa.jdbc.DBDictionary](#) for more detail. Alternatively, application can set the precision and scale using the standard Column annotation, described in [Section 13.3](#), "Column" [151].



---

# Appendix 3. Migration Considerations

## 3.1. OpenJPA 2.0.0

---

### 3.1.1. Incompatibilities

---

The following sections indicate changes that are incompatible between OpenJPA 1.x.x releases and the 2.0 release. Some may require application changes. Others can be remedied through the use of compatibility options. If your application uses a version 1.0 persistence.xml, compatibility options will be set appropriately to maintain backward compatibility. OpenJPA 2.0 applications using a version 2.0 persistence.xml and requiring OpenJPA 1.x.x compatibility may need to configure the appropriate compatibility options to get the desired behavior.

#### 3.1.1.1. getProperties()

---

The OpenJPAEntityManagerFactory interface getProperties() method was changed to return a Map instead of a Properties object. This change was made in order to support the getProperties() method defined in the JPA 2.0 specification.

#### 3.1.1.2. Detach Behavior

---

The detach behavior has changed in several ways:

- In the 1.x.x release, managed entities were flushed to the database as part of the detach operation. This is no longer done in 2.0.
- In the 1.x.x release, entities were copied and returned. In 2.0, for those methods that have return values, the original entities are returned.
- In the 1.x.x release, managed entities still exist in the persistent context. In 2.0, they are removed.
- In the 1.x.x release, the detach operation is recursively cascaded to all referenced entities. In 2.0, the detach operation is only cascaded to those entities for which Cascade=detach has been specified.

Applications that use a 1.0 persistence.xml will automatically maintain OpenJPA 1.x.x behavior. It is possible for a version 2.0 application to revert back to the 1.x.x behavior for some of these items by setting the openjpa.Compatibility property as follows:

```
CopyOnDetach=true  
FlushBeforeDetach=true  
CascadeWithDetach=true
```

In addition, a new method has been provided on the `OpenJPAEntityManager` interface to return a copy of the entity:

```
public <T> T detachCopy(T pc):
```

#### 3.1.1.3. Use of private persistent properties

---

In 1.x.x releases of OpenJPA, if property access was used, private properties were considered persistent. This is contrary to the JPA specification, which states that persistent properties must be public or protected. In OpenJPA 2.0 and later, private properties will not be persistent by default.

Applications that use a 1.0 persistence.xml will automatically maintain OpenJPA 1.x.x behavior. It is possible for a version 2.0 application to revert back to the 1.x.x behavior by setting the value of the `openjpa.Compatibility` property

`PrivatePersistentProperties` to `true`. If compile time enhancement is used, this property must be specified at the time of enhancement and at runtime.

### 3.1.1.4. `Query.setParameter()`

---

The `Query` interface `setParameter()` method behavior has changed to throw an `IllegalArgumentException` (as required by the JPA specification) if more parameter substitutions are supplied than defined in the `createQuery()`, `createNamedQuery()`, or `createNativeQuery()` invocation. OpenJPA 1.2.x and prior versions silently ignored these extraneous parameter substitutions and allowed the `Query` to be processed.

### 3.1.1.5. Serialization of Entities

---

In 1.x.x releases of OpenJPA, when an entity was serialized after calling `EntityManager.find()`, `detach()` or `detachAll()` then all [Section 5.6.4, “Proxies” \[284\]](#) references were removed as expected, but when the same entity instance was serialized after calling `EntityManager.clear()` the proxy classes were not removed.

This has two side-effects: when entities are remotored across JVM boundaries (RPC) or deserialized the OpenJPA runtime must be available on the classpath (both client and server containers); when entities are deserialized the OpenJPA runtime must be the exact same revision as used to serialize the entities due to the proxy classes using dynamically generated `serialVersionUID` values.

Starting with OpenJPA 2.0, this behavior has been modified, so that by default all proxies will be removed during serialization. See [Section 5.6.4.4, “Serialization” \[287\]](#) on how the behavior changes based on the `DetachedStateField` setting along with [Section 12.1.3.1, “Detached State” \[365\]](#) for more details on how to override the default `DetachedStateField` setting.

Applications that use a 1.0 `persistence.xml` will automatically maintain the old behavior. It is possible for a version 2.0 application to revert back to the prior 1.x.x behavior by setting the following `openjpa.Compatibility` property as follows:

```
IgnoreDetachedStateFieldForProxySerialization=true
```

### 3.1.1.6. `openjpa.jdbc.QuerySQLCache`

---

In prior 1.x.x releases, the `openjpa.jdbc.QuerySQLCache` configuration property for Prepared SQL Cache accepted value `all` to never drop items from the cache, but this option is no longer supported and will cause a `PersistenceException` with a root cause of a `ParseException` to be thrown. See [Section 10.3, “Prepared SQL Cache” \[360\]](#) for details on the available configuration values.

## 3.1.2. Disabling AutoOff Collection Tracking

---

The default behavior of OpenJPA in tracking collections is that if the number of modifications to the collection exceeds the current number of elements in collection then OpenJPA will disable tracking the collections. OpenJPA 2.0 added a compatibility property to disable turning off the collection tracking.

The behavior of Auto disabling of collection tracking can be avoided by setting the value of the `openjpa.Compatibility` property `autoOff` to `false`. The default behavior of auto disabling the collection tracking is not changed. But when the above property is set then the collection tracking will not be disabled automatically.

### 3.1.3. Internal Behavioral Differences

---

The following sections indicate internal changes between OpenJPA 1.x.x releases and the 2.0 release. As these are internal implementation specific behaviors not covered by the JPA specification, no changes should be required for applications that did not use or depend upon OpenJPA specific APIs or behavior.

### 3.1.3.1. PreUpdate/PostUpdate Life Cycle Callbacks

If an entity was updated between the `persist()` and `commit()` operations in OpenJPA 1.x, then any `PreUpdate` and `PostUpdate` life cycle callback methods would be executed. Starting in OpenJPA 1.3 and 2.0, these callbacks will not get executed.

The JPA 2.0 specification section on "Semantics of the Life Cycle Callback Methods for Entities" has been updated to include a Note that the callback behavior for updating an entity after the `persist` operation is implementation specific and should not be relied upon.

### 3.1.3.2. createEntityManagerFactory Exceptions

The JPA 2.0 specification section on "Bootstrapping in Java SE Environments" states that persistence providers must return null if they are not a qualified provider for the given persistence unit.

However, OpenJPA may throw a `RuntimeException` if an error occurs while trying to create a qualified persistence unit, like for invalid `openjpa.*` specific configuration settings or for schema validation failures.

If the Apache Geronimo JPA 2.0 Spec APIs are used, then any exceptions returned by a persistence provider will be wrapped within a `PersistenceException`. When the JPA 2.0 API reference implementation is used, any `RuntimeExceptions` will be returned to the calling application without being wrapped. Other JPA 2.0 API and implementation providers or versions may behave differently.

### 3.1.3.3. openjpa.QueryCache default

In previous releases, the default value for the `openjpa.QueryCache` property was `true` when the `openjpa.DataCache` was enabled. Depending on application characteristics, this default `QueryCache` enablement actually could negate much of the potential gains achieved by using the `DataCache`. Thus, the default value for the `openjpa.QueryCache` property is now `false`.

To re-enable the default `QueryCache` behavior, you need to include the following property in your `persistence.xml` configuration.

```
<property name="openjpa.QueryCache" value="true"/>
```

If your configuration had previously enabled the `QueryCache` explicitly, then you might have to include the `true` value into your configuration (if you relied on the previous default). Otherwise, your current `QueryCache` enablement will continue to work.

```
<property name="openjpa.QueryCache" value="true(CacheSize=1000, SoftReferenceSize=100)"/>
```

## 3.2. OpenJPA 2.2.0

### 3.2.1. Incompatibilities

The following sections indicate changes that are incompatible between OpenJPA 2.1.x releases and the 2.2.0 release.

#### 3.2.1.1. allocationSize Property of Sequence Generator

In previous releases, specifying the `allocationSize` property of **sequence generator** affected only sequence definition in the database. During schema creation, the `INCREMENT BY` clause of `CREATE SEQUENCE` statement always had a value of

1 and on DB2, Oracle and PostgreSQL databases a `CACHE` clause was added with the value of `allocationSize` property. Such a statement caused sequence values being cached in the database. Starting with OpenJPA 2.2.0, sequence values are cached in the JVM memory and the `allocationSize` property determines size of that cache. The `CACHE` clause is no longer used, instead the `INCREMENT BY` clause gets its value equal to the `allocationSize` property. Such a strategy reduces the number of database roundtrips required for retrieving sequence values considerably.

In order for the existing applications to work with OpenJPA 2.2.0, you have to manually recreate or redefine sequences, specifying the correct `INCREMENT BY` value and, possibly, correct initial sequence value. Note that the default value of the `allocationSize` property is 50 and that value is used if the property is not specified.

The requirement for sequence modification applies to all databases that support sequences, regardless of the `CACHE` clause being supported. The only exception is Firebird database - since with this database the increment step is determined during sequence value fetch, no migration activity is needed.

To maintain the old behavior of sequence generator in OpenJPA 2.2.0, you can:

- Set the `allocationSize` property value to 1.
- Additionally, if the `CACHE` clause has to be emitted in sequence definition, this can be accomplished by overriding the `DBDictionary.getCreateSequenceSQL` method.

### 3.2.1.2. MetaModel Attributes for Arrays

In previous releases OpenJPA's MetaModel implementation generated a `ListAttribute` for every array. This behavior is correct if the array is annotated as a `PersistentCollection`, but not correct for un-annotated arrays (e.g. `byte[]`, `char[]`). In OpenJPA 2.2.0 this behavior was corrected so that arrays which are not stored as `PersistentCollections` will use a `SingularAttribute` instead of a `ListAttribute`.

If your application uses the MetaModel API and your entities contain arrays of any of the following types: `byte[]`, `Byte[]`, `char[]`, `Character[]` and do not use the `@PersistentCollection` annotation with those fields you will need to update your application to use OpenJPA 2.2.0.

In order for the existing applications to work with OpenJPA you may:

- Regenerate the canonical metamodel classes
- Set the Compatibility property `UseListAttributeForArrays` to `true` in `persistence.xml`

```
<property name="openjpa.Compatibility" value="UseListAttributeForArrays=true"/>
```

### 3.2.1.3. supportsSetClob Property.

In OpenJPA 2.2.0, code was added to allow the setting of CLOB or XML data larger than 4000 bytes. This functionality was eventually back ported to previous releases, and enabled by the `supportsSetClob` property on the `OracleDictionary`. Setting this property has no effect in 2.2.0 and later releases and any occurrence of it should be removed.

### 3.2.1.4. useNativeSequenceCache Property.

In OpenJPA 2.2.0, code was added which changed the way sequences were generated, please see [Section 3.2.1.1, “allocationSize Property of Sequence Generator” \[407\]](#) for details. This functionality was eventually back ported to previous releases, and enabled by the `useNativeSequenceCache` property on the `DBDictionary`. Setting this property has no effect in 2.2.0 and later releases and any occurrence of it should be removed. If previous behavior is desired (i.e. `useNativeSequenceCache=true`), please see the details described in section [Section 3.2.1.1, “allocationSize Property of Sequence Generator” \[407\]](#).

### 3.2.1.5. Cascade persist behavior

In previous releases, OpenJPA would check the database for the existence of the related Entity before persisting the relationship to that Entity. This resulted in an extra Select being sent to the database. In 2.2.0, code was added so that when cascading a persist to a related Entity without persistence state, the persist (insert) will happen without first checking the database. This may result in an EntityExistsException if the related Entity already exists in the database. To revert this behavior to the previous release, set the value of the `openjpa.Compatibility` property `CheckDatabaseForCascadePersistToDetachedEntity` to `true`.

### 3.2.1.6. Life Cycle Event Manager Callback Behavior

Life cycle event manager is used to manage entity's life cycle event callback. In previous releases, Life cycle event manager is scoped to `EntityManagerFactory`. This means listeners registered to an individual `EntityManager` may get life cycle event callbacks for entity that it does not manage.

From 2.2.1 release, the default callback behavior of the life cycle event manager is changed to scope to each `EntityManager`. To revert this behavior to the previous release, set the value of the `openjpa.Compatibility` property `SingletonLifecycleEventManager` to `true`.

### 3.2.1.7. shared-cache-mode Property

In the previous release, when the `shared-cache-mode` is enabled and the `DataCache` property is not set or set to `false`, there will be no data caching.

From 2.2.2 release, the caching will be turned on if the `shared-cache-mode` is enabled. Please see the details described in section [Section 10.1.1.2, “Integration with JPA standard shared cache mode” \[351\]](#).

## 3.3. OpenJPA 2.3.0

### 3.3.1. Incompatibilities

The following sections indicate changes that are incompatible between OpenJPA 2.2.x releases and the 2.3.0 release.

#### 3.3.1.1. MappingTool Behavior for DB2 and Derby

In previous releases, the `MappingTool` mapped `java.math.BigDecimal` fields to the database type `DOUBLE`, and as such, ignored `column` and `precision` values that might have been specified via the `javax.persistence.Column` annotation.

From the 2.3.0 release, `java.math.BigDecimal` fields are now mapped to the database type `DECIMAL` and it is very likely that you will need to specify `column` and `precision` via the `javax.persistence.Column` annotation.

#### 3.3.1.2. RequiresSearchStringEscapeForLike DBDictionary Property

In previous releases, the default value for the property `RequiresSearchStringEscapeForLike` is `true` and caused the unexpected escape clause appended to the SQL statement. For example, user created a named query like this:

```
SELECT o.computerName FROM CompUser o WHERE o.name LIKE ?
```

At run time the following query is generated:

```
SELECT t0.computerName FROM CompUser t0 WHERE (t0.name LIKE ? ESCAPE '\')
```

ESCAPE '\' shouldn't be appended to the query.

From the 2.3.0 release, `RequiresSearchStringEscapeForLike` property is set to false by default. You can configure `RequiresSearchStringEscapeForLike` property to be true if the old behavior is desired.

### 3.3.1.3. Return value of aggregate functions in SELECT clause

---

The JPA specification states "If SUM, AVG, MAX, or MIN is used, and there are no values to which the aggregate function can be applied, the result of the aggregate function is NULL." Prior to this update, OpenJPA incorrectly returned 0 for SUM, AVG, MIN, and MAX when a state field being aggregated is numeric. This behavior affects both JPQL and Criteria queries. With this update, OpenJPA will return a null result value for these aggregate functions when a query returns no result.

To re-enable the prior behavior, you need to set the following persistence property in your persistence.xml or when creating an EntityManagerFactory.

```
<property name="openjpa.Compatibility" value="ReturnNullOnAggregateResult=false"/>
```