



OpenOffice.org 3

Getting Started Guide

Chapter 7 ***Getting Started with*** ***Draw***

Vector Drawing in OpenOffice.org

Copyright

This document is Copyright © 2005–2008 by its contributors as listed in the section titled **Authors**. You may distribute it and/or modify it under the terms of either the [GNU General Public License](#), version 3 or later, or the [Creative Commons Attribution License](#), version 3.0 or later.

All trademarks within this guide belong to their legitimate owners.

Authors

Agnes Belzunce
Chris Bonde
Daniel Carrera
Regina Henschel
Michel Piquier
Iain Roberts
Gary Schnabl
Alex Thurgood
Jim Taylor
Jean Hollis Weber
Linda Worthington

Feedback

Please direct any comments or suggestions about this document to:
authors@user-faq.openoffice.org

Publication date and software version

Published 13 October 2008. Based on OpenOffice.org 3.0.



*You can download
an editable version of this document from
<http://oooauthors.org/en/authors/userguide3/published/>*

Contents

Copyright.....	2
What is Draw?.....	5
The Draw workspace.....	5
Rulers.....	6
Status bar.....	7
Toolbars.....	7
Positioning objects with snap functions.....	12
Snap to grid.....	13
Showing the grid.....	13
Configuring the grid.....	13
Changing the color of the grid points.....	14
Positioning objects with helper lines.....	15
The basic drawing shapes.....	15
Drawing a straight line.....	15
Drawing an arrow.....	16
Drawing lines and arrows.....	17
Drawing a rectangle or square.....	17
Drawing a circle or ellipse.....	18
Drawing curves.....	18
Writing text.....	19
Gluepoints and connectors.....	20
Drawing geometric shapes.....	21
Selection modes.....	23
Changing the selection mode.....	24
Selecting objects.....	24
Direct selection.....	24
Selection by framing.....	24
Selecting hidden objects.....	24
Arranging objects.....	25
Selecting several objects.....	25

Moving and dynamically adjusting an object's size.....	26
Dynamic movement of objects.....	26
Dynamic size modification of objects.....	27
Rotation.....	27
Inclination and perspective.....	28
Editing objects.....	28
The context menu.....	29
Editing lines and borders.....	29
Common line properties.....	29
Drawing arrows.....	30
Customizing line and arrow styles.....	30
Editing the inside (fill) of an object.....	30
Adding a shadow.....	31
Adding transparency.....	31
Using styles.....	31
Special effects.....	31
Flip an object.....	31
Mirror copies.....	32
Distorting an image.....	32
Dynamic gradients.....	32
Duplication.....	33
Cross-fading.....	34
Combining multiple objects.....	34
Grouping by common selection.....	35
Maintaining groups and undoing groups.....	35
Combining objects.....	35
Aids for positioning objects.....	35
Editing pictures.....	36
Working with 3D objects.....	36
Inserting pictures from other sources.....	36
Exchanging objects with other programs.....	37

What is Draw?

Draw is a vector graphics drawing program. It offers a series of powerful tools that enable you to quickly create all sorts of graphics. Vector graphics store and display an image as vectors (two points and a line) rather than a collections of pixels (dots on the screen). Vector graphics allow for easier storage and scaling of the image.

Draw is perfectly integrated into the OpenOffice.org suite, and this makes exchanging graphics with all components of the suite very easy. For example, if you create an image in Draw, reusing it in a Writer document is as simple as copying and pasting. You can also work with drawings directly from within Writer and Impress, using a subset of the functions and tools from Draw.

Draw's functionality is very extensive and complete. Although it was not designed to rival high-end graphics applications, Draw possesses more functions than the majority of drawing tools that are integrated into office productivity suites.

A few examples of drawing functions might whet your appetite: layer management, magnetic grid point system, dimensions and measurement display, connectors for making organization charts, 3D functions enabling small three-dimensional drawings to be created (with texture and lighting effects), drawing and page style integration, and Bézier curves, to name a few.

This chapter introduces some of Draw's features, but it does not attempt to cover all of the them. See the *Draw Guide* and the application Help for more information.

The Draw workspace

The main components of the Draw workspace are shown in Figure 1.

You can surround the drawing area with toolbars and information areas. The number and position of the visible tools vary with the task at hand or user preferences. Therefore, your setup may appear a little different. For example, many people put the main Drawing toolbar on the left-hand side of the workspace, not at the bottom as shown here.

You can split drawings in Draw over several pages. Multipage drawings are used mainly for presentations. The *Pages* pane, on the left side of the Draw window in Figure 1 gives an overview of the pages that you create. If the Pages pane is not visible on your setup, you can enable it from the View menu (**View > Page Pane**).

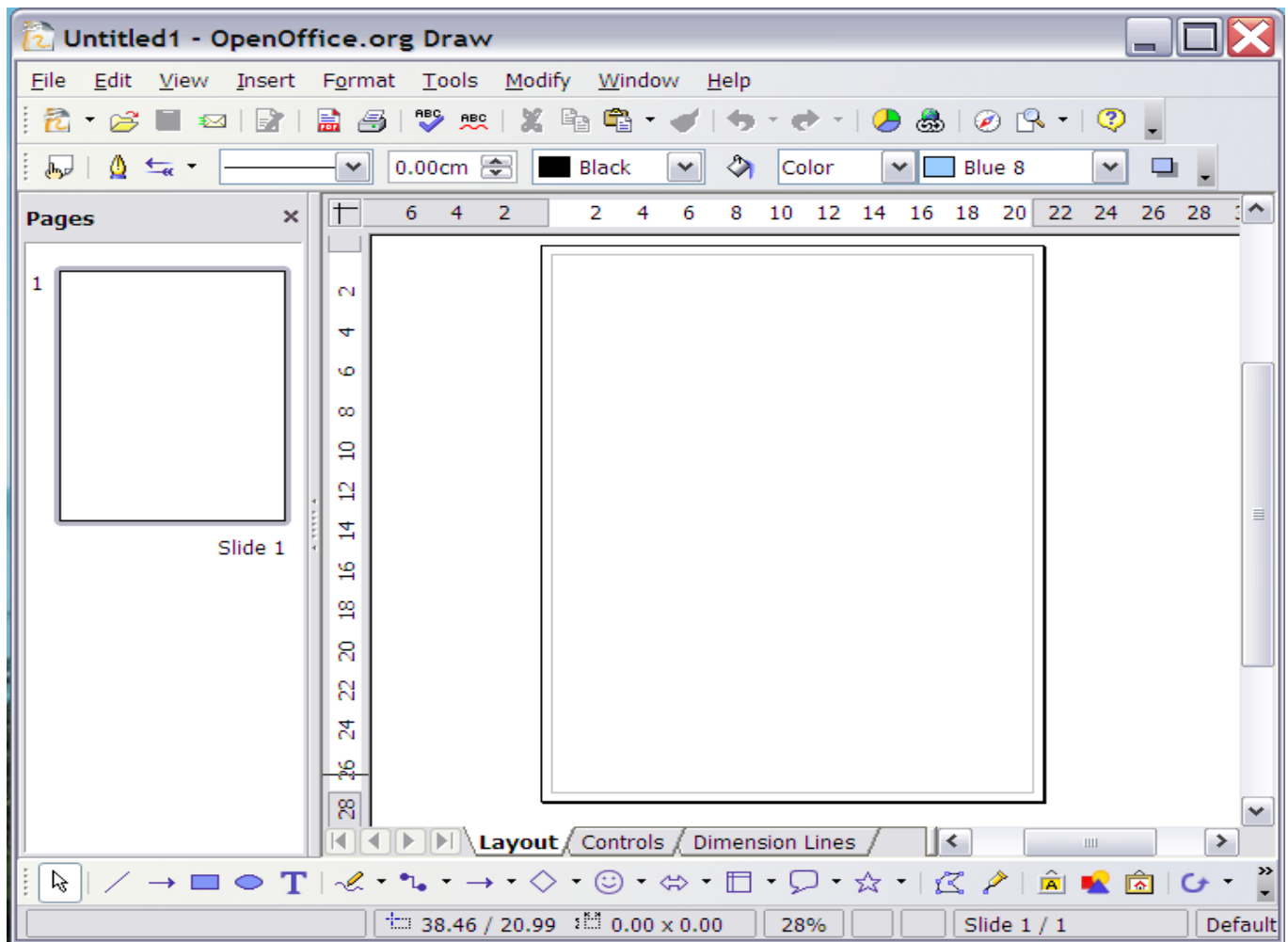

Figure 1. Initial Draw window

Rulers

You should see rulers (bars with numbers) on the upper and left-hand side of the workspace. These show the size of a selected object on the page (see the gray double lines, highlighted in Figure 2). When no object is selected, they show the location of the mouse pointer, which helps to accurately position drawing objects. You can also use the rulers to manage object handles and guide lines, making it easier to position objects. The page margins in the drawing area are also represented on the rulers. You can change the margins directly on the rulers by dragging them with the mouse.

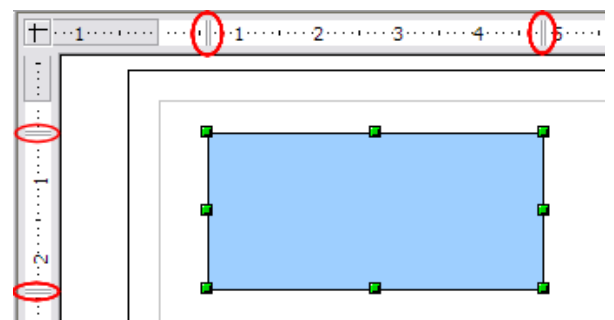

Figure 2: Rulers show the size of the selected object

To modify the units of measurement of the rulers, right-click on one of the rulers. The two rulers can have different units.

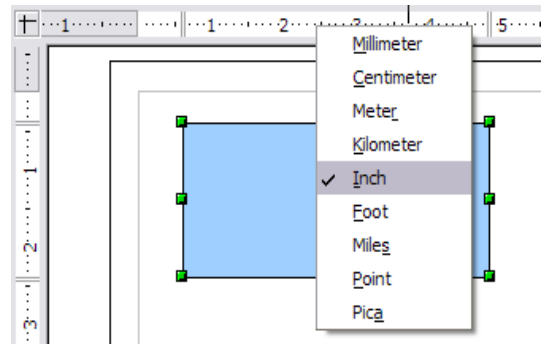

Figure 3. Ruler units

Status bar

The Status bar is located at the bottom of the workspace. The middle part of the Status bar shows Draw-specific fields, as identified in Figure 4.

For details on the contents and use of these fields, please refer to the *Draw Guide*.

Note

The sizes are given in the current measurement unit (not to be confused with the ruler units). This unit is defined in **Tools > Options > OpenOffice.org Draw > General**, where you can also change the scale of the page. Another way to change the scale is to double-click on the number shown in the status bar.

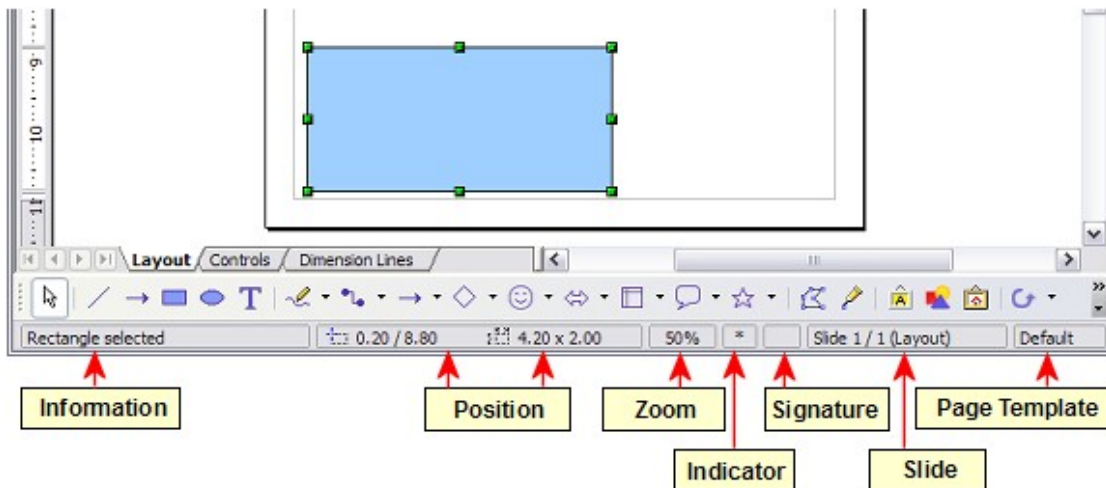

Figure 4: Items on the Draw status bar

Toolbars

The various Draw toolbars can be displayed or hidden according to your needs.

To display or hide the toolbars, click **View > Toolbars**. On the menu that appears, choose which toolbars you want to display.

You can also select the buttons that you wish to appear on the corresponding toolbar. On the **View > Toolbars** menu, select **Customize**, click on the **Toolbars** tab, select the toolbar you want to change, and then select the desired buttons for that toolbar.

Many toolbar buttons are marked with a small arrow beside the button. The arrow indicates that this button has additional functions. Click the arrow and a submenu or toolbar appears, showing its additional functions (see Figure 5). Most buttons marked with the small arrow can become *floating toolbars*.

To make a submenu into a floating toolbar, click the area at the top of the submenu, drag it across the screen, and then release the mouse button. Floating toolbars can be docked on an edge of the screen or within one of the existing toolbar areas at the top of the screen, as described in Chapter 1.

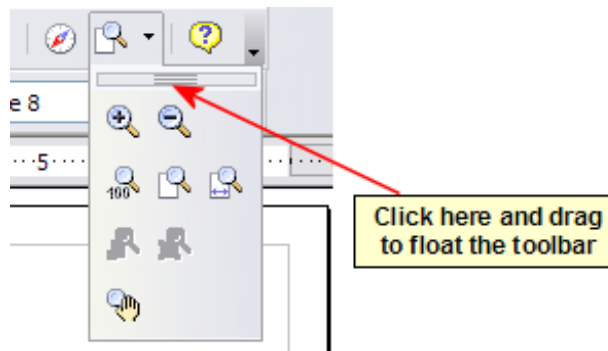

Figure 5. An arrow next to a button indicates additional functions

Click the arrow on the title bar of a floating toolbar to display additional functions (see Figure 6).

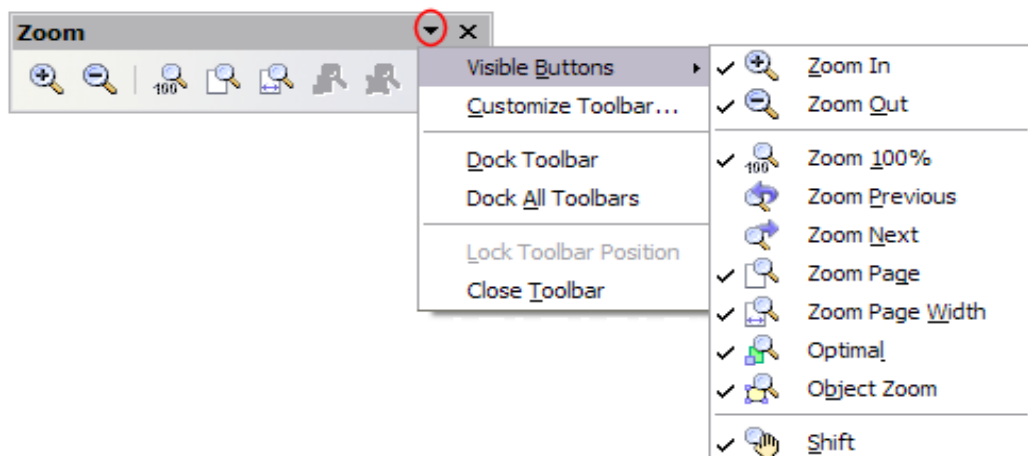
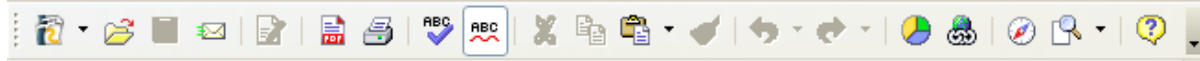

Figure 6. An arrow on a floating toolbar indicates additional functions

The tools available in the various toolbars are explained in the following sections. The appearance of the toolbar icons may vary with your operating system and the selection of icon size and style in **Tools > Options > OpenOffice.org > View**.

Standard toolbar

The Standard toolbar looks like this:



It is the same for all parts of OpenOffice.org.

Line and Filling toolbar

The Line and Filling toolbar lets you modify the main properties of a drawing object. See page 28 for details.



If the selected object is text, the toolbar changes to the one shown below, which is similar to the Formatting toolbar in Writer.



Drawing toolbar

The Drawing toolbar is the most important toolbar in Draw. It contains all the necessary functions for drawing various geometric and freehand shapes and organizing them on the page.



Color Bar

To display the Color Bar, use **View > Toolbars > Color Bar**. The toolbar then appears at the bottom of the workspace.



This toolbar lets you rapidly choose the color of the objects in your drawing. The first box in the panel corresponds to transparency (no color).

You can access several specialized color palettes in Draw, as well as change individual colors to your own taste. This is done using the Area dialog, reached by choosing **Format > Area** or the *pouring can* icon on the Line and Filling toolbar.

On the Area dialog, choose the tab marked **Colors**.

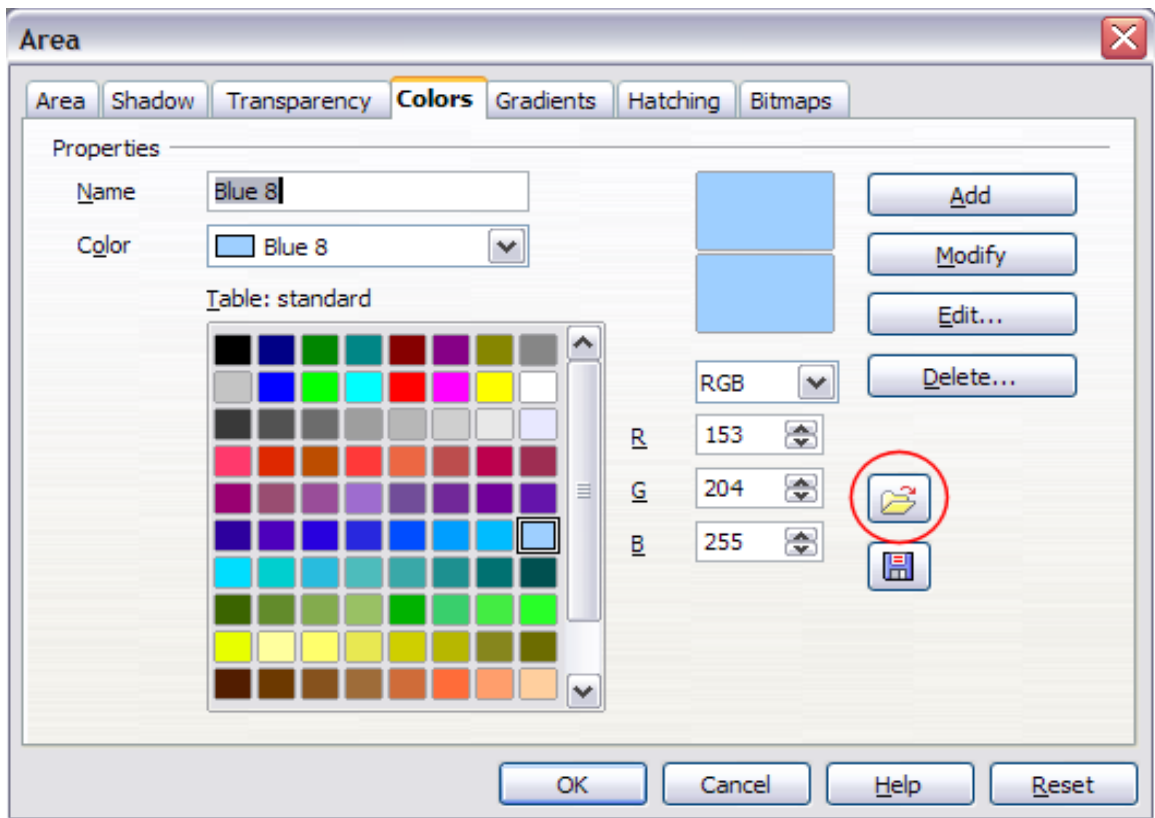

Figure 7. Changing the color palette

To load another palette, click on the **Load Color List** button (circled). The file selector dialog asks you to choose one of the standard OOo palettes (files bearing the file extension *.soc). For example, web.soc is a color palette that is adapted to creating drawings that are going to appear in Web pages. The colors will correctly display on workstations with screens displaying at least 256 colors.

The color selection box also lets you individually change any color by modifying the numerical values in the fields provided to the right of the color palette. You can use the color schemes known as CMYK (Cyan, Magenta, Yellow, Black), RGB (Red, Green, Blue) or HSB (Hue, Saturation, Brightness).

Clicking on the **Edit** button opens a special dialog to allow setting individual colors (see Figure 8). Many more input possibilities are available in this dialog.

In the lower area you can enter values in the RGB and CMYK models as well as the HSB (Hue, Saturation and Brightness) model.

The two color fields at lower right show the value of the color as selected (left) and the currently set value from the color value fields (right).

For a more detailed description of color palettes and their options, see Chapter 8 (Tips and Tricks) in the *Draw Guide*.

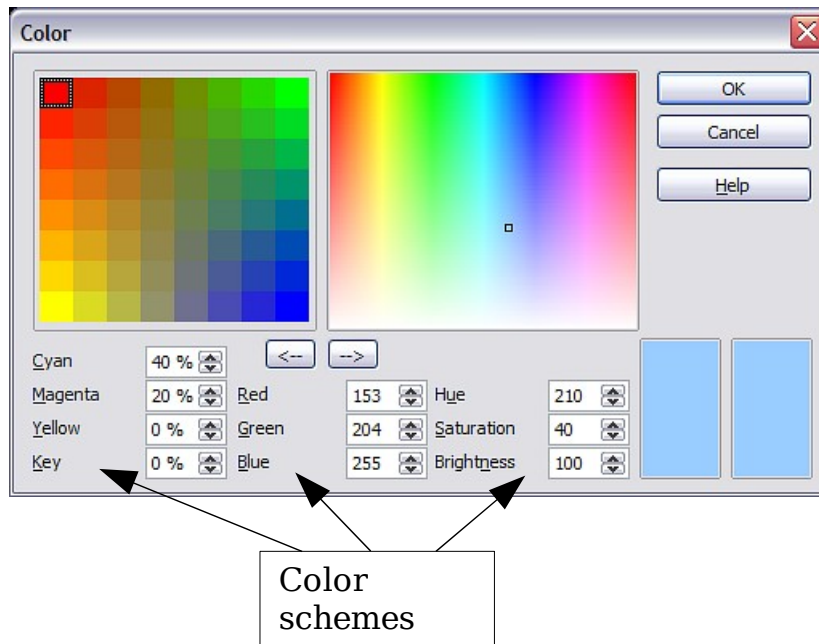

Figure 8. Defining color schemes

Options toolbar

The Options toolbar lets you activate or deactivate various drawing aids. The Options toolbar is not displayed by default. To display it, select **View > Toolbars > Options**. The most important options to learn when starting to work in Draw are enclosed in red. The functions of the various icons are described in Table 1.

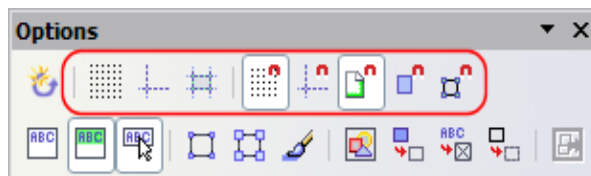









Figure 9: Options toolbar

Table 1: Functions on the Options toolbar

Icon	Function
	Rotation mode after clicking object
	Display (or hide) the grid
	Display (or hide) the guides
	Display (or hide) guides when moving
	Snap to grid
	Snap to guides
	Snap to page margins

Icon	Function
	Snap to object borders
	Snap to object points
	Allow quick editing
	Select text area only
	Double-click to edit text
	Simple handles
	Large handles
	Create object with attributes
	Picture placeholders
	Contour mode
	Text placeholders
	Line contour only
	Exit all groups

Positioning objects with snap functions

In Draw, objects can be positioned to grid points, to special snap points and lines, to object frames, to single object points, or to page edges. This function is known as *Snap*. In this manner objects can be very accurately positioned in a drawing.

If you want to use the snap function, it is much easier to work with the highest practical zoom value. It is possible to use two different snap functions at the same time, for example snap to a guide line and to the page edge. It is best, however, to activate only those functions that you really need.

This section describes the snap-to-grid function. For more information about this and the other snap functions, see Chapter 8 (Tips and Tricks) and Chapter 10 (Advanced Draw Techniques) in the *Draw Guide*.

Snap to grid

Use this function to move an object exactly to a grid point (see Figure 10). This function can be switched on and off with **View > Grid > Snap to Grid** and on the Options toolbar with the icon .

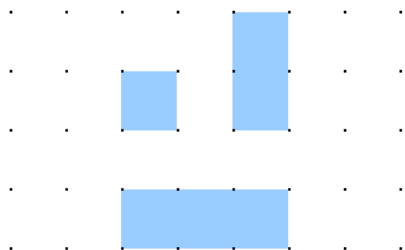



Figure 10: With snap to grid, objects align to the grid precisely.

Showing the grid

Make the grid visible under **View > Grid > Display Grid**.

Alternatively turn the grid on and off with the icon  on the Options toolbar.

Configuring the grid

The color, spacing, and resolution of the grid points can be individually chosen for each axis. The spacing between the lines is defined in the Grid options dialog under the Drawing area of the OOO options (**Tools > Options > OpenOffice.org Draw > Grid**). In the dialog shown in Figure 11, you can set the following parameters:

- Vertical and horizontal spacing of the dots in the grid. You can also change the unit of measurement used in the general Draw options (**Tools > Options > OpenOffice.org Draw > General**).
- The resolution is the size of the squares or rectangles in the grid. If the resolution is Horizontal 1cm, Vertical 2cm, the grid consists of rectangles 2cm high and 1cm wide.
- Subdivisions are additional points that appear along the sides of each rectangle or square in the grid. Objects snap to subdivisions as well as to the corners of the grid.
- The pixel (pix element) size of the snap area defines how close you need to bring an object to a snap point or line before it will snap to it.

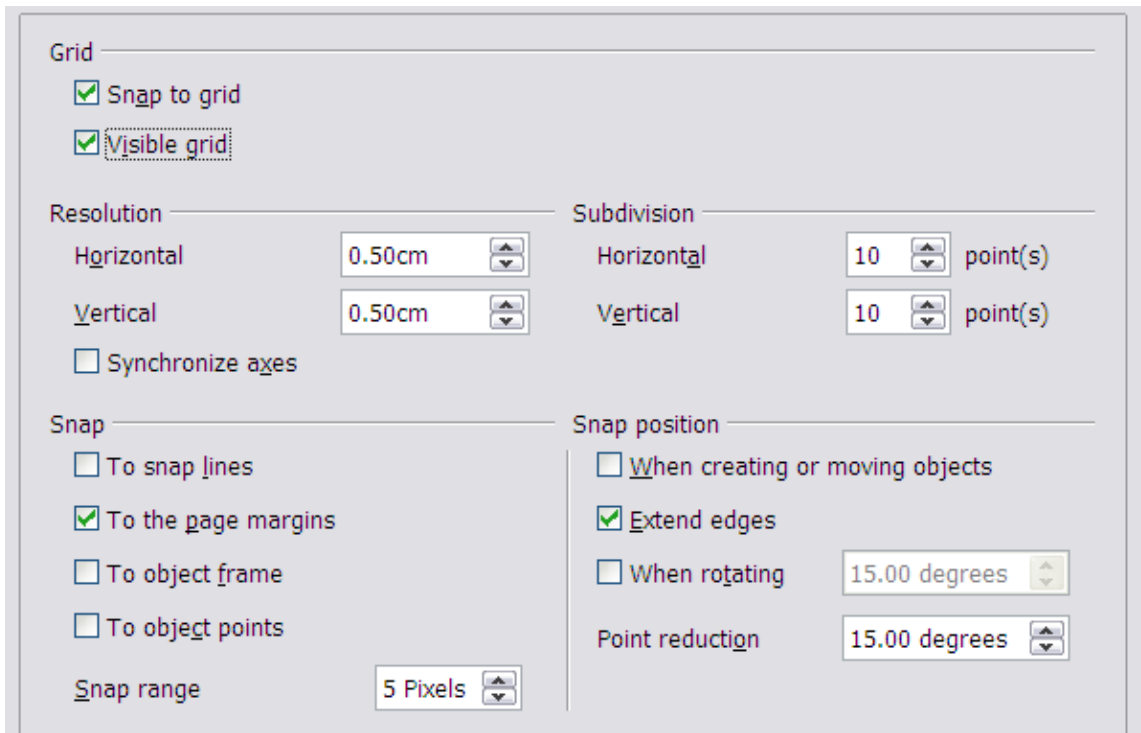

Figure 11. Setting grid options

Changing the color of the grid points

The default grid dots are light gray, which can be hard to see. To improve visibility, go to **Tools > Options**, then **OpenOffice.org > Appearance** (Figure 12).

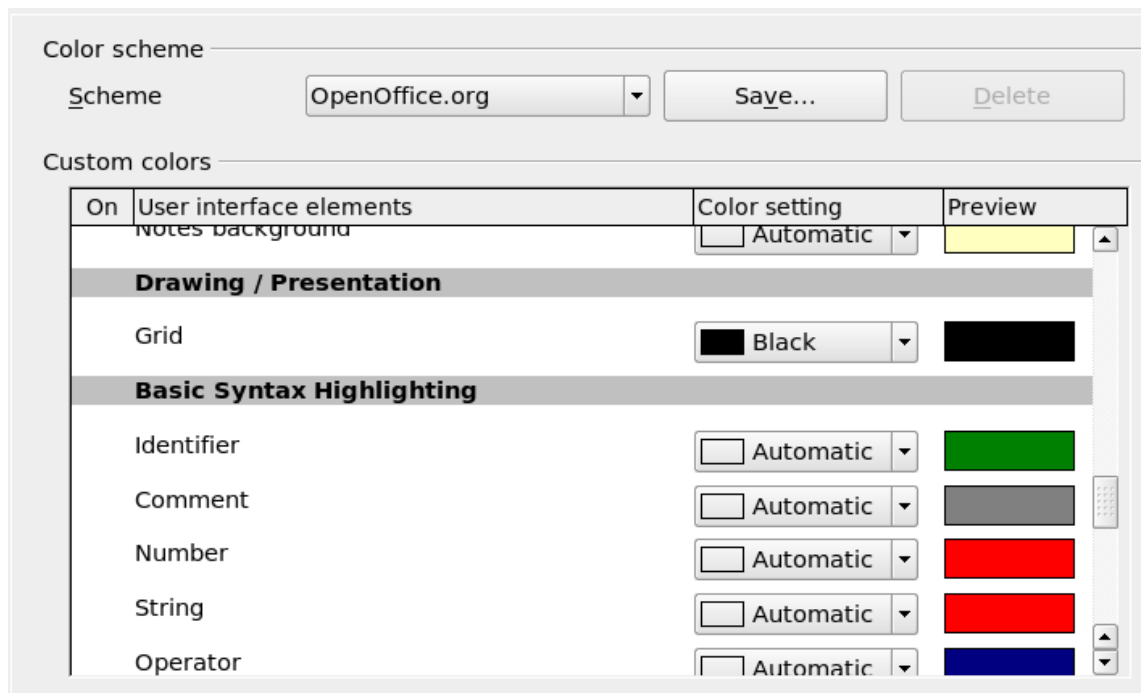



Figure 12: Changing the grid color

In the *Drawing / Presentation* section, you can change the color of the grid points. On the *Color Settings* pulldown menu, select a more suitable/visible color, for example black.

Positioning objects with helper lines

To simplify the positioning of objects it is possible to make visible guiding lines—extensions of the edges of the object—while it is being moved. These guiding lines have no snap function.

The guiding lines can be (de-)activated under **Tools > Options > OpenOffice.org Draw > View > Guides when moving**, or by clicking on the  icon on the *Options* toolbar.

The basic drawing shapes

Draw provides a wide range of shapes, located in palettes accessed from the Drawing Toolbar. This chapter describes only a few of the basic shapes; see the *Draw Guide* for a complete description of the shapes available. These shapes include rectangles and squares; circles, ellipses, and arcs; 3D objects; curves; lines and arrows; text; and connectors.

When you draw a basic shape or select one for editing, the *Info* field in the status bar changes to reflect the action taken: *Line created*, *Text frame xxyy selected*, and so on.

Figure 13 shows part of the Drawing toolbar with the icons needed in the following sections. The *Text* icon is also included.



Figure 13: Part of the Drawing toolbar

Drawing a straight line

Let's start by drawing the simplest of shapes: a straight line. Click on the **Line** icon  on the Drawing Toolbar and place the mouse pointer where you want to start the line. Drag the mouse while keeping the button pressed. Release the mouse button when you want to end the line.

A blue or green selection handle appears at each end of the line, showing that this is the currently selected object. The colors depend on the selection mode (green for simple selection and blue when in point

edit mode). This effect is easily apparent if on the Options toolbar both **Simple Handles** and **Large Handles** are switched on.

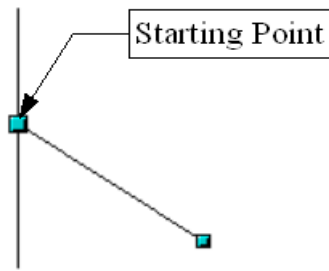

Figure 14: Drawing a straight line

Hold down the *Shift* key while drawing the line to restrict the angle of the line to a multiple of 45 degrees (0, 45, 90, 135, and so on).

Hold down the *Control* key (*Ctrl* in PCs) to snap the end of the line to the nearest grid point.

Note

The effect of the *Ctrl* key depends on the settings of the **Snap to Grid** option on the **View->Grid** menu:

Snap to Grid on: *Ctrl* deactivates the snap option for this activity.

Snap to Grid off: *Ctrl* activates the snap option for this activity.

The spacing (resolution) of the grid points can be adjusted under **Tools > Options > OpenOffice.org-Draw > Grid**. See also Chapter 8 (Tips and Tricks) in the *Draw Guide*.

Hold down the *Alt* key to extend the line symmetrically outward from the start point (the line extends to each side of the start point equally). This lets you draw straight lines by starting from the middle of the line.

The line just drawn has all the default attributes, such as color and line type. To change the line attributes, click on the line to select it and then use the tools in the Line and Filling toolbar; or for more control, right-click on the line and choose **Line** to open the Line dialog.

Drawing an arrow

Arrows are drawn like lines. Draw classifies arrows as a subgroup of lines: Lines with arrowheads. They are shown in the information field on the status bar only as lines. Click on the **Line Ends with Arrow** icon  to draw an arrow.

Drawing lines and arrows

Click on the small black triangle on the **Lines and Arrows**  icon to open a floating toolbar with ten tools for drawing lines and arrows (Figure 15). Alternatively, you can click directly on the symbol to repeat the last-used command chosen from this toolbar. In both cases, the last-used command will be stored on the toolbar to make it quicker to call it up again.

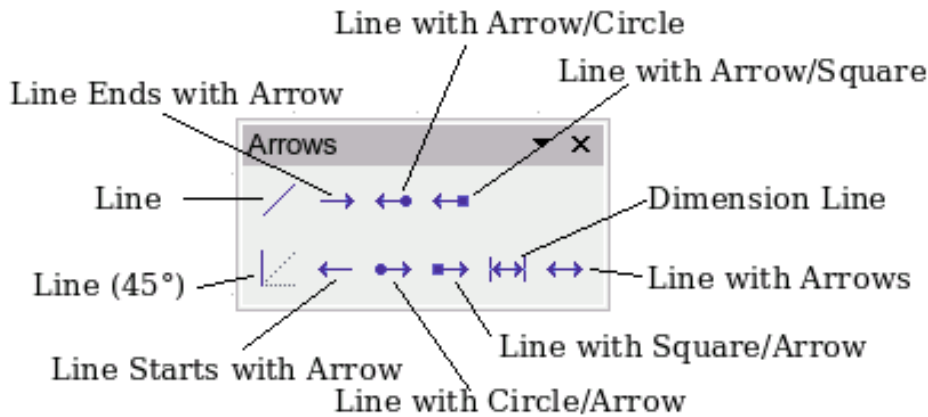



Figure 15: Lines and Arrows toolbar

Drawing a rectangle or square

Drawing rectangles is similar to drawing straight lines, except that you use the **Rectangle** icon  from the Drawing Toolbar. The (imaginary) line drawn with the mouse corresponds to the diagonal of the rectangle. In addition, the outline of the future rectangle changes shape as you drag the mouse around. The outline is shown as a dashed line until you release the mouse button, when the rectangle is drawn.

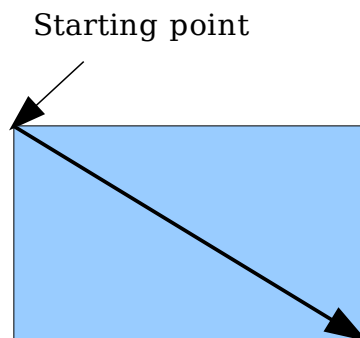



Figure 16: Drawing a rectangle

Hold down the *Shift* key to draw a square. Hold down the *Alt* key to draw a rectangle starting from its center. To combine the effects, hold down both the *Shift* and *Alt* keys simultaneously.

Drawing a circle or ellipse

To draw an ellipse (also called an oval) or a circle, use the Ellipse icon  from the Drawing Toolbar. (A circle is simply an ellipse where the two axes are the same length.) The ellipse drawn is the largest ellipse that would fit inside the (imaginary) rectangle drawn with the mouse.

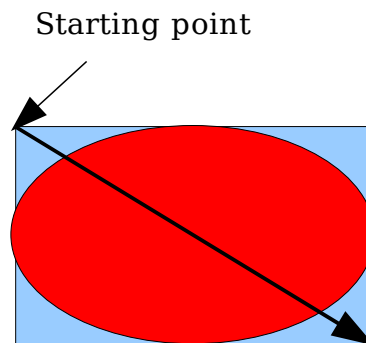

Figure 17: Drawing an ellipse

There are three other ways to draw an ellipse or circle:

- Hold down the *Shift* key while drawing to force the ellipse to be a circle.
- Hold down the *Alt* key to draw a symmetrical ellipse or circle from the center instead of dragging corner to corner.
- Hold down the *Control* key while drawing to snap the ellipse or circle to grid lines.

Note

If you first press and hold the *Control* key and then click on one of the icons (Line, Rectangle, Ellipse, or Text), an object is drawn automatically in the work area—the size, shape, and color are all standard values. These attributes can be changed later, if desired.

Drawing curves

The tools for drawing curves or polygons are on the toolbar that appears when you click the **Curve** icon  on the Drawing toolbar. This toolbar contains eight tools (Figure 18).

Note

Hovering the mouse over this icon gives a tooltip of *Curve*. If you convert the icon to a floating toolbar, however, the title is *Lines*, as shown in Figure 18.

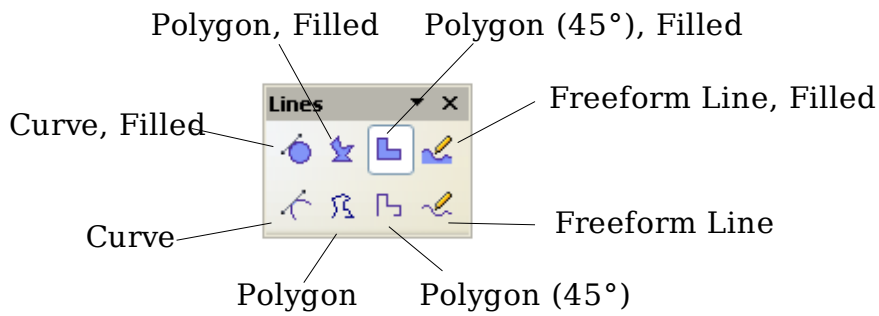

Figure 18: Floating Curves toolbar (incorrectly titled “Lines”)

If you move the mouse cursor over one of the icons, a tooltip pops up with a description of the function. For a more detailed description of the handling of Bézier curves (curves and filled curves), see Chapter 10 (Advanced Draw Techniques) in the *Draw Guide*.

Polygons

Draw the first line from the start point with the left mouse button held down. As soon as you release the mouse button, a first corner point is drawn, and you can move the mouse to see how the second line will look. Every mouse click sets another corner point. A double-click ends the drawing. A filled polygon automatically joins the last point to the first point to close off the figure and fills it with the current standard fill color. A polygon without filling will not be closed at the end of the drawing.

Polygon 45°

Just as with ordinary polygons, these will be formed from lines but with angles of 45 or 90 degrees between them.

Freeform Line

With this tool you can draw just like with a pencil. Press and hold the left mouse button and move the mouse. It is not necessary to end the drawing with a double-click. Just release the mouse button and the drawing is completed. If you have selected *Freeform Line, Filled*, the end point is joined automatically to the start point and the object is filled with the appropriate color.

Writing text

Use the Text tool **T** to write text and select the font, color, size, and other attributes. Click on an empty space in the workspace to write the text at that spot or drag an area to write inside the dragged frame. Press *Enter* to drop to the next line.

When you have finished typing text, click outside the text frame. Double-click on the text at any time to edit it.

When you type text, the upper toolbar includes the usual paragraph attributes: indents, first line, and tab stops.

You can change the style of all or part of the text. The Styles and Formatting window also works here (select **Format > Styles and Formatting** or press *F11* to launch), so you can create Graphics styles that you can reuse for other text frames. Graphics styles affect all of the text within a text frame. To style parts of the text, use direct formatting with the toolbar.

Text frames can also have fill colors, shadows, and other attributes, just like any other Draw object. You can rotate the frame and write the text at any angle. These options are available by right-clicking on the object.

Use the Callout tool, located on the Drawing toolbar, to create callouts (also known as captions or figure labels).

If you double-click on an object or press *F2* (or the **Text** icon in the Drawing toolbar) when an object is selected, text is written in the center of the object and remains within the object. Nearly any kind of object contains such an additional text element. These texts have slight differences to those in text frames concerning position and hyphenation.

For more about text, see Chapter 2 (Drawing Basic Shapes) and Chapter 10 (Advanced Draw Techniques) in the *Draw Guide*.

Gluepoints and connectors

All Draw objects have associated invisible *gluepoints*. Most objects have four gluepoints, as shown in Figure 19.

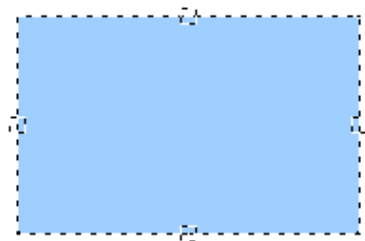

Figure 19: Four gluepoints

Gluepoints are different from handles (the small blue or green squares around an object). Use the handles to move or resize an object; use the gluepoints to attach connectors to an object.

You can add more gluepoints, and customize gluepoints, using the toolbar of the same name. Gluepoints become visible when you click

the **Gluepoints** icon  on the Drawing toolbar and then move the end of a connector over the object.

Connectors are a type of line or arrow whose ends dock to glue points on other objects. When you move the other object, the connector moves with it. Connectors are particularly useful for making organizational charts. You can reorganize the blocks of your chart and all the connected objects stay connected.

Figure 20 shows two Draw objects and a connector.

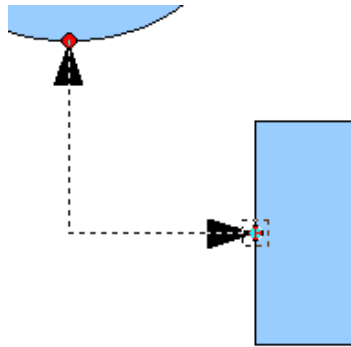



Figure 20: A connector between two objects

Draw has a range of advanced connector functions. You can change connector types using the context menu or by opening the floating Connectors toolbar (click on the **Connector** icon ). For more about connectors and gluepoints, see Chapter 9 (Organization Charts, Flow Diagrams, and More) in the *Draw Guide*.

Drawing geometric shapes

Geometric shapes include basic shapes, symbol shapes, block arrows, flowcharts, callouts, and stars.

Figure 21 shows part of the Drawing toolbar with the icons necessary for the following sections. They open floating toolbars with the relevant work tools. The use of all these tools is similar to that of the Rectangle tool, even though they produce different geometric shapes.

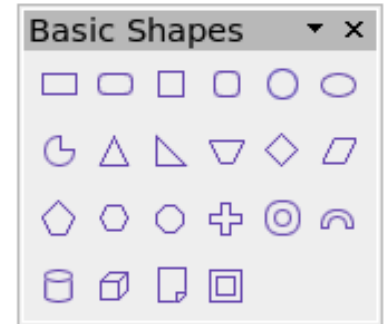

Figure 21: Part of the main Drawing toolbar

Basic shapes

The **Basic Shapes** icon  makes available the range of tools for drawing basic shapes.

If you choose the rectangle tool from this toolbar, it looks the same as a rectangle drawn using the Rectangle tool on the Drawing toolbar. The only differences you will see are in the information field in the status bar.



Symbol shapes

The **Symbol Shapes** icon  brings you to an array of tools for drawing the various symbol shapes.

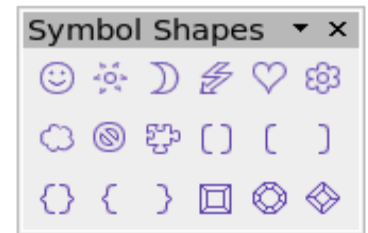

Block arrows

The **Block Arrows** icon  opens the Block Arrows toolbar.

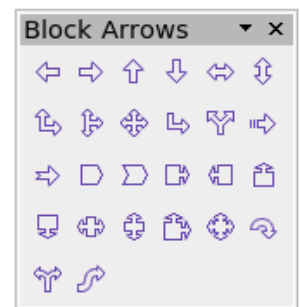

Flowcharts

The tools for drawing flowcharts are accessed by clicking on the **Flowcharts** icon .

The creation of flowcharts, organization charts, and similar planning tools are described in Chapter 9 (Organization Charts, Flow Diagrams, and More) in the *Draw Guide*.

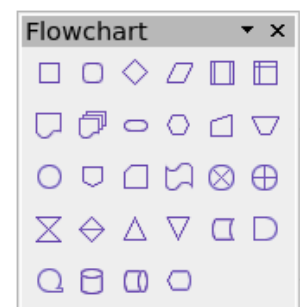

Callouts

Use the **Callouts** icon  to open the Callouts toolbar.



Stars and banners



These tools are associated with the **Stars** icon



You can add text to all these shapes. See Chapter 2 (Drawing Basic Shapes) and Chapter 10 (Advanced Draw Techniques) in the *Draw Guide* for details.

Selection modes

There are three selection modes: moving and changing size, rotating, and editing points.

The default mode for selecting objects depends on whether the **Points** button on the Drawing toolbar is active (appears lit)  or not inactive (appears dark or dimmed) .

In standard mode (when you begin a new drawing), the **Points** button is not active, and the default mode is for selections to be moved or changed in size; these selections are indicated by small green squares.

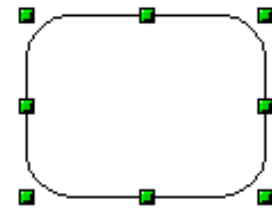

When the **Points** button is active, the default mode is for selections to be edited; these selections are indicated by blue squares. Some objects will have one or more extra handles, which are larger or colored differently. This is explained in more detail in the *Draw Guide*.

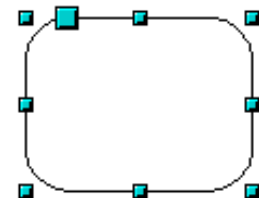

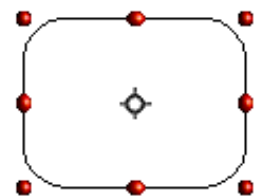

Selections for rotating objects are indicated by small red circles and a symbol representing the center of rotation. To choose these selections, click on the **Effects** drop-down button  from the Drawing toolbar.



Changing the selection mode

To go from one mode to another, you can do one of the following:

- Toggle the **Points** button on the Drawing toolbar to switch from the simple selection mode to the Points mode . You can also use the keyboard shortcut *F8* (Points).
- Choose the **Effects** drop-down button from the Drawing toolbar  to activate the Rotation mode for a selected object.
- If you often work in Rotation mode, you can choose the **Rotation Mode after Clicking Object** button  from the Options bar, you can cycle through normal and rotation modes just by clicking on the object. This can be more convenient than clicking the object, then clicking the **Rotate** button from the Drawing Toolbar.

Selecting objects

Direct selection

To select an object, the easiest way is to click directly on it. For objects that are not filled, click directly on the object's outline to select it.

Selection by framing

You can select several objects by using the mouse to drag a large rectangle around the objects, as shown. For this to work, the **Select**  icon on the Drawing toolbar must be active. Only objects that lie entirely within the rectangle are selected.

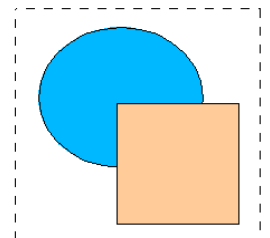

Selecting hidden objects

Even if objects are located behind others and not visible, they can still be selected. To select an object that is covered by another object, hold down the *Alt* key and click the object. To select an object that is covered by several objects, hold down the *Alt* key and click through the objects until you reach the required underlying object. To cycle through the objects in reverse order, hold down the *Alt+Shift* keys when you click. To help in making accurate selections, you can check the number and type of the selected objects, shown at the left of the status bar.

Note

There may be some variation in the use of the *Alt* key on different operating systems. In general the *Alt* key on a Windows computer functions as described above, but on a Linux system it usually does not. If the *Alt* key on your system does not operate as described above, use the *Tab* key method described below.

To select an object that is covered by another object using the keyboard, press *Tab* to cycle through the objects, stopping at the object you wish to select. To cycle through the objects in reverse order, press *Shift+Tab*. This may not be practical if you have a large number of objects in your drawing.

When you click on the selected object, its outline appears briefly through the objects on top of the selected object.

In the illustration to the right, the square located beneath the circle was selected in this way (the circle was made transparent in order to see the square).

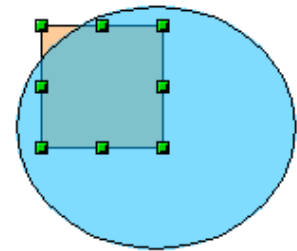

Arranging objects

In a complex drawing, you may have objects stacked up, one on top of the other, with the result that a particular object is hidden by one or more other objects above it. You can rearrange the stacking order of objects (move an object to the front or to the back of the stack) by selecting the object, clicking **Modify > Arrange** and selecting the appropriate **Bring Forward** or **Send Backward** option, or by right-clicking the object and selecting **Arrange** from the context menu, then selecting from the list of **Bring Forward** or **Send Backward** options.

On the Drawing toolbar, the Arrange tear-off menu on the  button contains the above options. A keyboard shortcut is *Shift+Ctrl++* to bring an object to the top, and *Shift+Ctrl+-* to send an object to the bottom.

Draw also provides tools for aligning multiple objects; details are given in the *Draw Guide*.

Selecting several objects

To select or deselect several objects one by one, press the *Shift* key and click on the various objects to be selected or deselected. One click on an object selects it; a second click deselects it.

Moving and dynamically adjusting an object's size

There are several ways of moving or changing the size of an object. The method described here will be called *dynamic* in the sense that it is carried out using the mouse.

When you dynamically change an object, remember to check the central area of the status bar at the bottom of your screen. This area shows detailed information about the ongoing manipulation. For example, during resizing, you will see the following information displayed. This information changes when the mouse is moved.

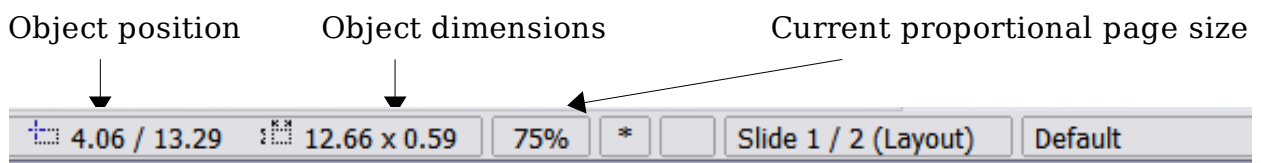

Dynamic movement of objects

To move an object, select it and then click within the object's border and hold down the left mouse button while moving the mouse. To drop the object at its new location, release the mouse button.

During movement, the shape of the object appears as dotted lines to help with repositioning.

If you have selected **Guides when moving** in **Tools > Options > OpenOffice.org Draw > View**, then during movement, dotted lines appear, to help with repositioning.

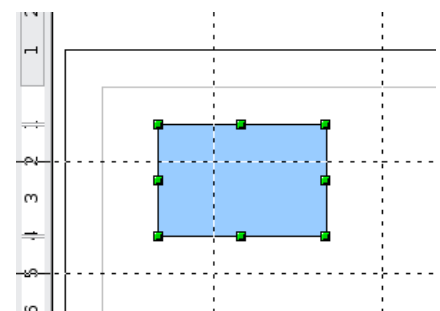
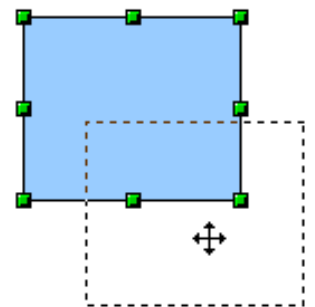

Dynamic size modification of objects

To change the size of an object (or group of selected objects) with the mouse, you need to move one of the handles located around the selection. As shown in the following illustration, the outline of the resulting new object appears as a dotted line.

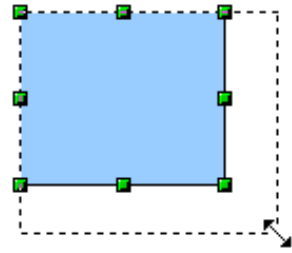

The results differ depending on which handle you use. If you choose a corner handle, you will resize the object along two axes at the same time. If you use a side handle, the objects will only be resized along one axis.

Note

If you press the *Shift* key at the same time as you carry out the resizing operation, the size change will be carried out symmetrically with respect to the two axes; this enables you to keep the aspect (height/length) ratio of the object.

Rotation

Rotating an object lets you move the object around an axis. To do this dynamically, use the red handles, as you do when changing the size of the object.

Note

Rotation works in a slightly different way for 3D objects because the rotation occurs in 3D space and not in one plane. See Chapter 7 (Working with 3D Objects) in the *Draw Guide* regarding rotation when Edit Points mode is active.

To rotate an object (or a group of objects), drag the red corner handle points of the selection with the mouse. The mouse cursor takes the shape of an arc of a circle with an arrow at each end. A dotted outline of the object being rotated appears and the current angle of rotation is dynamically shown in the status bar.

Rotations are made about an axis which is displayed as a small symbol. You can move the axis of rotation with the mouse, as shown in Figure 22.

If you hold down the *Shift* key during the rotation, the operation will be carried out in increments of 15°.

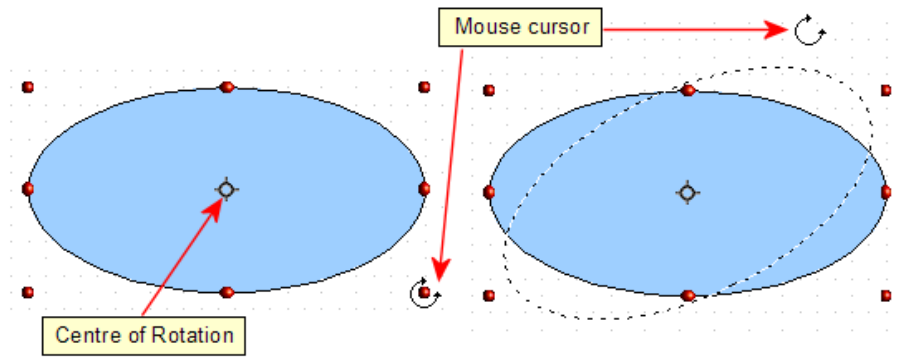

Figure 22: Rotating an object

Inclination and perspective

To slant or shear objects, use the red handles located at the midpoint of an edge of the selected objects. The mouse pointer changes to a \rightleftarrows when the pointer hovers over one of these midpoint handles. Not every object can be slanted—basic shapes can be rotated but not slanted.

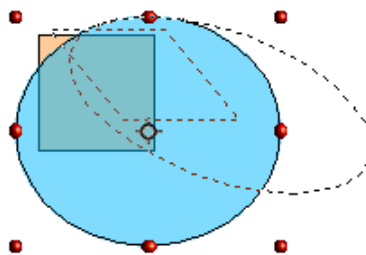

The slant axis is the point directly opposite the midpoint handle to be used for shearing the object. This point stays fixed in location; the other sides and edges move in relation to it as the mouse is dragged (make sure that the \rightleftarrows handle icon is showing before dragging).

As with rotation, you can set the inclination to occur as steps of 15° by pressing the *Shift* key while moving the handle.



Editing objects

To change an object's attributes (such as color, border width, among others) you can use the Line and Filling toolbar or the context menu.

If the Line and Filling toolbar (Figure 23) is not visible, you can display it using **View > Toolbars > Line and Filling**. From here you can edit the most common object attributes. You can also open the Line dialog by clicking on the Line  icon and the Area dialog by clicking on the Area  icon to see more options.



- | | | |
|--------------------------------|---------------------|---------------------------------|
| 1 Styles and Formatting | 4 Line Style | 7 Area |
| 2 Line | 5 Line Width | 8-9 Area Style / Filling |
| 3 Arrow Style | 6 Line Color | 10 Shadow |

Figure 23: Line and Filling toolbar

When you select text, this toolbar changes to show text formatting options (Figure 24).



Figure 24: Line and Filling toolbar (when text is selected)

The context menu

When an object is selected, you can right-click on the object to bring up a context menu, which provides additional access to the options shown above and another way to change an object's attributes. The entries with a small arrow on the right-hand side contain a submenu.

Editing lines and borders

Lines (like arrows) and the borders of an object are managed through the same dialog. An object's border is just another type of line.

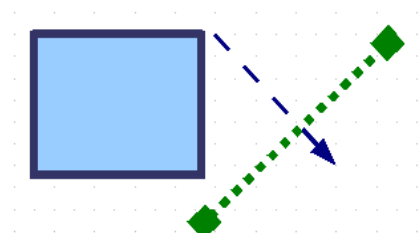

You can change some properties from the **Line and Filling** toolbar. To see more options, select the object and click on the Line  icon or right-click on the object and choose **Line** from the context menu. This opens the Line dialog.

Common line properties

In most cases the property you want to change is the line's style (solid, dashed, invisible, and so on), its color, or its width. These options are all available from the Line and Filling toolbar (Figure 23).

You can also edit these properties from the Line dialog, where you can also change the line's transparency. Figure 25 illustrates different degrees of transparency.

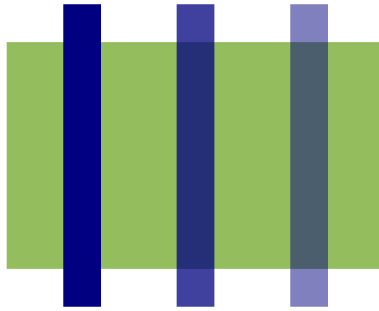



Figure 25: The vertical lines have different levels of transparency (0%, 25%, and 50%).

Drawing arrows

Arrowheads (and other line endings, usually referred to collectively as arrows) are a line property. Select a line and click on the **Arrow Style**  icon. This opens the Arrowheads menu.

Several types of arrowheads are available. Each end of the line can have a different arrowhead (or no arrowhead).

Arrowheads are only applicable to lines. They have no effect on an object's border.

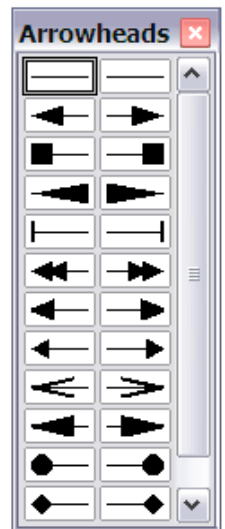

Customizing line and arrow styles

You can modify the line and arrow styles and create your own. See Chapter 4 (Changing Object Attributes) in the *Draw Guide* for details.

Editing the inside (fill) of an object

The OpenOffice.org term for the inside of an object is **Area fill**. The area fill of an object can be a uniform color, a gradient, a hatching, or a pattern from an image. It can be made partly or wholly transparent and can throw a shadow.

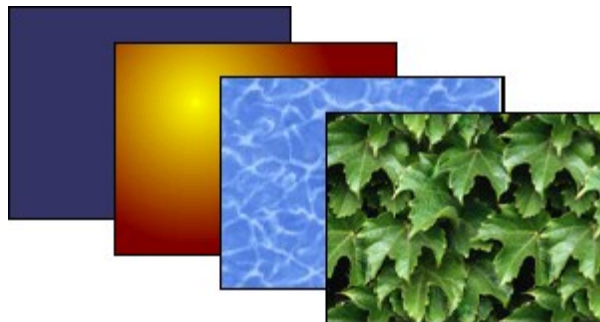

In most cases, you will choose one of the standard fill options, which are all available from the Line and Filling toolbar. You can also define your own area fills; see Chapter 4 of the *Draw Guide* for details.

Adding a shadow

In Draw, shadows are considered an area property. Click on the Shadow  icon on the **Line and Filling** toolbar.

You can customize the position, distance, color, and transparency of shadows.

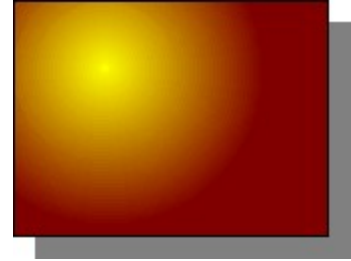

Adding transparency

You can make objects partly or fully transparent, or even with a varying degree of transparency (as a gradient).

Using styles

Suppose that you want to apply the same area fill, line thickness, and border to a set of objects. This repetitive process can be greatly simplified by the use of styles. Styles allow you to define a formatting template (a style) and then to apply that style to multiple objects. For more about styles, see Chapter 3 (Using Styles and Templates) for more information.

Special effects

With Draw, you can apply many special effects to objects and groups of objects. This section describes a few of these effects. Others include distorting, shadows, and transparency. See the *Draw Guide* for examples of the many effects available.

Flip an object

Select an object and click on the **Flip** icon . You will see a dashed line through the middle of the object.

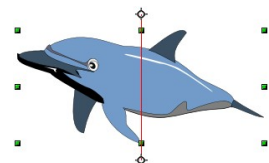

This dashed line is the **axis of symmetry**. The object will be reflected about this line. Move one or both ends of the line with your mouse to set the axis.

Then, grab any one of the eight green handles and move it across to the other side of the dashed line. The new position of the figure is shown dashed until the mouse is released.

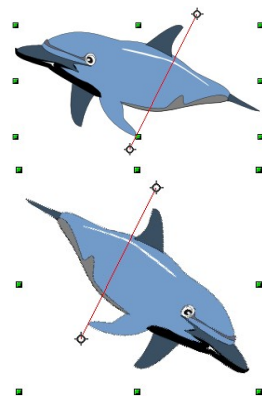

Note

If you hold down the *Shift* key while moving the line, the line will rotate in 45-degree increments.

Mirror copies

Officially, this useful command does not (yet) exist in Draw. It can, however, be easily emulated.

Move the axis of symmetry to the desired location of the mirror axis. Copy the object to the clipboard. Flip the object, then click on an empty area of the Draw screen in order to deselect the object. Paste from the clipboard to put a copy of the object in its original location and now you have a mirror copy.

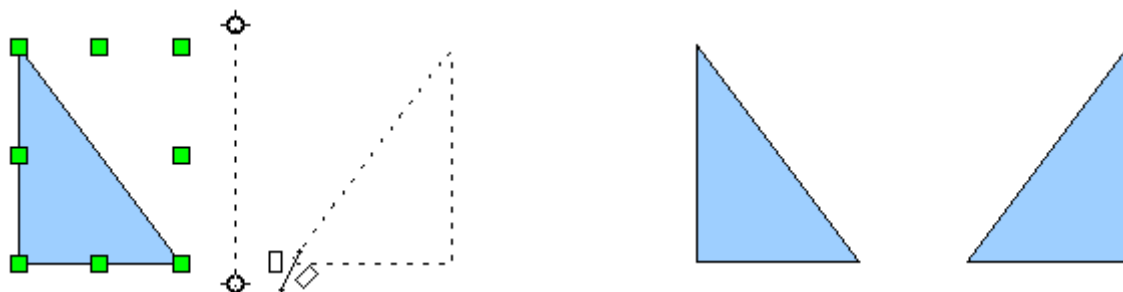

Distorting an image

There are three tools on the **Effects** menu that let you drag the corners and edges of an object to distort the image.

The **Distort** tool distorts an object in perspective, the **Set to Circle (slant)** and **Set in Circle (perspective)** tools both create a pseudo three-dimensional effect. See Chapter 4 of the *Draw Guide* for details.

Dynamic gradients

You can control transparency gradients in the same manner as color gradients. Both types of gradient can be used together. With a

transparency gradient, the direction and degree of an object's fill color changes from opaque to transparent (in a regular gradient, the fill changes from one color to another, but the degree of transparency remains the same). See Chapter 4 of the *Draw Guide* for details.

Duplication

Duplication makes copies of an object while applying a set of changes (such as color or rotation) to the duplicates. The result of a duplication is a new group.

To start duplication, click on an object or group and choose **Edit > Duplicate**. The dialog shown in Figure 26 appears.

The options chosen in Figure 26 applied to a blue rectangle produce the following result.

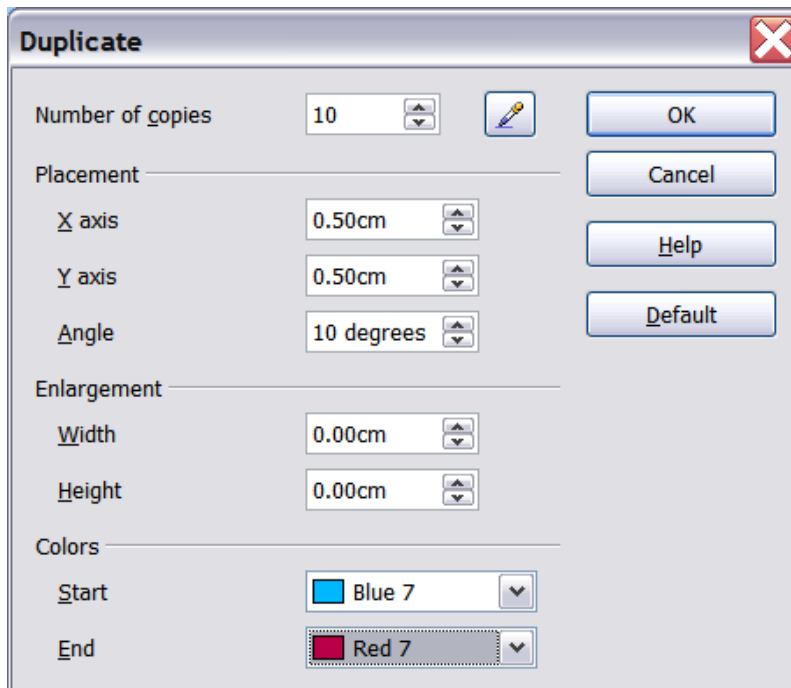
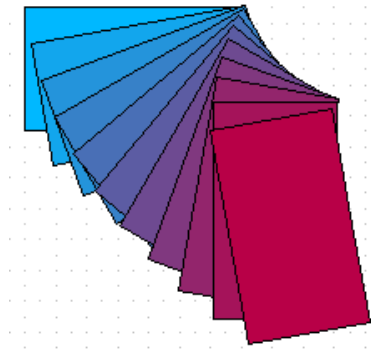
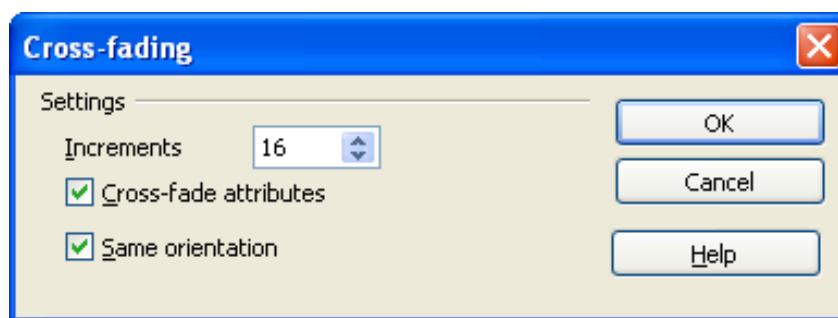

Figure 26: Duplicating an object

Cross-fading

Cross-fading transforms a shape from one form to another, with OpenOffice.org handling all of the intermediate transitions. The result is a new group of objects including the two end points and the intermediate steps.

To carry out a cross-fade, select both objects (hold the *Shift* key while selecting each object in turn) and then choose **Edit > Cross-fading**. The following dialog appears.



On the dialog choose the number of increments (transition steps). You probably want to have *Cross-fade attributes* and *Same orientation* both checked. The end result is shown in Figure 27.

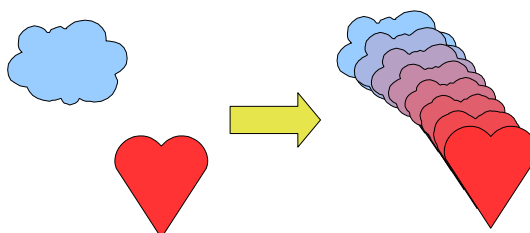

Figure 27: Cross-fading example

Combining multiple objects

Using Draw, you can combine drawing objects together in two distinct ways: *grouping* and *combining*. These two methods allow you to treat multiple objects as one unit, or to merge objects to form a new shape.

Grouping is like putting objects in a container. You can move them as a group and apply global changes to them. A group can always be undone and the objects that make up the group can always be manipulated separately.

A *combination* is a permanent fusion of objects leading to a new object. The original objects are no longer available as individual entities and the operation is not reversible.

Grouping by common selection

When several objects are selected, any operations you carry out are applied to all of the objects. For example, you can rotate a group of objects in its entirety. Groups obtained through common selection of several objects are undone as soon as you click outside the group. However, you can group objects and keep those selected objects grouped together.

Maintaining groups and undoing groups

To group selected objects, right-click and choose **Group** from the pop-up menu. You can also use the keyboard shortcut *Control+Shift+G* or choose **Modify > Group** from the menu bar.

When objects are grouped, any editing operations carried out on that group are applied to all members of the group. If you click on one member of the group, the whole group is selected.

The objects of a group retain their own individual properties. To undo a group, right-click and choose **Ungroup** from the pop-up menu, use the keyboard shortcut *Control+Alt+Shift+G* or choose **Modify > Ungroup** from the menu bar.

You can edit a member of a group individually without breaking the group. To do this, right-click and choose **Enter group** or double-click on the group.

Combining objects

In contrast to grouping functions, *combinations* create a new object; subsequent “un-combining” in the same manner as ungrouping is not possible. Select a collection of objects, then right-click and choose **Combine** from the pop-up menu.

After you have selected more than one object, the Merge, Subtract, and Intersect functions can be reached in the **Modify > Shapes** menu or through the group’s right-click menu under the heading **Shapes**.

Aids for positioning objects

Draw has various tools to help you arrange the objects with respect to each other:

- Moving an object to the front or to the back
- Aligning objects with respect to each other

- Distributing the distance and space between objects

See Chapter 5 (Combining Multiple Objects) in the *Draw Guide* for more information.

Editing pictures

Draw contains a number of functions for editing raster graphics (bitmaps)—for example, photos, scanned pictures, and so on—including import and export as well as conversion from one format to another. Draw can read in all the usual range of graphic file formats. However, it does not have the same capabilities as the specialized raster graphics programs like Adobe Photoshop or The Gimp.

See Chapter 6 (Editing Pictures) in the *Draw Guide* for details.

Working with 3D objects

Although Draw does not match the functionality of the leading drawing or picture editing programs, it does offer a wide array of tools and methods to produce and edit very good 3D drawings and pictures.

Draw offers two types of 3D objects: the ones carried forward from OOo version 1, *3D bodies*, and the ones newly introduced in version 2, *3D shapes*. Depending on which type you choose, there are different possibilities for further editing of the object (rotation, illumination, perspective). Setting up and editing 3D objects is simpler with 3D shapes than with 3D bodies, but 3D bodies currently allow for more customizing than 3D shapes.

See Chapter 7 (Working with 3D Objects) in the *Draw Guide* for details.

Inserting pictures from other sources

You can add pictures from several sources:

- The Gallery—see Chapter 11 (Graphics, the Gallery, and Fontwork)
- Directly from a scanner (**Insert > Picture > Scan**)
- Images created by another program, including photographs from a digital camera (**Insert > Picture > From File**)

Draw provides tools for working with bitmap images such as photographs: the Picture toolbar and the bitmap image management palette. See the *Draw Guide* for details and examples.

Exchanging objects with other programs

To save a Draw image in a foreign format, use **File > Export**. Draw can save to many graphic file formats, as listed in Chapter 3 (File Management).

You can also export Draw files to HTML, PDF, or Flash. PDF export is the same as for any part of OpenOffice.org, as described in Chapter 10 (Printing, E-mailing, and Exporting). Flash export creates a .swf file.

HTML export uses a conversion wizard that creates as many web pages as there are pages in your Draw document. You can optionally choose to display the pages in frames with a navigator and can set an index page. For more information, see Chapter 12 (Creating Web Pages: Saving Documents as HTML Files).